

# 2013 GOLDEN TEE GOLF

## Showpiece and Kit Installation Manual & User Guide



# WARNINGS AND NOTICES

## NOTICE

- This game is intended to be operated for amusement purposes only. It is not to be operated in violation of any federal, state, or local laws or regulations. As the owner and/or operator of this game you are responsible for its operation in compliance with such laws and regulations. The factory settings for this game may require adjustment in order to comply with the laws and/or regulations in the jurisdiction where the game is located. It is the sole responsibility of the operator to determine what laws and/or regulations are applicable and to make any adjustments to the game before operating it for its intended purpose.
- This manual and the information contained within is subject to change without notice.
- The Showpiece cabinet is intended for use with the Showpiece Integrated Stand (Model 304S).

## WARNING

- Use of unauthorized parts or making any unauthorized modifications will void the warranty and may result in the game operating in an unsafe or incorrect manner.
- If the supply cord is damaged, it must be replaced by a special cord or assembly available from the manufacturer or its service agent.
- This cabinet is not suitable for installation in an area where a water jet would be used. The cabinet must not be cleaned by a water jet.

## WARRANTY, REPAIR, AND RETURN POLICY

- 90-day warranty on all electronic components. All warranty periods begin on the date of purchase from Incredible Technologies, Inc.
- There is a minimum \$75.00 service charge for all non-warranty repairs or returns.
- For all servicing, return to Incredible Technologies, Inc.
- ANY non-factory repair or attempted repair voids warranty.

## RETURN MERCHANDISE AUTHORIZATION

- All returned merchandise must have a Return Merchandise Authorization (RMA) number marked clearly on the outside of the package.
- You must obtain all RMA numbers from Incredible Technologies. Please have the product's Cabinet Identification Device (CID) number available when calling for an RMA number.
- Merchandise returned without an RMA number will not be accepted.
- Warranty may be void if serial number or security labels are tampered with or removed. **Opening the Nighthawk Chassis system will void your warranty.**
- Advance replacement hardware will be shipped to the customer address on file unless specified otherwise.
- Advance replacement hardware will be billed to the customer until Incredible Technologies, Inc. receives the returned merchandise, at which time a credit will be issued.
- All repairs and/or replacements will ship as soon as possible after receipt or request (subject to availability).

## PAYMENT FOR AND STORAGE OF REPAIR MATERIALS

- Materials sent to IT for repair must be paid for according to current price schedules and in a reasonable time. Storage fees for repaired equipment will be charged at a rate of \$50.00 (Fifty US Dollars) per calendar month or fraction thereof after 90 (Ninety) days from notice to the customer that the repairs are complete. IT reserves the right to resell repaired equipment to cover accumulated storage charges when the accumulated storage charge reaches 100% (One Hundred Percent) of the repaired items' then-current replacement cost.

- INCREDIBLE TECHNOLOGIES, INC

# PERPETUAL SOFTWARE LICENSE

Incredible Technologies, Inc. ("IT,") hereby offers you ("Licensee") the right to install and use certain copyrighted computer software produced by IT under the following terms and conditions. This License shall govern the use of the software known as "Golden Tee GOLF 2012" ("Update") when applied as an update to pre-existing Golden Tee GOLF-equipped hardware ("GT Cabinets") equipped with an earlier version of the Golden Tee GOLF software ("Prior Version.")

## 1) Licensing Fee

The Licensing Fee ("LF") shall be as follows:

- US\$0.00 (Zero United States Dollars and zero cents.)

## 2) Term

The License shall be valid on the first date that both the LF is paid for the Update and it is installed on a GT Cabinet. If the Update has been offered or sold to you under the terms of a Term Software License, the terms of this License shall become applicable if and when the Term Software License terminates in favor of this Perpetual Software License, as set forth in the Term Software License. The term shall be perpetual and throughout the Universe for the Update on the GT Cabinet upon which it is installed at the time the LF is paid. Updates are not transferrable to any other GT Cabinet, for any reason. If a GT Cabinet with an Update is destroyed or otherwise taken out of operation, this License shall terminate.

## 3) License Rights

Licensee shall have the right to utilize the Update on authorized GT Cabinets in the normal course of business and as controlled by the Rules of ITNet, as set forth in a separate "Operator Agreement" document, the terms and conditions of which, where not conflicting with the terms and conditions herein, are hereby incorporated by reference. Updates may only be operated on GT Cabinets which are installed in commercial locations, as that term is defined by IT, and to which there is general access by all parties with a general right to enter the location where the GT Cabinet is operated.

## 4) Legal Operation

Updates include various features which may not be lawful to operate in any given jurisdiction. No provision of any feature, or its licensure to Licensee under the terms herein shall be deemed as advice that operation of that feature is lawful or not lawful in any given jurisdiction. Licensee shall make reasonable efforts to disable any user-adjustable feature which they know or should have known as not lawful to operate in the location where a GT Cabinet with an Update is being operated.

## 5) Termination and Rollback

In the event that this License is terminated for whatever reason, Licensee shall have absolutely no right to operate any GT Cabinet upon which an Update has been installed. IT reserves the absolute right, at its sole discretion, to terminate the operation of any GT Cabinet upon which an unlicensed Update is installed. If Licensee wishes to restore such a GT Cabinet to operating condition without acquiring a new License for the Update, IT will roll-back that GT Cabinet, at no charge to the Licensee, to the Prior Version upon return (at Licensee's expense) of the required hardware to IT's service center.

## 6) Governing Law and Jurisdiction

The validity and construction of this License and of the rights and obligations set forth herein shall be determined and governed by the laws of the State of Illinois. The parties hereby submit to the Jurisdiction of any state or federal court in Cook County Illinois. Licensees operating outside the borders of the United States of America, regardless of their citizenship or residency, explicitly agree to allow any assets they may have in the USA or any other foreign country to be attached, garnished, forfeited or otherwise reached by any legal act if, after due process of law, they are found to be liable to IT for damages by reason of breach of this License.

## 7) Warranty

If the Licensee discovers any physical defect in the media (disk, EPROM, flash media, etc.) on which the Update is distributed or in the documentation, which in the opinion of Incredible Technologies, Inc. (IT) prevents the product from being used as reasonably intended, IT will replace the media or documentation at no charge. The purchaser must return the item to be replaced, with proof of purchase, to IT within 90 days after taking delivery of the Update.

## 8) Disclaimer and Waiver of Remedies

Acceptance of this License and installation of the Update includes disclaimer and waiver of any and all implied, statutory, or common-law warranties, including warranties of merchantability and fitness for a particular purpose, and limits the purchaser's remedy to returning the Update to IT for replacement.

IT makes no warranty or representation, either express or implied, with respect to Updates, their quality, performance, merchantability, or fitness for a particular purpose. Updates are licensed "as is," and the Licensee, by installing the Update, assumes the entire risk as to their quality and performance other than as explicitly set forth herein.

Acceptance of this License and installation of the Update includes disclaimer and waiver of any and all direct, indirect, special, incidental, or consequential damages arising out of the use or inability to use the Update, even if advised of the possibility of such damages. The warranty and remedies set forth above are exclusive and in lieu of all others, oral or written, express or implied. No person, seller, dealer, agent, or employee is authorized to make any modification or addition to this limited warranty.

In jurisdictions which do not allow the exclusion of implied warranties or liability for incidental or consequential damages, acceptance of this License and installation of the Update includes stipulation that the most minimal requirements of the law of those jurisdictions shall govern any additional required additional rights of Licensee.

## 9) Severability

If any provision of this License shall be held by a court of competent jurisdiction to be illegal, invalid or unenforceable, the parties nevertheless agree that the court should endeavor to give effect to the parties' intentions as reflected in the provision, and the remaining provisions shall remain in full force and effect.

GOLDEN TEE® GOLF, ITS®, INCREDIBLE TECHNOLOGIES®, IT®, ITNet®, and IT incredible TECHNOLOGIES® are the properties of Incredible Technologies, Inc. All Rights Reserved.

© Copyright 2012 Incredible Technologies, Inc. All Rights Reserved. Unauthorized duplication is a violation of applicable law. All other marks are the properties of their respective owners. All rights reserved.



## Golden Tee GOLF 2013 Manual & User Guide

### TABLE OF CONTENTS

TABLE OF CONTENTS .....	1
NEW FEATURES FOR GOLDEN TEE GOLF 2013 .....	4
SHOWPIECE CABINET .....	5
Showpiece Cabinet Contents.....	5
Leg Leveler Adjustment .....	5
Mount Main Screen Display .....	5
Install Marquee.....	5
HDTV DIP SWITCH SETTINGS and NIGHTHAWK SYSTEM BOX.....	6
Video Connections for 720p HDTV .....	7
INSTALL SECONDARY MONITOR.....	8
ABOUT THE SECONDARY MONITOR.....	8
Final Check.....	9
Apply Power .....	9
General Cabinet Maintenance.....	10
Care and Cleaning of Rubber Bumper .....	10
Nighthawk Air Filter .....	10
Trackball Maintenance.....	10
Care and Cleaning of Cooling Fans and Vents .....	10
Showpiece Cabinet Repair Procedures .....	11
System Chassis Box .....	11
I/O Board.....	11
Cash Vault.....	12
Control Panel .....	13
Speakers .....	14
OFFLINE KIT CONTENTS.....	15
Recommended Tools.....	15
Installation Preparation .....	16
Preparing The Cabinet .....	16
Cabinet Selection.....	16
Preparing the Cabinet for Installation.....	16
Check High-Definition Television (Optional) .....	18
Electronics Installation.....	19
Install Nighthawk System box.....	19
Install Cabinet Identification Device (CID) .....	19
Install I/O Board .....	19
Control Panel Installation .....	20
Install Optional Control Panel for Existing IT Cabinets.....	20
Trackball and Button Preparation (For Most Kits).....	21
Control Panel Overlay Installation.....	22
Finishing The Control Panel.....	23
Complete System Box Connections.....	24
Attach I/O Power, Audio and USB cables.....	24
Attach Main Video Cable .....	24
Attach Power Cable .....	24
Complete I/O Board Connections.....	25

Connect JAMMA Harness.....	25
Connect the Control Panel Switches and Cable.....	25
Connect Coin Door Lamps.....	25
Connect the Trackball.....	25
Connect Audio Cables.....	25
Connect the USB Cable.....	25
Connect Medium or Low Resolution CRT Monitor.....	25
Connect VGA or SVGA CRT Monitor.....	25
Connect High-Definition Television.....	25
Connect I/O Power Cable.....	25
Check All Connections.....	25
Cabinet Graphics Installation.....	26
Marquee Installation.....	26
Coin Doors, Test Switch, and Volume Controls.....	27
Initial Power-Up.....	27
SYSTEM SETUP MENUS.....	28
Navigating The Menu System.....	28
Entering System Setup Mode.....	28
Selecting a Menu.....	28
Choosing a Menu/Option.....	28
Changing a Value.....	28
Main Menu.....	28
Collections & Earnings Menu.....	29
Do Collection.....	29
General Settings.....	30
Operator Adjustables.....	31
General Adjustments.....	31
Money Slot Adjustments.....	32
Sound Adjustments.....	32
Collection Settings.....	33
Reset to defaults.....	34
System Tests.....	35
Video Tests.....	35
Color Test.....	36
Contrast Test.....	36
Screen Size Adjustment.....	37
Sound Tests.....	37
Player Control Tests.....	37
Mechanical Meter Test.....	38
Hardware Tests.....	38
Hardware/Software.....	38
System Info.....	39
USB Info.....	39
Version Info.....	39
Check Hard Drive.....	40
Check Cooling.....	40
Troubleshooting Shortcuts.....	41
Golden Tee Settings & Audits.....	41
Golden Tee Settings.....	42
Casual Golf Spotlight Player.....	43
Spotlight Player Prize Settings.....	43
Golden Tee Audits.....	44
Golden Tee Audits.....	44
Player Cost Schedule.....	45
Reset Leaderboards & Records.....	45
APPENDIX A Troubleshooting Guide.....	46
APPENDIX B – SHOWPIECE Input/Output Connections (I/O Power, Trackball, etc.).....	51
APPENDIX B – KIT JAMMA, Trackball, and I/O Power Connections.....	52
APPENDIX C Replacement Part Numbers.....	53
APPENDIX D Nighthawk Component Diagrams.....	54
APPENDIX F Menu Navigation Shortcuts.....	65

Game Icon Descriptions.....	65
APPENDIX G Mounting Templates .....	67
Trackball Mounting Template.....	69
Button Templates.....	71

**NOTE**

**PLEASE RETAIN ORIGINAL SHIPPING BOX FOR SERVICE AND REPAIR.**

**Please be aware that with kit installations it is no longer possible to use CRT monitors with medium (512 x 384) or low (384 x 526) resolutions. If you have a low-resolution monitor it may be possible to switch it to a higher resolution. Check your monitor’s manual for capabilities.**

**Do NOT perform any installation or repair when the cabinet is powered on. Make sure the cabinet is unplugged from all power sources before and during installation.**

**Some game features may not be allowed in certain state or local jurisdictions. Be sure to check your local laws before activating or allowing any features that may be questionable in your area. Adjust game settings from the System Setup Menus. Refer to this manual for details.**

**Incredible Technologies cabinets are shipped with the USB cables disconnected from the I/O Board and the Cabinet Identification Device (CID). This prevents vibrations during shipment from damaging the contacts on the connectors. These cables must be connected before operating the equipment. IT recommends disconnecting these USB cables whenever transporting the unit.**

# NEW FEATURES FOR GOLDEN TEE GOLF 2013

In addition to five spectacular new 18-hole courses with advanced graphics, including Coconut Beach, Jack Rabbit Junction, Bear Lodge, Cape Haven and Sequoia Grove, Golden Tee GOLF 2013 includes the following features:

- **Select from all 40 Golden Tee courses** including the **5 all-new courses** for 2013! More courses and more choices equals more earnings!
- **New Ball Types and Club Sets** are available. Players will want them all as they experiment with matching equipment to their play style!
- **Dozens of New Clothing Items** for repeat play! Players can change into even more fun and outlandish new outfits!
- Some new courses feature real-time grass, which is a digitally enhanced grass that looks and plays like real grass. It appears in the rough of most courses.
- All-new in-game user interface featuring a beautiful new gel look that looks great without sacrificing functionality.
- All courses have new graphics filters that create an immersive experience for the player.
- New difficulty settings give offline players the same challenging game feel as online players.



# SHOWPIECE CABINET

## SHOWPIECE CABINET CONTENTS

(1) Golden Tee Golf Showpiece Cabinet

Shipped inside a plastic parts bag attached to the front of the cabinet:

- (1) Marquee Header
- (1) Power Cord
- (1) Game Manual
- (1) HDMI Cable

Shipped inside the cardboard sleeve on the top of the control panel:

(2) Marquee Header Brackets

### NOT Included with your Showpiece Cabinet

You will need to supply a digital display for the game's main monitor, and an appropriate stand or wall mount. Be sure that the stand or wall mount is UL listed. Incredible Technologies recommends a 42" HDTV that supports 720p for the best presentation, game play and earnings potential. A list of Recommended Mounting Solutions can be found under Purchasing Info and Specs at the following address on the IT web site:

<http://www.itsgames.com/itsgames/Products/GoldenTee/GTGolf2013/specs.jsp>.

### LEG LEVELER ADJUSTMENT

Once your game is in position at the location, it is necessary to adjust the leg levelers. The leg levelers will help stabilize the game on an uneven floor, and help it from moving or shifting during game play. The game is shipped with the two front and two rear leg levelers installed. Adjust the levelers as necessary to level and stabilize the game.

### MOUNT MAIN SCREEN DISPLAY

Position the Showpiece cabinet in front of an HDTV. Incredible Technologies recommends 720p flat panel HDTVs from 32" or larger.

The HDTV can be mounted to a wall or to an appropriate display stand. There are many different types of wall mounts and floor stands available through retail, wholesale and Internet outlets. Be sure that the wall mount or stand you select must be UL listed. Check [www.itsgames.com](http://www.itsgames.com) for some possible options. Be sure that the top of the Showpiece cabinet has at least 24" clearance in all directions. Insufficient clearance may result in damage to your display or player injury.

Recommended height for your display may vary depending on your location and player base. As a general rule, the minimum height of the bottom of the display viewing area should be 42" from the floor.

### INSTALL MARQUEE

Your Showpiece cabinet comes with a framed marquee header that can be easily attached to the top of your monitor. The brackets for the header are shipped inside a separate cardboard insert labeled *Parts – Do Not Discard* within the cabinet packaging. The insert is located on the top of the control panel.

First, attach the two brackets to the back of the universal mounting plate you are using for your HD display. The brackets share the same screws used to affix the display to the mounting plate, and are sandwiched between the plate and the back of the monitor. Once the brackets are in place, slide the marquee frame onto the clips on the two newly mounted brackets. Be sure the tab on the clips rest inside the channel on the marquee frame.

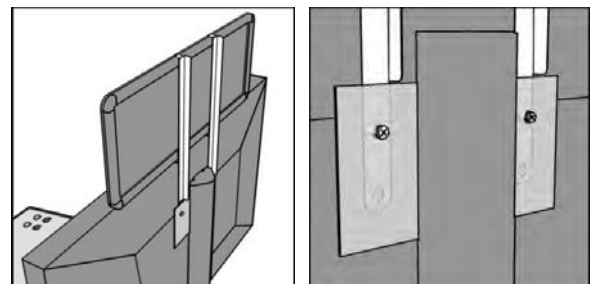

# HDTV DIP SWITCH SETTINGS AND NIGHTHAWK SYSTEM BOX

Before making any Nighthawk connections, make sure the USB cables are connected for the I/O Board and CID. See Complete System Box Connections for details.

## Nighthawk System Box

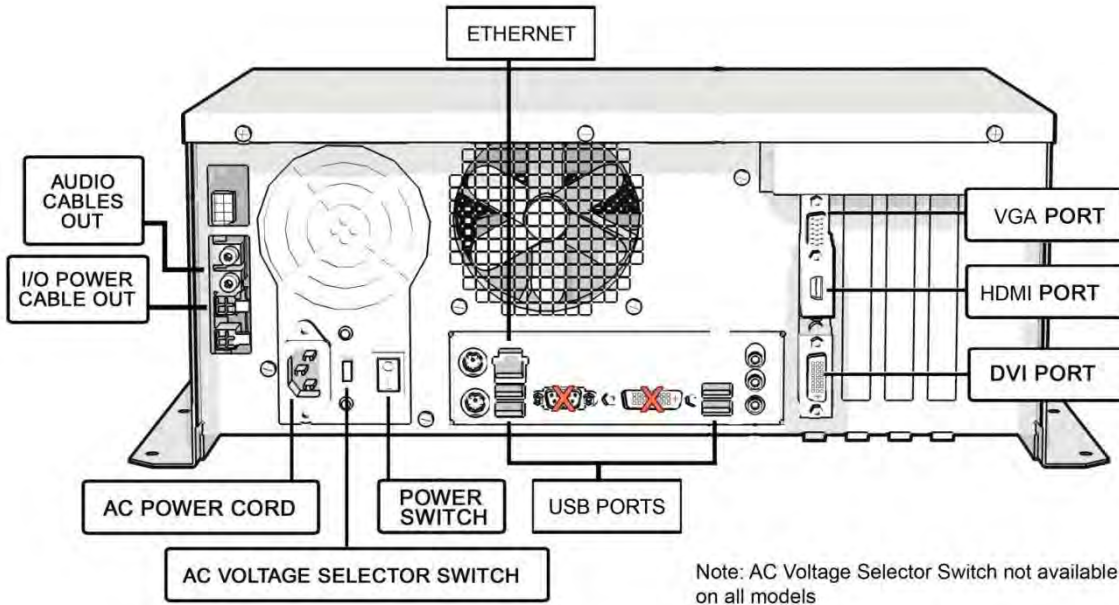

## DIP Switch Settings for HDTVs

The DIP switch settings in your Showpiece cabinet have been factory set to accommodate a 720p HDTV connected through HDMI cables. DIP switch bank Sw201 on the I/O Board controls the video resolution for the main monitor. If using a DVI-D or VGA connection, or for different resolutions, use this chart:

# HDTV MONITOR APPLICATION

## IMPORTANT NOTE

### RESOLUTION SETTINGS

<p>1 1280 x 720 (HDMI) 720p 2 OFF ON 3 4</p>	<p>1 1280 x 720 (SVGA) 720p 2 OFF ON 3 4</p>
<p>1 1280 x 720 (DVI-D) 720p 2 OFF ON 3 4</p>	<p>1 800 x 600 (SVGA) 2 OFF ON 3 4</p>
<p>1 800 x 600 (HDMI) 2 OFF ON 3 4</p>	

I/O CARD DIAGRAM FOR ORIENTATION

Sw201 Sw200 Sw202

OFF ON OFF ON OFF ON

Sw200 ALWAYS ON  
Do Not Change  
Settings shown for Showpiece

### ADDITIONAL SETTINGS

<p><b>Primary Monitor</b></p> <p>1 Primary Monitor has 16 x 9 Aspect Ratio 2 OFF ON 3 4</p> <p>1 Primary Monitor has 4 x 3 Aspect Ratio 2 OFF ON 3 4</p> <p><b>System Setup</b></p> <p>1 Enter System Setup Menus 2 OFF ON 3 4</p> <p>1 Exit System Setup Menus 2 OFF ON 3 4</p>	<p><b>Secondary Monitor</b></p> <p>1 Optional 2nd Monitor has 16 x 9 aspect ratio 2 OFF ON 3 4</p> <p>1 Optional 2nd Monitor has 4 x 3 aspect ratio 2 OFF ON 3 4</p> <p>1 Do Not Flip Optional 2nd Monitor 2 OFF ON 3 4</p> <p>1 Vertical Flip Optional 2nd Monitor 2 OFF ON 3 4</p>
--	--

Note: In the Additional Settings above, ONLY the ON switch matters for correct setup and operation.

### Notes:

A reboot is required when changing resolutions  
Video and audio connections to HDTVs vary, and may require additional cables not included with the Showpiece cabinet. Also, some displays may not support the resolution needed for your game. Check your display's manual for additional information.

# VIDEO CONNECTIONS FOR 720P HDTV

Golden Tee Golf 2013 supports 720p (1280x720) resolution. Be sure your HDTV is compatible. For any questions related to Showpiece cabinet connections, see the Showpiece Connections Guide at <http://www.itsgames.com/itsgames/Products/GoldenTee/GTGolf2013/specs.jsp>

If you plan to use a **Single HDTV** as your only video output, follow the instructions below.

## Connect to HDMI

Connect the HDMI cable (supplied) to the HDMI output on the Nighthawk system. Route the cable through the clip under the lock on the back wall, and down through the access panel on the back of the cabinet. Connect the other end of the HDMI cable to the proper HDMI input on your television.

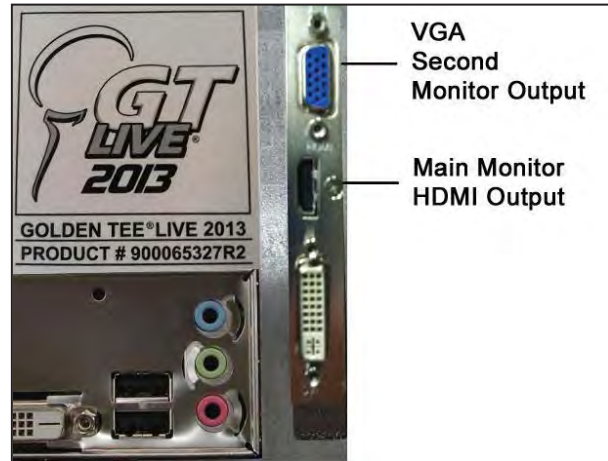

## Set Up Your HDTV

Refer to the HDTV manual to adjust the video signal to match the correct input for your game. Selecting the correct input is commonly found from a system menu accessed from the remote, or an Input Select button on the HDTV.

## Audio Connections for HDMI

The HDMI cable will also supply audio to the speakers on your HDTV. See Audio/Video Connections Table below for details on other connection types.

**Note:**

Be aware that when connecting a monitor with a resolution below 800x600 (and no lower than 640x480) you will need to use an analog audio connection. For more information see the Showpiece Cabinet A/V Connections Guide on IT's web site at <http://www.itsgames.com/itsgames/Support/Manuals>. Follow the setup instructions for VGA.

The current version of the Nighthawk System Box does not support monitors with a resolution below 640x480.

**Audio/Video Connections Table\***

Video Mode	Primary Video Connector	Audio	Secondary Video Connector
1280x720 (HDMI) 720p	HDMI with HDMI Cable	Digital - Via HDMI cable	VGA
1280x720 (DVI-D) 720p	DVI-D to HDMI	Analog - Via I/O Board or HDTV analog input	VGA
800x600 (HDMI)	HDMI with HDMI Cable	Digital - Via HDMI cable	VGA
800x600 (DVI-D)	DVI-D to HDMI	Analog - Via I/O Board or HDTV analog input	VGA
1280x720 (SVGA) 720p	DVI/VGA - VGA with adapter	Analog - Via I/O Board or HDTV analog input	HDMI - DVI-D
800x600 (SVGA)	DVI/VGA - VGA with adapter	Analog - Via I/O Board or HDTV analog input	HDMI - DVI-D
640x480 (VGA)	DVI/VGA - VGA with adapter	Analog - Via I/O Board or HDTV analog input	HDMI - DVI-D

\*Table applies to DB65AL motherboard systems with a Nighthawk System Box serial number 420000 and higher.

# INSTALL SECONDARY MONITOR

If you plan to use Two TVs for your video outputs, follow the instructions below.

## ABOUT THE SECONDARY MONITOR

Most Incredible Technologies games, including Golden Tee GOLF, support a secondary monitor. The second monitor in Golden Tee displays unique information, including game replays and advertising screens. Most other games from IT support a second monitor to display the main game screen, so more of your players can see the action. Golden Tee GOLF can also show the main display on the second monitor. See the System Setup Menus section of the Golden Tee 2013 manual.

Incredible Technologies recommends using a 16:9 computer monitor. In all cases, the second monitor requires a VGA connection from the Nighthawk system box to the digital display of your choice. See the Sw202 DIP switch settings on the previous page to adjust the display.

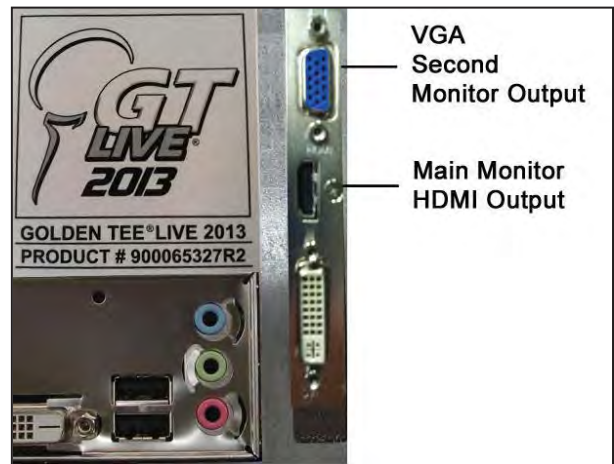

**PRIMARY VIDEO (HDMI to HDMI):** Connect the HDMI cable from the HDMI Output on the back of the Nighthawk to the HDMI Input on the back of the HDTV.

### SECONDARY VIDEO (VGA)

Connect the SVGA cable from the upper port to the VGA Output on the back of the second television. Route the cable through the clip under the lock on the back wall, and down through the access panel on the back of the cabinet. Common input label names for VGA are RGB, Computer or PC.

### SET UP YOUR HDTV

Refer to the HDTV manual to adjust the video signal to match the correct input that your game is connected to. Selecting the correct input is commonly found from a system menu accessed from the remote, or an input select button on the HDTV.

# FINAL CHECK

## APPLY POWER

Connect the power cable to the socket on the back of the cabinet. Then plug the cable into a 3-pronged, grounded wall socket. Locate the power switch on the back of the cabinet and turn it ON.

**Note:** If the supply cord is damaged, it must be replaced by a special cord or assembly available from the manufacturer or its service agent.

Watch the game carefully when you first turn it on. Look and smell for smoke. Turn it OFF immediately if there is smoke. Make sure the fan inside the system box is running and the LEDs on the I/O Board are flashing. If not, something is wrong, turn off the game.

### Check the Cabinet ID Device (CID) Number

Watch the screen during boot-up and wait for the Golden Tee boot verification screen to appear. Note the Cabinet ID Number (CID) that appears on this screen, and verify that it matches the CID number printed on the back of the cabinet. The screen will automatically time out and boot-up will continue.

### Check the Coin Switch and Bill Validator

Try the coin switch. Drop quarters or tokens through to check the coin mechanism. Insert a dollar bill into the bill validator and listen for the credits to ring up. Make sure the game is adding credits and the correct quantity. You can use the Player Control Test by pressing the System Setup button inside the coin door and entering the *System Tests Menu*. Make sure all of the controls work.

### Cabinet Temperature

The state of the art Nighthawk hardware is extremely powerful, and therefore generates a substantial amount of heat. Measures have been taken to keep the various components cool during normal use. If overheating occurs, game play and hardware longevity may be affected. Use the Check Cooling menu in the System Setup menus to monitor the temperature within your cabinet. Enter System Setup by pressing the System Setup button inside the outer door of the coin vault. Once at the main System Setup menu, use the trackball and Start button to select *Troubleshooting Shortcuts*, then *Check Cooling*.



### Custom Adjustments

Upon initial power-up, the game will initialize to factory default settings. These settings affect game elements such as number of credits per coin, volume settings, etc. The System Setup section in your game manual will describe how to alter these settings and view the system audits or run system tests.

## GENERAL CABINET MAINTENANCE

Games that are in good working condition, with clear monitors, clean control panels and working trackballs will make more money than a machine in poor condition. It is definitely worth your time and attention to protect your investment with a little common care. Each week, clean the display and wipe down the control panel to bring back that new game look. Test the trackball and buttons regularly to make sure they are playing properly. And perhaps most important, make sure the coin mechanisms and bill acceptors are in good working order.

### CARE AND CLEANING OF RUBBER BUMPER

The rubber bumper on the front of the cabinet's control panel is made from durable nitrile rubber. Clean it using a mild soap and water solution or blue window cleaner.

### NIGHTHAWK AIR FILTER

The Nighthawk System Box comes equipped with an external electrostatic air filter. This filter is held in place by a metal bracket, attached to the system box. The filter prevents debris from entering the system box and damaging the electronic components. A clogged filter will impede airflow, thus building up unwanted heat which can cause damage to your hardware. Be sure to check this filter at least once a month. Remove the filter by sliding it out of its housing. Shake off excess dirt and if necessary clean it with soap and water. Be sure the filter is completely dry before reinstalling the filter.

### TRACKBALL MAINTENANCE

The trackball will require periodic maintenance to assure optimum performance. In most cases the inside of the trackball simply needs to be cleaned of any accumulated dust and debris. See page 13 for Trackball Replacement.

To access the inside of the trackball, remove the 6 Phillips head screws that hold the trackball together and remove the top cover. Clean out any dust and debris inside the trackball. Polish the rollers and remove any foreign material that may be on the rollers. Do not lubricate the bearings, as this will only attract more dust. If the bearings do not spin freely it is best to replace the bearing assembly. Inspect the rollers for any nicks that may cause poor performance and replace if needed. Inspect the ball for any nicks and replace if needed. Parts can be obtained from Happ Controls and is an economical option rather than replacing the entire trackball assembly.

It is critical that the green field ground wire be properly connected to field ground. This prevents the trackball from building a static charge that can cause the game to lock up or reset. A static discharge can also damage the trackball's electronic components, as well as the main system.

### CARE AND CLEANING OF COOLING FANS AND VENTS

The hardware that runs Golden Tee GOLF is quite sophisticated, and many of the chips and processors will get hot very quickly. Like your desktop PC, the Golden Tee GOLF hardware needs adequate ventilation to work properly. Dust and dirt can be a major cause to overheating and will lead to costly repairs. At least once a month, check to make sure the cabinet and system box fans are working and free of dust and debris. Use a vacuum to clear all the ventilation holes on the cabinet at this time as well.

#### **CAUTION:**

Incredible Technologies cabinets are shipped with the USB cables disconnected from the I/O Board and the Cabinet Identification Device (CID). This prevents vibrations during shipment from damaging the contacts on the connectors. These cables must be connected before operating the equipment.

IT recommends disconnecting these USB cables whenever transporting the unit.

# SHOWPIECE CABINET REPAIR PROCEDURES

## SYSTEM CHASSIS BOX

The Nighthawk Chassis houses most of the game electronics and hardware in one box that can be easily installed. As with all electronic equipment, the Chassis box should be handled with extreme care. Shock, severe temperature, or sudden impacts can damage the internal components that require costly repair.

**Note:** Turn off power to the cabinet and remove the power cord from the back of the cabinet when performing any of the following.

### System Chassis Removal

1. Unlock the control panel and open to expose the Nighthawk system box.
2. Disconnect all connections to the system box. Be sure all wires and connectors are clear and out of the way. Label the connectors for easy reconnection.
3. Loosen the 6 ¼" hex-head screws that secure the system box.
4. Carefully lift the system box off the screws and up out of the cabinet.

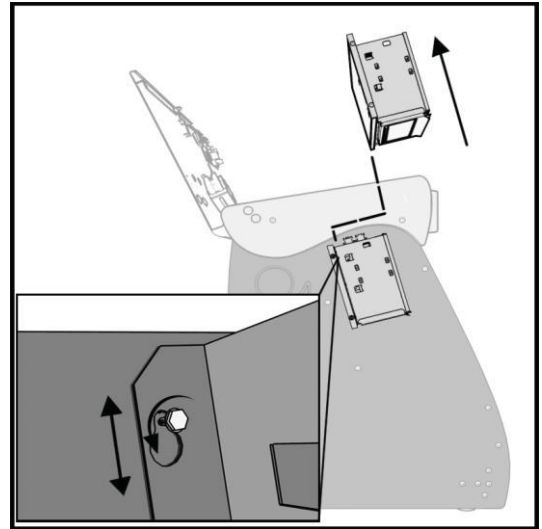

### System Chassis Installation

1. Unlock the control panel and open to expose the inside of the cabinet.
2. Align the system box onto the 6 mounting screws of the internal slanted panel. The connection ports face up. Once the system box is in place, tighten the 6 ¼" hex-head screws to secure the box to the panel.
3. Connect the required connections. See the Connections Diagram for more details.

## I/O BOARD

**Note:** The I/O Board is game title specific and is not interchangeable with other game titles produced by Incredible Technologies on this system. Dedicated and Retrofit Kit I/O Boards are different and are not interchangeable.

### I/O Board Removal

First, unlock the control panel and open to expose the interior of the Showpiece cabinet. Disconnect all connections from the I/O Board. Label the connectors for easy reconnection and move them safely out of the way. Next, remove the six ¼" wood screws that secure the board to the interior left side of the cabinet (as you face the game). Carefully remove the I/O Board from the cabinet.

### I/O Board Installation

Place the I/O Board in the proper location on the interior left side of the cabinet (as you face the control panel of the game). Be sure it is oriented properly so the cables reach the board (the USB port on the I/O Board facing the top of the cabinet). Secure the I/O Board to the side of the cabinet with the six ¼" wood screws. Use the factory mounting holes if at all possible. Be sure the board does not "bow" or is not stressed in any way. Once mounted, connect the appropriate connections.

## Cabinet Identification Device (CID)

This device contains a specific ID number that identifies your cabinet. The CID is a permanent number and must be connected to the main system box via the USB cable and working properly in order for the game to operate.

## CID Removal and Replacement

If for some reason you must replace the CID, disconnect the USB cable from the CID. This is the only connection to the CID. Next, remove the four ¼" wood screws that secure the CID to the interior left side of the cabinet (as you face the game). The CID is located above the I/O Board. To install a CID, mount the CID in the proper location using four ¼" wood screws. The CID should be mounted so the USB port is facing the top of the cabinet and the electronics are facing the wall.

**Note:** The Cabinet Identification Device should **NEVER** be removed from the cabinet, even when replacing any of the other components. The CID is the cabinet's PERMANENT Identifier, regardless of any other components.

## CASH VAULT

The Cash Vault has been designed for optimal security. With the double-locking doors, service technicians can read meters and enter System Setup mode with no access to the cash box.

## Cash Vault Removal and Replacement

1. Unlock and open the outer door of the Cash Vault.
2. Using a T-15 Torx wrench, unscrew the card reader/button plate located on the right side by removing the four #8-32 screws located at the top and bottom of the plate.
3. Disconnect the connectors for the coin meter and buttons.
4. Remove the plate and set it aside.
5. Remove the coin bin and the bill validator magazine to make it easier to work inside the vault.
6. Unplug the bill validator cables, and push the cables for the bill validator, buttons, and coin meter through the 2 holes located in the back of the vault.
7. The Cash Vault is attached by upper and lower locking brackets. These are each attached with two socket-head screws located within the vault.
8. Locate the socket-head screws on the top and bottom locking brackets. Remove the two bottom screws using a 9/64" hex key and remove the bottom locking bracket. Make sure to note how it was installed.
9. Remove the two top screws and remove the top locking bracket, again noting how it was installed.
10. You can now pull the entire vault assembly out from the front of the cabinet. The vault is attached with foam tape, so it will need to be pried out or pushed from behind to loosen the adhesive.
11. Reverse the procedure to install the new door.

## Locks

The outer lock is a secure T-handle lock, commonly used in vending. To open, insert the key and turn it clockwise until the lock-handle pops out. Next, rotate the lock-handle clockwise 90 degrees to open the outer door.

The inner door has a lock installed above the System Setup button. This lock is unlocked by turning the key 90 degrees clockwise.

## Volume and Service Buttons

Mounted inside the outer door are controls for Volume and System Setup. Press the Volume Up button to increase the loudness of the sounds on the game, and press the Volume Down button to make your game quieter. Press the System Setup button to access the game's software menu system. The System Setup menus cover a variety of important areas including collections, tests, game adjustments, and optional settings.



## Bill Acceptor

The dedicated cabinet ships with a MARS AE2481 D5 bill acceptor and is mounted on the cash vault door. The default DIPswitch settings for this acceptor are ON = 1, 2, 4-7 and OFF = 3, 8.

### Bill Acceptor Removal

Disconnect the cable to the bill acceptor. Remove the four 11/32" sized nuts from the mounting studs. Disconnect the ground wire from the one lower stud. Then gently pull the acceptor off the studs from the back side of the coin door.

### Bill Acceptor Installation

From the back side of the coin door, place the bill acceptor onto the four mounting studs. The faceplate will protrude out the front of the coin door. Place the field ground wire on a lower stud, and install the four 11/32" sized nuts on the mounting studs and tighten. Next, connect the bill acceptor cable in the cabinet to the mating cable on the bill acceptor itself.

### Stacker Removal

A blue slide switch is located at the bottom of the stacker. Engaging it allows the stacker to be removed.

## Coin Mechanism

### Coin Mechanism Removal

Loosen the two finger screws to release the securing braces. Slide the upper brace upward, and the lower brace downward. The mechanism should pull straight out.

### Meter

This 5-volt device is mounted behind the card reader plate next to the inner door of the coin vault. One lead of the meter is connected to a +5 volt source and the other lead is connected to the appropriate signal wire. An additional opening is available just below the meter, if a second meter is desired.

## CONTROL PANEL

Opening the control panel provides access to all game controls and hardware components. To open the control panel, simply use the supplied key in the lock on the back of the cabinet and lift from the back. The control panel is hinged in front and will stay open when fully extended.

### Soft Power Switch

A "soft power" switch has been added to the underside of the control panel, to assist in the update process. This switch will turn off power to the cabinet so you don't have to reach around to the main power switch located on the back of the cabinet.

**Note:** If you turn power off using the Soft Power Switch, you **must** use this same switch when turning power back on.

### Trackball Replacement

To replace a trackball, open the control panel and remove the 4 long screws holding the trackball in place. Be careful not to lose any of the screws, washers and lock washers. Disconnect the wire harness and ground wire and remove the old trackball. Position the new trackball in the proper orientation over the existing standoffs. Make sure that the arrow on the trackball that points to the monitor is pointing up. Replace the 4 long screws and washers. Do not over tighten! Screw in until the lock washer is fully compressed. Reconnect the wiring connector and ground wire.

**Note:** The field ground wire is critical to avoid electrical problems and assure optimal performance.

## Button Replacement

All of the buttons on the control panel require a 1 1/8<sup>th</sup> inch hole, and are pre-drilled on the dedicated control panel. To remove a button, disconnect the wires from the button assembly by sliding the wires off of the micro switch posts. Next carefully twist the micro-switch assembly off of the button posts. Finally, unscrew the nut to remove the button from the control panel.

Place the new button assembly into the hole and position the smaller side of the micro-switch housing to face the rubber bumper, angled towards the middle. Tighten the supplied nut using a pushbutton wrench. Do not over tighten. Install the micro-switch by snapping it onto the pushbutton assembly by hand. Position the assembly so the micro switch posts face the rubber bumper, angling towards the middle. Reconnect the wires by sliding the wire assembly onto the contact posts of the appropriate micro switch. See the wiring diagrams in the back of this manual.

## L.E.D. Lighted Buttons

The Help and Options buttons on Golden Tee GOLF are Light Emitting Diode buttons. The housing for the L.E.D. snaps into the back of the button assembly. The L.E.D. must be installed properly for the light to function properly. The Anode/positive side of the L.E.D. is connected to the +5 volts, and the Cathode/negative side of the L.E.D. is connected to the appropriate signal wire. The L.E.D. slides into the housing and the housing is marked Positive and Negative. See the lamps connector J202 in the cabinet wiring diagram in Appendix D.

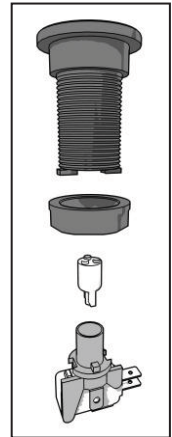

## Control Panel Removal

To remove the control panel from its hinge, Disconnect the trackball cable, field-ground wire, and the control panel interconnect connector to the I/O Board. Remove the screw that attaches the safety cable to the control panel. Remove the four 1/4" screws holding the panel to the hinge.

## Control Panel Graphics Removal

The control panel artwork has been screened onto a solid sheet of polycarbonate, which is resistant to scratches and burns. Unfortunately long exposure to excessive situations may damage the surface over time. To remove and replace this piece, the pushbutton and trackball assemblies must first be removed. Separate the polycarbonate piece from the wood portion of the panel by starting at one corner and slowly peeling the two apart. The overlay has adhesive on the entire surface and will take some force to separate the pieces due to the adhesive. Once removed, the graphic overlay will not be able to be used again.

## Control Panel Graphics Installation

To install a new polycarbonate graphics overlay, make sure the wood control panel surface is clean, smooth, and free from glue, dirt and debris. Remove the paper protecting the adhesive from the new artwork/cover panel. Carefully place it on the wood panel, aligning it properly. Press and smooth firmly to assure that it is secure. Replace the buttons and trackball in the correct orientation.

## SPEAKERS

The speakers are mounted in the bottom front of the cabinet, just below the coin vault. Sounds and speech are important aspects to the play experience and should be adjusted and maintained for optimal results. Make sure your speakers are in good working condition, are wired correctly, and are grounded properly to avoid buzz or hiss.

## Speaker Access

In order to reach the speakers, unlock and raise the hinged control panel. The speakers are located just below the coin vault. Remove the 4 nuts with an 11/32" nut driver to remove the speakers from their mounting.

**Note:** Both speakers must be identically wired to work properly. For optimal sounds, both speakers must be in phase with one another. Be sure the positive wire is connected to the positive terminal of each speaker and the negative speaker wire is connected to the negative terminal of each speaker.



## OFFLINE KIT CONTENTS

*Please refer to the IT part numbers in Appendix C when ordering parts.*

- (1) Golden Tee 2013 Nighthawk System Box
- (1) I/O Board Assembly Golden Tee 2013
- (1) Cabinet Identification Device (CID) for Golden Tee 2013
- (1) HDMI cable
- (1) DVI to VGA Adapter
- (1) SVGA Cable
- (1) Trackball Cable
- (1) Input/Output Connections Cable
- (1) Help Option Cable
- (1) I/O Power Cable
- (1) 6' 2 RCA to 2 RCA Audio Cable
- (2) 6' USB Cable
- (1) A.C. Power Cable
- (1) 3" Trackball, White
- (1) Trackball Plate for 3"
- (1) Card Reader Blanking Plate
- (1) Pushbutton Assy., Red
- (4) Pushbutton Assy., White
- (1) Pushbutton Assy., Blue Round Illuminated
- (1) Pushbutton Assy., Yellow Round Illuminated
- (1) Marquee, Golf Golf 2013
- (1) Control Panel Graphics Overlay, Golden Tee GOLF 2013
- (1) GoldenTee.com Card
- (1) Manual, Golden Tee GOLF 2013
- (1) Quick Install Guide Golf GOLF Kit
- (1) Parts bag containing miscellaneous hardware
- (1) \*Fully-dressed Control Panel (Includes: assembled trackball, control panel overlay and buttons as a unit)

\*There is an additional fee for kits with the fully-dressed control panel. If the fully-dressed control panel was not ordered, the kit includes ONLY: trackball, control panel overlay and loose buttons NOT assembled.

## RECOMMENDED TOOLS

Have the following tools ready before you begin to install this kit:

- 1/4", 11/32" and 7/16" Sockets or Nut Drivers
- Phillips Head #2 Screw Driver
- 3/16", 7/32" and 9/32", or 5/16", 3/8", and 3/4" Drill Bits
- 1 1/8" and 3 1/2" Hole Saw or Drill Bit
- Small Flat Blade Screwdriver
- Jig/Sabre Saw
- Router
- Push Button Nut Socket or Large Adjustable Pliers
- X-acto® Knife or other Sharp Knife/Razor Blade
- Wire Cutters
- Scissors
- Tape Measure
- Putty Knife

- ❑ Decal Roller/Squeegee
- ❑ Liquid Window Cleaner & Cleaning Cloth
- ❑ Vacuum Cleaner
- ❑ Any tools needed to remove parts from your existing cabinet not listed above.

## INSTALLATION PREPARATION

### BEFORE YOU START...

Before you install the Golden Tee GOLF kit into your cabinet there are a few things you should check first:

1. Check to make sure your existing cabinet's monitor, speakers, AC power cord, lights, bill acceptor and coin mechanisms work. Replace or repair where necessary.
2. Check to make sure all the necessary parts are included in your kit. If any are missing/damaged please contact IT's Technical Support at 847-870-7027 x121.
3. Check to make sure cabinet is wired with standard earth grounded AC plug compatible with local building codes and/or safety requirements. If not, have a qualified electrician install one (not provided).
4. Have all the necessary tools available to install this kit. Refer to the recommended tools list to make sure you are prepared before you start.
5. Make sure any parts of the system (lights, monitor, etc.) are not plugged in. Working with any part of the system plugged in or powered on can be dangerous.
6. Keep in mind that it's been proven that the higher quality of work put into a kit installation results in a higher earning game. Make sure you have plenty of space, time, and focus to put into this kit installation.

## PREPARING THE CABINET

### CABINET SELECTION

You can choose either a new cabinet or a used cabinet for your GOLF game. Reusing a cabinet is a cost-effective way to maximize the return on your initial investment. In either case, all you need to provide is the cabinet with a monitor, JAMMA harness, coin and bill acceptors, working fluorescent/marquee lights, and speakers.

When selecting a cabinet, keep in mind that a larger control panel allows you to mount the trackball farther from the monitor. This prevents players' hands from hitting the monitor glass when rolling the trackball forward, and will earn better than a smaller control panel closer to the monitor. An older-model Golden Tee Golf dedicated cabinet is ideal for this purpose.

If using an older IT cabinet made before 2005, such as Golden Tee 3D or Golden Tee Fore, consider ordering a new Control Panel from Incredible Technologies. These control panels come pre-installed with controls and graphics, and can save you considerable time and money through easy installation.

### PREPARING THE CABINET FOR INSTALLATION

Follow these steps to prepare your cabinet before installation:

1. Remove the following from the cabinet: Main Logic Board(s) (and hard drive if present), Control Panel, Monitor Viewing Glass, Marquee, and Power Supply. Now is a great time to clean both sides of the monitor viewing glass and monitor screen to ensure a clear view of the game.
2. Thoroughly clean out your cabinet. Remove all of the old buttons, joysticks, etc. **DO NOT** remove monitor and speaker wires or the wires that were previously hooked up to the control panel.
3. Remove the old graphics and adhesive from the cabinet including the control panel.
4. For a fresh look and best earnings, painting is highly recommended. Spray painting gives a better finish, but if an airbrush or paint sprayer is unavailable a roller is second best. Remember to cover all exposed surfaces not to be painted. When not installing into an existing Golden Tee Fore! dedicated cabinet, the recommended color choice is black.
5. Make sure to have the sides of the cabinet and the control panel as smooth and flat as possible to allow for a higher quality finish when applying the control panel background, labels, and side decals.

6. The "new game look" should always apply to the inside of your game as well. A few wire ties and shrink tubing on your harness, some fastening hardware on your subassemblies, and a sweep with the vacuum cleaner will help ensure that glitches do not occur.

### **Check JAMMA Harness and Wiring**

The GOLF Kit comes with a special I/O Board that uses your cabinet's existing JAMMA wiring harness. Make sure your existing wires and connectors are in good working order. Check the JAMMA wiring diagram in Appendix B - Kit.

### **Check Coin Mechanisms and Bill Acceptor**

Make sure your coin mechanisms and bill acceptor are functioning properly, and your coin box and stacker are in good condition. You want to make sure your game will accept money when players are ready to play.

### **Check Coin Door Connections**

Your cabinet should already be wired correctly through the JAMMA connector. Now is a good time to make sure your game can accept money. Check the JAMMA pinout chart in Appendix B - Kit for the correct wire colors and pins. Trace the wiring to their sources and make sure they are connected properly and securely. Be sure the wires are away from the coin door where they can be pinched or crimped.

### **Check CRT Monitor**

GOLF supports a number of resolutions, including SVGA (800 x 600), VGA (640 x 480), medium resolution (512 x 384) and low resolution (384 x 256) CRT monitors. The factory-installed monitors in all older IT cabinets are compatible with GOLF. However, to take advantage of the best and most current quality available, it is recommended to upgrade to an SVGA compatible monitor or high-definition television.

Operating GOLF at the highest possible resolution will give your game the best results (and revenue). Many standard cabinets contain a medium-res. or VGA monitor already. If you have a low-res monitor, it may be possible to switch it to a higher resolution. Check your monitor's manual for capabilities. If not, you should consider upgrading to a newer monitor or high-definition television.

Check your CRT monitor for a DB15 VGA connector. If your current monitor has a DB15 VGA connector, it is capable of VGA or SVGA resolutions. Check your monitor's manual on how to switch the monitor to VGA mode. Make sure the video dip switches on the I/O board match the resolution that the monitor is expecting. Plug the video cable from the Nighthawk System box directly into the monitor. Be sure to disconnect the old composite sync video cable from the monitor.

When operating with an SVGA or VGA monitor, GOLF uses the standard VGA sync timing and signals. When operating with medium resolution or low resolution monitors, which are common in older Golden Tee Fore! dedicated cabinets, GOLF operates with composite negative serrated sync.

**NOTE:** In all cases a horizontal mount raster scan monitor is required.

**CAUTION!** Monitors are extremely dangerous and can result in severe injury. Make sure you follow and observe all safety precautions as outlined in your monitor's manual. ALWAYS disconnect the power to the cabinet before working on or around the monitor.

# CRT MONITOR APPLICATION

## IMPORTANT NOTE

### RESOLUTION SETTINGS

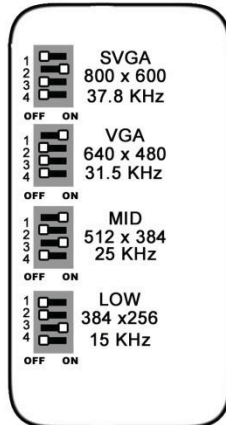

### I/O CARD DIAGRAM FOR ORIENTATION

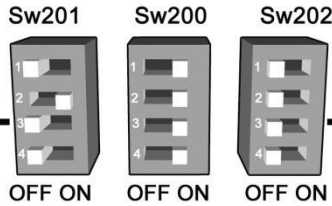
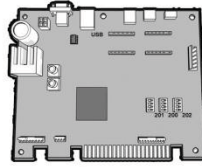

ALWAYS ON  
Do Not Change

### SECONDARY SETTINGS

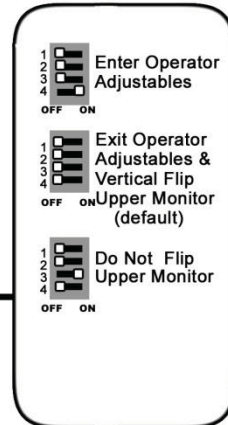

**NOTE:** In all cases a horizontal mount raster scan monitor is required.

**CAUTION!** Monitors are extremely dangerous and can result in severe injury. Make sure you follow and observe all safety precautions as outlined in your monitor's manual. ALWAYS disconnect the power to the cabinet before working on or around the monitor.

## CHECK HIGH-DEFINITION TELEVISION (OPTIONAL)

GOLF supports a 720p resolution that is compatible with newer flat-panel LCD digital televisions. In addition, both 16:9 and 4:3 aspect ratios are supported. Refer to the Showpiece section of this manual for details on connecting video and audio to a 720p HDTV.

**NOTE:** Video and audio connections to these displays vary, and may require additional cables not included in the GOLF kit. In addition, some televisions may not support the resolution needed for GOLF. Check your television's manual for additional information.

**WARNING:** Be sure top of cabinet has at least 18 inches or 45.7 centimeters of clearance in all directions. Insufficient clearance may result in damage to monitor or player injury.

# ELECTRONICS INSTALLATION

## INSTALL NIGHTHAWK SYSTEM BOX

The Nighthawk System box houses most of the game electronics and hardware into one box that can be easily installed. **Verify that the Nighthawk System box Power Switch is in the "ON" position.**

1. Locate the area on the floor where the system box will be placed. Make sure there is enough clearance to plug in cables.
  - The Nighthawk System box measures 19" W x 7" H x 11" D.
2. Relocate and secure any wires to make room for the system box.
3. Place the system box so it sits flat on the floor and does not pinch wires. Be sure there will be sufficient air flow to the system box. Overheating can damage your system.
4. Mount the system box with 6 - #6 x 3/4" Hex Washer Head Sheet Metal Screws.

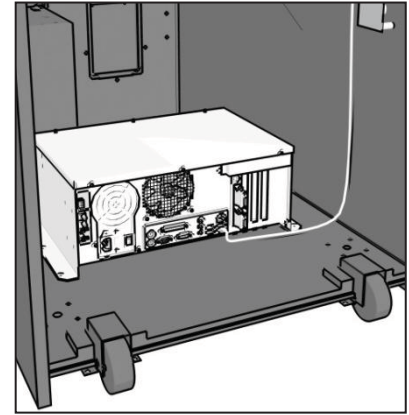

## INSTALL CABINET IDENTIFICATION DEVICE (CID)

The Cabinet Identification Device or C.I.D. is an innovative and important component. This device permanently identifies your cabinet as GOLF. It should remain even if another component such as the I/O board or system box is replaced. The C.I.D. has a unique number to individualize the cabinet and is referred to as the Cabinet Identification Number.

1. Attach the C.I.D. to the inside side of the cabinet using the 2 - #6 X 1" Hex Washer Head Sheet Metal Screws. Mount so the port is facing up and the electronics face the wall.
2. Attach the USB cable from the Nighthawk System box.
  - Place the included Cabinet Identification Number on the back of the cabinet for future reference. **Refer to this number to track your equipment and whenever you are calling in for service.**
  - The Cabinet Identification Number is displayed in the operator menus in the lower right hand corner, and is labeled as Game ID. It is also displayed near the bottom of the initial boot-up screen.

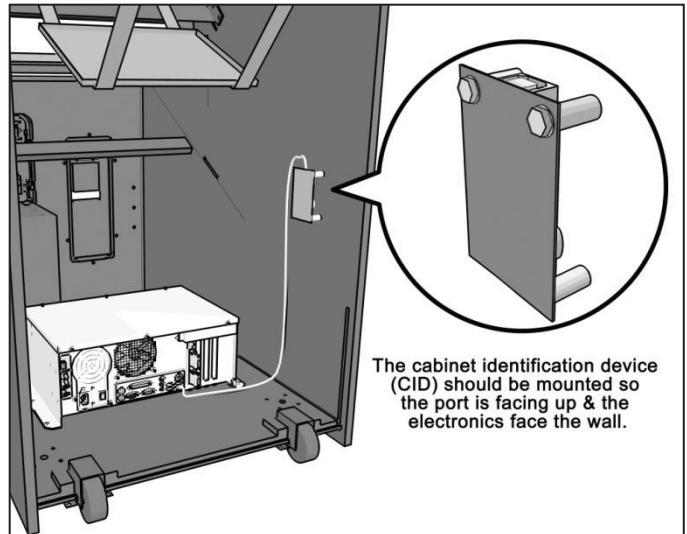

The cabinet identification device (CID) should be mounted so the port is facing up & the electronics face the wall.

## INSTALL I/O BOARD

**NOTE: Before installing any electronics make sure cabinet power switch is in the OFF position and the cabinet power is unplugged from the wall.**

GOLF comes with a specially designed I/O board that works with your cabinet's already installed JAMMA harness. The I/O board is used as a connection interface between the JAMMA and the Nighthawk System box.

Mount the I/O board inside the cabinet using 4 of the 6 x 3/4" Hex Washer Head Sheet Metal Screws, 1 in each corner. The existing JAMMA harness edge connector will attach to this board. Do not attach cables at this time.

**NOTE: Route all cables AWAY from the I/O Board. Laying cables on top of or below the I/O Board will result in unwanted noise or static during the game.**

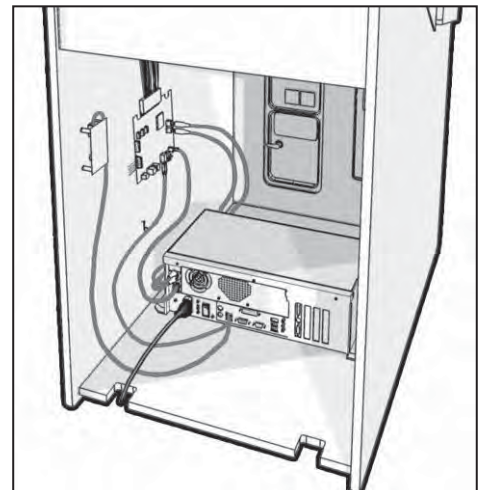

# CONTROL PANEL INSTALLATION

## INSTALL OPTIONAL CONTROL PANEL FOR EXISTING IT CABINETS

If you are installing your kit into an existing Golden Tee Fore! cabinet manufactured by IT, you can purchase a new, fully outfitted control panel. This will not only make your installation easier, it will make your game look and play better too. Use this section to install this control panel. For all other cabinet types, refer to the next section.

Attach the new control panel to the existing hinge on the control panel drawer. Drive the 4 Phillips screws into the holes in the bottom of the control panel. The control panel comes equipped with trackball and buttons in place. Snap the switches onto the buttons. The following buttons need to be connected: Left, Right, Fly-By, Help, Options, Spin and Start/Replay. Connect to the normally open post. Be sure common ground is connected to each common post.

Help and Options are new buttons and come with the cable installed to the buttons on the new control panel. Connect the 8-pin connector to the Lamps connector J202 on the I/O Board. Connect the 10-pin connector to the Control Panel connector J203 on the I/O Board. Finally, connect the Trackball to the trackball connector J208 on the I/O Board.

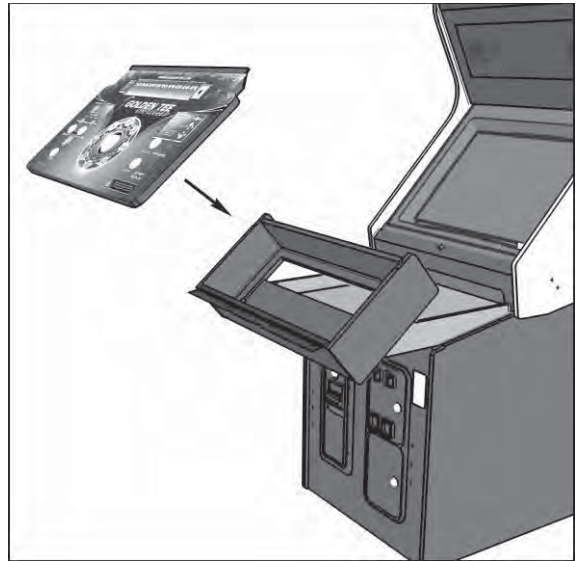



## TRACKBALL AND BUTTON PREPARATION (FOR MOST KITS)

Mounting the trackball and buttons correctly and securely is very important for the profitability and safety of your new game. This kit is designed for use in cabinets with  $\frac{3}{4}$ " thick wood control panels where proper routing of the control panel is used to create a safe playing experience. If you do not have a  $\frac{3}{4}$ " thick wood control panel, please replace your control panel or choose a cabinet with a  $\frac{3}{4}$ " thick wood control panel installed. Keep in mind that if your current control panel has many old holes in it from previous buttons, joysticks, etc. that it may be easier to start with a new solid control panel. This will give your game a better look and feel and help it to earn better.

**Note:** If the cabinet already has a trackball plate installed, discard and replace with the new trackball plate. The metal trackball mounting plate and trackball mounting procedure have been designed to remove all bolts from the playing surface. Routing the wood control panel is required so the metal mounting plate is flush with the panel surface. An uneven playing surface or exposed edges will affect game play and could impact your earnings.

**TIP:** Trackball and button templates can be found in Appendix G of this manual. They include:

- Trackball Orientation Diagram to orient your trackball correctly when installing.
- Trackball Mounting Template to install the trackball plate and make the appropriate routing.
- Button Set Templates to position and install control panel buttons.

### Trackball Preparation

Install the metal trackball plate by following these steps:

1. Cut out the template from Appendix G with a pair of scissors along the noted line. Tape this template to the top of the control panel as far away from the monitor as possible, making sure that the trackball will clear the cabinet beneath it.  
**Note:** Installing the trackball as far away from the monitor as possible will prevent players' hands from hitting the monitor glass when rolling the trackball forward.
2. Using a sharp object, mark the eight points shown on the template on the control panel. Using a pencil, trace the outside of the template. Remove the template.
3. Drill Holes 1-4 with a  $\frac{9}{32}$ " or  $\frac{5}{16}$ " drill bit.
4. Drill Holes 5-8 with a  $\frac{3}{4}$ " drill bit.
5. Route the crosshatched region to a depth of about .075" (about the thickness of a nickel).
6. Using a sabre saw cut out the center portion by cutting between holes 5-8.
7. Once you have cleaned up the routed area, install the trackball plate into the control panel using the  $\frac{1}{4}$ " Flat Washers and  $\frac{1}{4}$ -20 Nylon Hex Nuts. Be sure the mounting plate is flush with the top of the control panel.

**Note:** At this time you are only installing the trackball plate. Do **NOT** install the trackball or buttons until the control panel graphics have been applied.

### Button Preparation

The following are the steps you should take to prepare your control panel for the installation of the button assemblies:

1. Cut out the template(s) (see Appendix G).
2. Using a tape measure, measure the specified distances from the center of the trackball hole in the trackball plate and make a mark the reference points indicated on the left and right button set templates (see Appendix G).
3. Lay each template over the appropriate reference marking point. Mark the centers of the remaining holes using a sharp object.
4. Drill a 1  $\frac{1}{8}$ " hole at each marked point.

Once the installation is complete, be sure to use the System Controls test in the game's System Setup menus to ensure proper functionality of all the player controls.

## CONTROL PANEL OVERLAY INSTALLATION

Golden Tee GOLF comes with an oversized control panel overlay that will accommodate a variety of existing game cabinets, but works best on Golden Tee Fore!, NFL® Blitz™ and EA Sports™ PGA Tour® Golf cabinets. Follow these instructions to correctly install the control panel overlay on one of these cabinets:

1. Make sure that the newly drilled control panel has a smooth, clean surface. Sand where necessary to make sure the graphics are installed on an even surface.
2. Clean the control panel to make sure it is free from dust, grease, metal filings, etc. Make sure that all residues (adhesive, overlay material, etc.) from the previous control panel graphics are removed. This will ensure a clean, easy, and beautiful application of the control panel graphics.
3. **It is very important that the trackball and control panel graphics be mounted perfectly straight.** Find the center of your trackball template and lightly draw vertical and horizontal guidelines on the control panel, marking out your centering lines.
4. Remove a small section of the protective backing from the overlay. Carefully center the overlay over the control panel by lining up the die-cut hole with the trackball template. **Be sure the graphic is positioned perfectly straight.** Line up your pencil guidelines with the lines incorporated into the art. Once in position, gently press down on the section with exposed adhesive, affixing the overlay into place. Once affixed, the overlay cannot be removed.
5. While holding down the overlay over the attached area, very carefully turn over one side and remove the exposed backing. Gently lay down the exposed overlay from the center outward, smoothing with your hands or a roller as you go. **Be sure the overlay remains straight and square.** Repeat the process with the other side of the overlay, so the entire surface is affixed to the control panel. Make sure all bubbles have been pressed out for a clean, flat surface.  
**TIP:** Liquid window cleaner can be sprayed onto the control panel before placing the overlay onto the control panel. The window cleaner will allow the overlay to be positioned with less risk of damage to the overlay or adhesive. Once in position, use a decal roller or squeegee to force any excess cleaner out. Be sure to add additional time for the liquid to evaporate.
6. Using a razor knife (or other sharp instrument) carefully cut around the edges of your control panel, trimming any excess material.
7. Find the center of each hole you have drilled out for the buttons and use the knife to poke a hole into the overlay. Make a vertical and horizontal line (like a plus sign) from the center of the hole to the edges. You should be able to place your button in later with no edges showing.

**CAUTION:** If you choose to install a Plexiglas® cover over your control panel (not recommended), to ensure the safety of your players and the quality of your game make sure that all surfaces, edges and bolts that a player may come in contact with are smooth, safe and secure.

## FINISHING THE CONTROL PANEL

1. Reattach the control panel to your cabinet adjusting any hinges or chains where necessary. Make sure not to pinch or crimp any wires while re-attaching the control panel.
2. Install the trackball into the trackball plate. The trackball must be oriented correctly in order to function properly. Refer to the diagram located in Appendix G for correct orientation. You will need the following parts in order to install the trackball correctly to the plate: 4 - 10/32 x 2½" Phillips Head Machine Screws, 4 - #10 Flat Washers and 4 - #10 Split Lock Washers **NOTE:** Do not over-tighten the trackball. It will warp and cause the trackball to not operate correctly.

**IMPORTANT!** Be sure to install your trackball securely, and maintain it regularly. Loose, worn, or incorrectly mounted trackballs can result in decreased earnings and possible injury to players.

3. Secure the trackball ground wire to the trackball plate at the 8-32 stud on one end with an 8-32 KEPS nut and the other end to the cabinet ground stud (usually located near the AC power cord inlet) using an 8-32 KEPS nut.
4. Install the buttons in the holes located on your control panel. Make sure you use the red button assembly for the Start button.
5. Attach the micro switches to your newly installed buttons and connect the wires up to the correct pins on the JAMMA harness.



**Note:** The post on the switch labeled COM should connect to the ground wire and the post labeled NO should connect to the signal wire. See the pin out chart in Appendix B.

**WARNING:** Trackball and trackball plate **MUST BE GROUNDED** to Earth Ground to prevent damage to the trackball, game electronics or harm to operators.

# COMPLETE SYSTEM BOX CONNECTIONS

Follow these procedures to correctly connect the various electronic components. Be sure the cables are connected securely and in working order. Use cable clamps, with appropriate tension, where necessary to ensure all cables stay in place during operation. Dress all cables with additional clamps and wire tie wraps where needed. Avoid loose wires or disconnected cables, as they can cause an unneeded service call.

## ATTACH I/O POWER, AUDIO AND USB CABLES

- ◆ **I/O board power cable.** Connect from the I/O board to one of the two 4-pin power output connectors on the system box.
- ◆ **Audio cables.** Connect to the audio output jacks of the system box. Match the appropriate colors.
- ◆ **USB cable #1.** Connect from the I/O board to any USB port on the system box.
- ◆ **USB cable #2** for future updates. Attach to any USB port on the system box. Route the other end to the control panel for easy access when updating.
- ◆ **USB cable #3** for Cabinet Identification Device (CID). Refer to the CID Installation Section for proper orientation and placement of the CID.

## ATTACH MAIN VIDEO CABLE

If your cabinet has a VGA or SVGA monitor, connect the video cable from the system box directly to the VGA or SVGA monitor input.

If your cabinet has Medium or Low Resolution monitor, connect the video cable from the system box to the I/O board.

If your monitor is a high-definition television, connect the appropriate video cable from the system box to the television inputs. Refer to Appendix D for help with the available connection configurations.

Be sure to adjust your Dip Switch settings to match your monitor's resolution. Refer to Appendix D.

## ATTACH POWER CABLE

Use the AC power cord that is currently in your cabinet. The cord plugs into the System box. Have a qualified electrician do the wiring. Verify A.C. main voltage selector switch is in the proper position. In North America the setting is 115 volts AC. In some countries this should be set at 230 VAC.

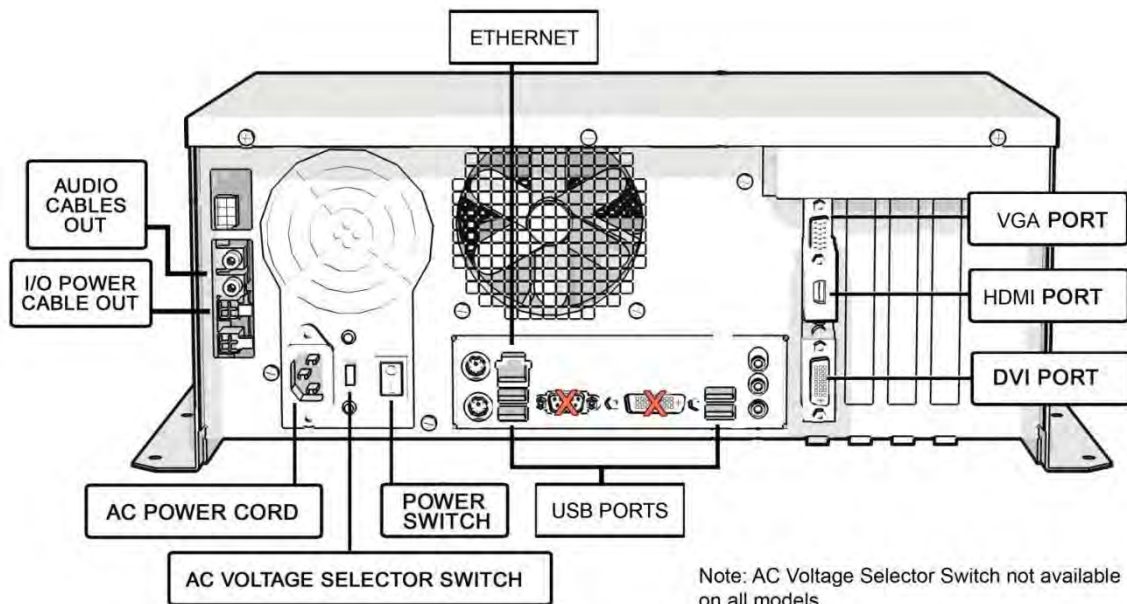

# **COMPLETE I/O BOARD CONNECTIONS**

## **CONNECT JAMMA HARNESS**

Connect the JAMMA Connector to the I/O Board. Be sure it fits tightly and is oriented correctly.

## **CONNECT THE CONTROL PANEL SWITCHES AND CABLE**

Snap the switches onto the buttons. Connect the Control Panel wiring harness using the JAMMA wiring chart found in Appendix B - Kit.

## **CONNECT COIN DOOR LAMPS**

Connect the coin door lamp cable to the pigtail off the I/O Power cable. If your cabinet originally had a Golden Tee Fore! green PCB, then use the 9-pin connector. If your cabinet had a Golden Tee Fore! red PCB, then use the 4 pin connector. Find the mating connector leading to the coin door to make your connection.

## **CONNECT THE TRACKBALL**

Locate the Trackball Cable and connect it to the connector labeled Trackball on the I/O board. The other end will connect to the trackball. Connect the green earth ground wire to the trackball plate.

## **CONNECT AUDIO CABLES**

Locate the Audio Cables already connected to the system box, and connect them to the I/O board audio inputs. Inputs are color coded, so be sure to connect red to red, etc.

## **CONNECT THE USB CABLE**

Locate the 6 ft. USB Cable from the system box and connect it to the USB port on the I/O board.

## **CONNECT MEDIUM OR LOW RESOLUTION CRT MONITOR**

If your cabinet has a Medium or Low Resolution monitor, you need to connect the video to the I/O board. Connect the SVGA Video cable from system box to the J501 connector on the I/O Board. Connect the Red, Green, Blue video outputs, the composite sync, and video ground from the JAMMA connector to the appropriate monitor inputs. To find the correct JAMMA pin outs refer to the diagram in Appendix B. Be sure to set the Video Dip Switches on the I/O Board (Sw201) to match your resolution. Refer to the diagram in Appendix D.

## **CONNECT VGA OR SVGA CRT MONITOR**

VGA or SVGA monitors are connected directly to the system box video output. Do not connect a video cable to the I/O Board if you are using these resolutions.

## **CONNECT HIGH-DEFINITION TELEVISION**

In addition to traditional CRT monitors, GOLF also supports 800x600 and 1280x720 (SVGA, DVI-D and Component) resolutions for some high-definition televisions. These televisions can be connected to the system box using Component, S-Video, DVI to VGA and DVI to HDMI connections. Refer to the diagrams in Appendix D for the proper connection for your television. Be sure to set the Video Dip Switches on the I/O Board (Sw201) to match your HDTV resolution.

## **CONNECT I/O POWER CABLE**

Connect the I/O Power cable to the power input connector. Use the end with the pigtail. The other end connects to the system box.

## **CHECK ALL CONNECTIONS**

Go over your entire cabinet again and double-check all of the connections. Make sure that all connectors are tight and secure and in their proper place. Look for frayed, broken or exposed wiring and repair as needed. Bundle and wire-tie your wiring and secure it to the inside of the cabinet. A thorough and neat job now will save you a lot of time and trouble in the future.

## CABINET GRAPHICS INSTALLATION

Included with your Golden Tee GOLF kit is a set of decals to place on the side of your cabinet and a brand new marquee. This will help identify your new game as Golden Tee GOLF. By placing and installing these correctly it can help give players instant recognition, even from a distance.

## MARQUEE INSTALLATION

The following are the instructions for placing the new marquee in your cabinet:

1. Using the old marquee glass as a template, center the glass on top of your new marquee. Make sure that all the printed images are visible.
2. Using an X-acto® knife or other sharp blade, score the new marquee deeply by following the edges of the old glass as a guide.

**CAUTION:** Do not cut on table or counter top. Use a cutting board or a disposable surface.

3. Carefully break off any excess material you have cut off.
4. Be sure the light behind the marquee works.
5. Clean the glass on both sides to give players a clear view of the new marquee.
6. Install the marquee graphics and glass securely.



# FINAL CONNECTIONS

## COIN DOORS, TEST SWITCH, AND VOLUME CONTROLS

Wire the coin doors as per the JAMMA Harness Connection table in Appendix B - Kit. Connect the door lamps to the appropriate (+12Vdc or +5Vdc) supply. Some games have separate power supply outputs for the lamps. Install a test switch somewhere convenient inside the coin door area. This switch allows you to enter adjustables, run diagnostics, and see or clear audits. Make it readily accessible through the coin door. Wire it to the Test wire on the JAMMA Harness. GOLF has the ability to adjust volume at any time during a game. Install two push button switches (not included) inside the coin door for easy access. Connect the switches to the JAMMA harness. Refer to the JAMMA Harness Connection table in Appendix B - Kit.

## INITIAL POWER-UP

There are several steps you should take when powering up your Golden Tee GOLF for the first time. This is a quick checklist for you to follow when doing your first initial power-up:

- Plug in the game and turn it ON; be sure the game powers up correctly into the attract mode.
- Adjust volume levels to desired settings.
- Adjust monitor settings for best picture.  
**NOTE:** Sound and Video Tests are available through the System Tests Menu. They are beneficial when making any adjustments. Proper monitor and sound adjustment is very important.
- Try all money slots. Drop quarters or tokens through to check the coin mechanisms and insert a bill into the bill acceptor. Make sure the game is adding credits.  
**NOTE:** GOLF supports most bill acceptors. Installing a bill acceptor is highly recommended and will increase your earnings. Refer to your bill acceptor's manual for installation specifications. The bill acceptor can be wired to coin door 3 on the JAMMA.
- Test all of the player input controls. You can use the PLAYER CONTROL TESTS in the SYSTEM SETUP MENU.
- Upon initial power-up the game is set to factory default settings. These settings affect game elements such as number of credits per coin, volume settings, etc. The SYSTEM SETUP MENUS section will describe how to alter these settings for your location.

**Congratulations! You have finished installing  
Golden Tee GOLF!**

# SYSTEM SETUP MENUS

---

## NAVIGATING THE MENU SYSTEM

The System Setup menus cover a variety of important areas including collections, tests, game adjustments, and optional settings. You should familiarize yourself with these menus, as they are designed to optimize your game for your location and your business. Pay particular attention to the Collection menus, as they will detail how much money to give to your location and help you maximize your investment.

## ENTERING SYSTEM SETUP MODE

There are two ways to enter System Setup. Open the coin door and press the Test button to access the game's System Setup software menu system. Or, from the I/O Board, move the DIP switch SW202 position 4 to the ON position. This switch needs to be moved back to OFF to exit the System Setup menus. Refer to the diagram in Appendix D for all DIP switch settings.

## SELECTING A MENU

A menu option can be selected at any time by rolling the trackball up or down or by pressing the Left or Right buttons.

## CHOOSING A MENU/OPTION

A menu option can be chosen at any time by pressing the Start Button.

## CHANGING A VALUE

A value can be changed at any time by rolling the trackball left or right.

## MAIN MENU

The Main Menu displays five main areas that make up System Setup mode. Please familiarize yourself with these areas, as they will help you maximize your earnings potential.

### Collections & Earnings – See Page 29

This section displays your machine's monetary activity, and details the various areas for income and expenses. This section should be reviewed during every collection, to make sure you manage your split correctly.

### General Settings – See Page 30

This area allows you to change operator adjustables, perform system tests, and reset your game back to factory settings.

### Troubleshooting Shortcuts – See Page 41

This section presents a variety of tests and menus that will help you troubleshoot any problems you may be having with your game. The available sections are also accessible through the other main sections.

### Golden Tee Settings & Audits – See Page 41

This area allows you to adjust settings specific to Golden Tee GOLF including the player cost schedule, game features, and game audits.

### ITNet Settings (Not available on GT GOLF)

Golden Tee GOLF is an offline product. The ITNet menu is not available.

### Exit

This will exit the System Setup menus and take you back into the game's attract mode.





## COLLECTIONS & EARNINGS MENU

This menu allows you to perform a collection or view various earnings and fees.

### Do Collection

This section is used when making a collection. The various screens will detail the cost breakdowns and show you how much of the cash box is to be paid to the location. Please take some time to familiarize yourself with this section. Using it wisely can save you money.

### Clear Unused Cash

Sometimes when you go to make your collection, there is money in the game that has not been played yet. Use this setting to clear the unused cash from the screen, so your future collections will reconcile with game play.

### Add Free Cash

Use this setting if you wish to add money to the game for free plays that do not advance the hard meter.

### Back

This will take you back to the **Main Menu**.



## DO COLLECTION

This screen is the main collection screen. There is a lot of helpful information displayed that will help you with your collection. It is highly recommended that you view this screen with every collection, and reset it when your collection is complete.

This screen displays the following helpful information:

### Collection Date Range

The displayed dates are from your last collection until today.

### Days In Operation

The number of days the machine was active and available for play since the last collection.

### Reset

Highlight this to reset the number of days in operation field.

### Total Income

The total income your machine made for this time period.

### More Details

This brings up a second menu that further details income amounts.

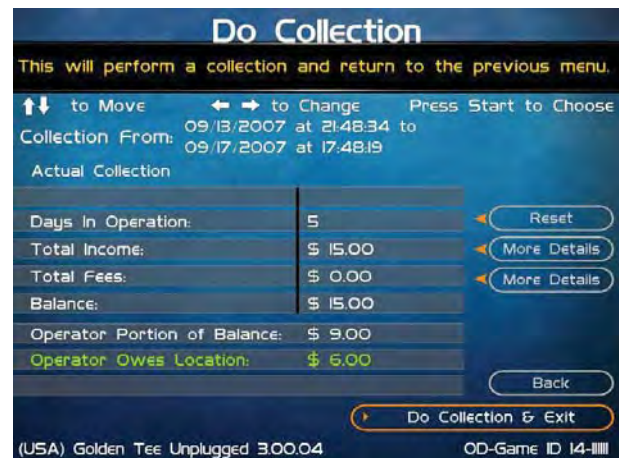

## Total Fees

The total of the various fees that need to be set aside before making your split.

## More Details

Select this to display a breakdown of the various fees, including Hardware Upgrade fees and tax splits.

**Note:** Hardware Upgrade Fees are included for your convenience, to help you cover the costs of owning and operating your equipment.

## Balance

The total income minus the total fees.

## Operator Portion of Balance

The amount of the collection that the operator keeps.

## Operator Owes Location

The amount of the collection that you pay your location.

## Back

If you do NOT wish to perform a collection and reset the audits, highlight Back to exit this screen and return to the **Collections & Earnings** menu.

## Do Collection and Exit

If you wish to perform a collection and reset the audits (recommended), highlight Do Collection and Exit and press Start. This will set all the fields in the Do Collection screen to zero. Be sure to empty your cash box at the same time, so these screens will match the money at your next collection.

## GENERAL SETTINGS

The General Settings menu houses various adjustable settings relating to the cabinet, and is divided into three sections.

### Operator Adjustables

This area allows you to adjust options like volume, attract mode sounds, collection settings and money slot settings.

### System Tests

This area allows you to perform diagnostics including video adjustments, input tests, and sound tests.

### Back

This will take you back to the **Main Menu**.

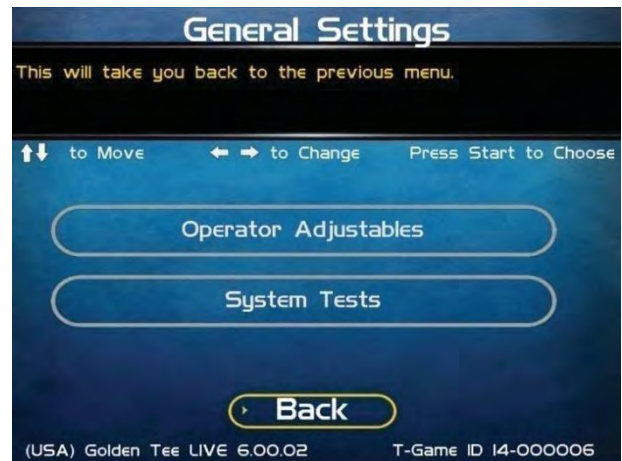

## OPERATOR ADJUSTABLES

This menu contains adjustable settings that pertain to you and your business. Please familiarize yourself with this section, as it can help you maximize the game's earning potential.

### General Adjustments

This area allows you to adjust options like coin message and money modes.

### Money Slot Adjustments

This area allows you to adjust the settings of your various money slots on your cabinet.

### Sound Adjustments

This area allows you to adjust the various sound settings including attract mode sounds, game volume, and stereo setup.

### Collection Settings

This important area allows you to adjust various fees and splits for your collections.

### Reset To Factory Settings

This option allows you to reset all the settings found in the Operator Adjustables section to factory defaults.

### Back

This will take you back to the **General Settings** menu.

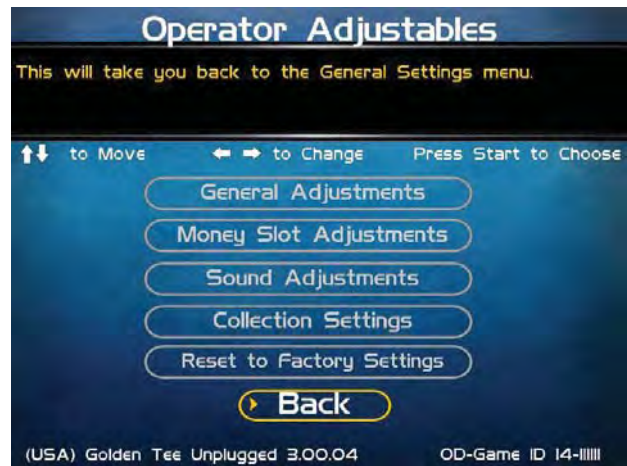

## GENERAL ADJUSTMENTS

### Coin Message

The default is set to Insert \$.

### Accept Credit Card (Not available)

This selection is not available on Golden Tee GOLF.

### Game Mode

This lets you toggle between money/free play. **The default is set to Money Play.**

### 2<sup>nd</sup> Monitor Mode

You can add an external monitor to your dedicated or kit game by connecting it to the appropriate video output on the Nighthawk Chassis. Use this setting to select from SVGA and S-Video signals.

### 2<sup>nd</sup> Monitor Output

A second monitor can be added to clone the main monitor output.

### Advertisements

This option allows you to "Show All Ads" or turn ads off.

### Back

This will take you back to the **Operator Adjustables** menu.

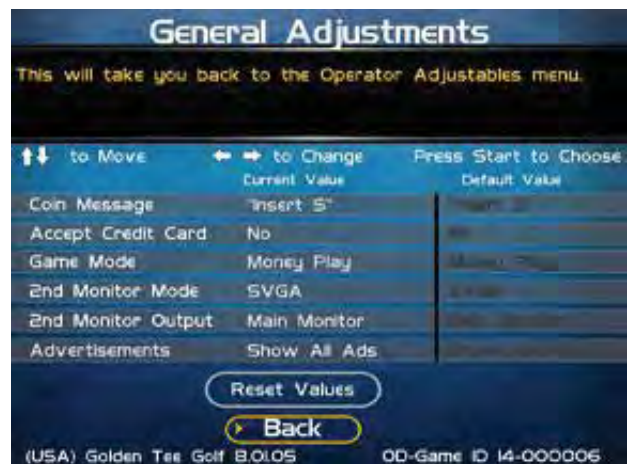

## MONEY SLOT ADJUSTMENTS

### Money Slot 1 (all machines)

This adjusts how much one pulse equals for Money Slot 1. **The default is set to \$0.25.**

### Money Slot 2 (kits only)

This adjusts how much one pulse equals for Money Slot 2. **The default is set to \$0.25.**

### Money Slot 3

This adjusts how much one pulse equals for Money Slot 3. **The default is set to \$0.25.**

### Credit Card (Not available)

This selection is not available on Golden Tee GOLF.

### Reset Values

This resets all values to their default value located on this page.

### No

This will not perform the reset and take you back to the previous menu.

### Yes

This will perform the reset and take you back to the previous menu.

### Back

This will take you back to the Operator Adjustables menu.



## SOUND ADJUSTMENTS

### In Game Volume

This option lets you adjust the In Game volume from OFF to 100%. **The default is set to 30%.**

### Attract Volume

This option lets you adjust the Attract Mode Volume from OFF to 100%. **The default is set to 30%.**

### Attract Mode Sounds

This adjusts how often sounds are played in the attract mode: Never, Rarely, Sometimes, Often, and Always. **The default is set to On - Sometimes.**

### Stereo/Mono

This option is where you select stereo or mono setup. **The default is set to Stereo.**

### Reset Values

This resets all values to their default value located on this page.

### Back

This will take you back to the **Operator Adjustables** menu.



## COLLECTION SETTINGS

Golden Tee GOLF allows you to adjust costs and percentages for the various income types that are received. Use this menu to determine how much you want your location to help you pay for these charges and services.

### Set Hardware Update Fee

This menu allows you to adjust the Hardware Update Fee. This fee is included for your convenience, as a method to have the location pay for part of your equipment. The default value for 2013 machines is \$0.00 per week. Adjust this value to an appropriate amount for your location.

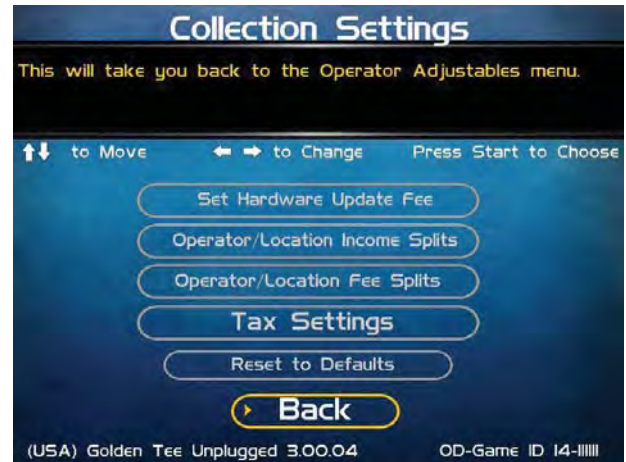

**Note:** Hardware Update Fees are included for your convenience. No income is sent to IT on Golden Tee GOLF.

### Operator/Location Income Splits

Use this menu to fine-tune your splits for any generated income. The default settings are displayed on the accompanying screen.

The adjustable settings refer to income generated from:

- Cash
- Player Account (Not available)
- Credit Card (Not available)
- ITNet Money Card (Not available)
- Operator Money Card (Not available)

Golden Tee GOLF takes cash only.



### Operator/Location Fee Splits

Use this menu to determine how you wish to split the various fees with your location. For example, since there is a fee associated with credit card usage, you may want to adjust the split in your favor to help cover the costs of the transaction fees.

- ITNet Fees (Not available)
- Prize Fund Fees (Not available)
- Credit Card Fees (Not available)
- Communication Fees (Not available)
- Software Update Fees (Not available)
- Hardware Update Fees

Golden Tee GOLF is an offline product and has no fees or income from online sources.

Hardware Update Fees are added for your convenience if you wish to have the location help pay for your equipment.



## Tax Settings

Many states require special taxes or license fees that affect your bottom line. Use this menu to separate these costs from your collection before making your normal split.

### Set Tax Rate

This menu allows you to adjust your current tax rate percentage.

### Set Tax Type

This menu helps you determine what part of the collection is taxed, and who pays for these taxes.

### Set Tax Split

This menu allows you to split the tax fees with the location.

### Reset to Defaults

This menu will set all of the collection settings to their factory default values. A verification screen will display to make sure you agree to the change.

### Back

This will take you back to the **Collection Settings** menu.

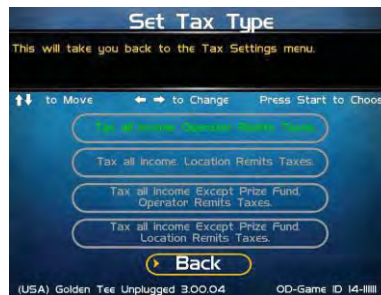

## RESET TO DEFAULTS

This menu will reset ALL settings in the Operator Adjustments section to their default values. A verification screen will display to make sure you agree to the change.

### Please Note:

This process may take several minutes to complete.



## SYSTEM TESTS

This area allows you to perform diagnostics including video adjustments, input tests, and sound tests.

### Video Tests

This area has tests that will help you to adjust your game's color, contrast, and screen size.

### Sound Tests

This area has tests that will help you adjust your game's audio setup by playing a stored sound, a streaming sound, and testing the speaker(s).

### Player Control Tests

This option allows you to test all inputs including trackball, buttons, and money slots.

### Mechanical Meter

This test makes the hard meter adjust by one to make sure it is functioning properly.

### Hardware Tests

This area includes a series of diagnostic screens and tests to help you make sure your game is functioning correctly.

### Back

This will take you back to the **General Settings** menu.



## VIDEO TESTS

The Video Tests section has a variety of tests that will help you adjust your monitor.

### Color Test

This area will take you to a series of tests to adjust your monitor's RGB settings to have each color display properly.

### Contrast Test

This area will take you to a series of tests to adjust your monitor's brightness/contrast so the game displays properly.

### Screen Size Adjustments

Use this screen to align your monitor so that all the circles appear as circles and the boundary line appears on the edge of each side of the screen.

### Back

This will take you back to the **System Tests** menu.



## COLOR TEST

### Color Grid Adjustment

Adjust your monitor to have each colored box display properly.

### Red Screen

Adjust your monitor to have red display properly.

### Green Screen

Adjust your monitor to have green display properly.

### Blue Screen

Adjust your monitor to have blue display properly.

### Back

This will take you back to the **Video Tests** menu.



## CONTRAST TEST

### White Screen

Adjust your monitor to have white display properly.

### 50% White Screen

Adjust your monitor to have 50% white display properly.

### 25% White Screen

Adjust your monitor to have 25% white display properly.

### Black Screen

Adjust your monitor to have black display properly.

### Contrast Screen

This option is a test you can use to adjust your monitor's contrast and brightness settings to have the boxes displayed properly.



**Note:** May not work on older or often used monitors. If you have a monitor that's old or has been used often you may not be able to adjust the contrast and/or brightness levels accordingly. In this case adjust the monitor for best performance while getting close to the recommended settings.

### Contrast Screen

This option is a test you can use to adjust your monitor's contrast and brightness settings to have the boxes displayed properly.

### Back

This will take you back to the **Video Tests** menu.

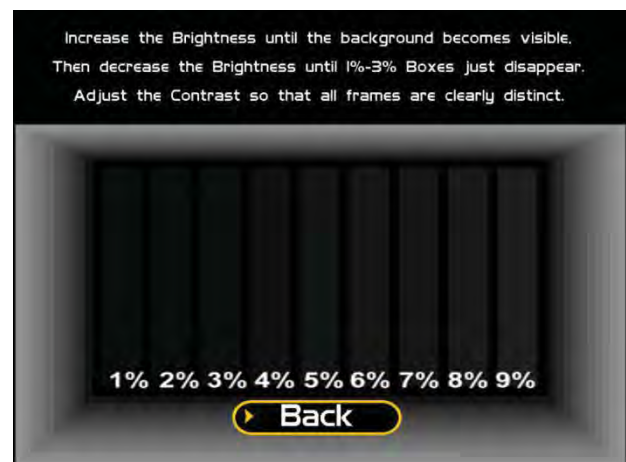



## SCREEN SIZE ADJUSTMENT

Use this screen to adjust the size and aspect ratio of your picture. Press the Start button to exit.

If you are using an HDTV display, you may need to adjust this screen to see the complete image. Use the trackball to highlight BIGGER or SMALLER and press the Start button to adjust the screen image. Press DONE to exit.

**Note:** Adjusting the screen size will prompt a reboot upon exit of this menu.

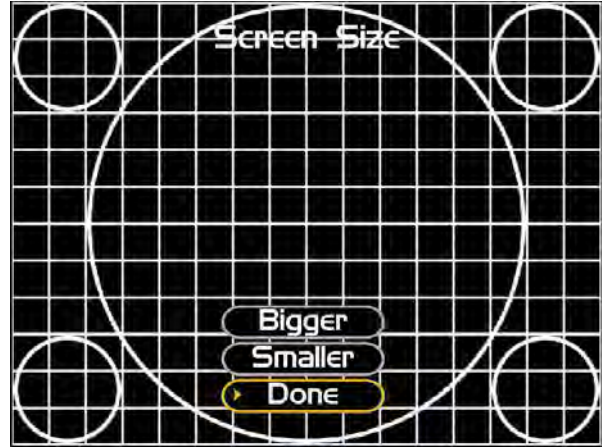

## SOUND TESTS

### Stored Sound

This will play a stored sound so you can make sure your audio setup is functioning properly.

### Streaming Sound

This will play a streaming sound so you can make sure your audio setup is functioning properly.

### Speaker Test

This test will say MONO if you have your game set to Mono or LEFT and RIGHT if you have it set to stereo so you can make sure your audio setup is functioning properly.

### Back

This will take you back to the **System Tests** menu.



## PLAYER CONTROL TESTS

Use this screen to test all of the inputs, including the trackball, buttons, and money slots. When an input is active the appropriate graphic image will light. Press the Left, Right and Start buttons simultaneously to exit this test screen.

When testing the trackball, the Current value will change depending on the direction the ball is spinning. The Max value will display the largest number reached during the test. There is no exact number to determine whether a trackball is malfunctioning, but in general the Max number should be close to the same when spinning up and down, and close to the same when spinning left and right.

When testing coin and bill acceptor switches, the number of pulses read will be displayed below the appropriate image.

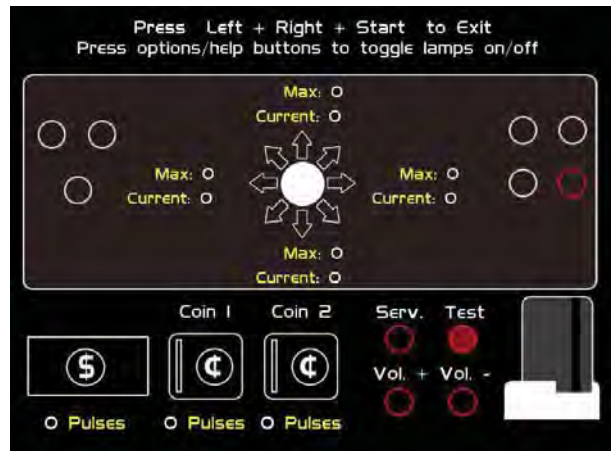

## MECHANICAL METER TEST

### Click Meter

This test makes the hard meter adjust by one to make sure it is functioning properly.

### Back

This will take you back to the **System Tests** menu.



## HARDWARE TESTS

This area includes a series of diagnostic screens and tests to help you make sure your game is functioning correctly.

### Hardware/Software

This area has options to view your system, USB and version info.

### Check Hard Drive

This test checks the integrity of your hard drive's data. **Note:** *This test can take several minutes.*

### Check Cooling

This test helps you make sure your game is functioning at the proper temperature and all fans are working.

### Check Card Reader (Not used on Golf)

This selection is not available on Golden Tee GOLF.

### Back

This will take you back to the **System Tests** menu.



## HARDWARE/SOFTWARE

### System Info

This is a list of your game's current basic system info.

### USB Info

This is a list of your game's current USB devices.

### Version Info

This is a list of your game's software version information.

### Back

This will take you back to the **Hardware Tests** menu.



## SYSTEM INFO

This is a list of your game's current basic system information, including Hard Drive, CPU and Video Card.

### Back

The Back button takes you back to the **Hardware/Software** menu.



## USB INFO

This is a list of your game's current USB devices.

### Back

The Back button takes you back to the **Hardware/Software** menu.



## VERSION INFO

This is a list of your machine's software versioning.

### Back

The Back button takes you back to the **Hardware/Software** menu.



## CHECK HARD DRIVE

### Check File Data

This test checks the integrity of your hard drive's data.

Select **Begin Test** to initiate the process.

**Note: This test can take up to 3 hours to complete.**

If this test succeeds you will see the message: **Status: Hard Drive Functioning Properly.** If this test fails, you will see the message: **Hard Drive Error (#)**

Select **Back** to skip the test and return to the **Check Hard Drive** menu.

### Check File System

This test REBOOTS YOUR GAME and performs a low level systems check of the integrity of your hard drive.

**Note: This can take several minutes.**

### Back

This will take you back to the **Hardware Tests** menu.

## CHECK COOLING

This checks that your game is functioning at the proper temperature and all fans are working. The current status is color-coded for easy viewing. If the results are displayed in green, your cabinet is at normal settings.

### Back

The Back button takes you back to the **Hardware Tests** menu.



## TROUBLESHOOTING SHORTCUTS

This section gathers many of the commonly used tests and menus into one convenient area. Check here first when troubleshooting problems or questions about the integrity of your machine.

The tests that are available in this section are:

- Check Card Reader** (Not available on Golf)
- Check Cooling**
- Check Hard Drive**
- Screen Size Adjustments**
- Communications Settings** (Not available on Golf)
- Player Control Tests**
- System Tests**

Descriptions of each of these tests and sections can be found elsewhere in this manual.

### Back

This will take you back to the **Main Menu**.



## GOLDEN TEE SETTINGS & AUDITS

### Golden Tee Settings

This section allows you to make custom adjustments to certain features on your machine, such as the delay of game timer.

### Golden Tee Audits

This area allows you to view your money audits, game purchase audits, and reset audits.

### Player Cost Schedule

This option allows you to adjust the amount of money it costs a player to play various game types.

### Reset Leaderboards & Records

This area allows you to clear any or all local Leaderboards and high score screens. Note: This process may take several minutes to complete.

### Back

This will take you back to the **Main Menu**.



# GOLDEN TEE SETTINGS

## LIVE Prizes (Not available)

Prize play is not available on offline games.

## Delay of Game Timeout

Adjust the timer that senses activity between shots.

## Closest To The Pin LIVE (Not available)

Live play is not available on offline games.

## Operator CTP

Activate the ability for the game to enter Closest to the Pin (CTP) mode. This version of CTP does not display any sponsored or branded game elements.

## Activate Sponsored CTP (Not available)

Sponsored CTP is not available on offline games.

## Hole-N-Win (Not available)

Hole-N-Win is not available on offline games.

## More

Selecting More brings you to a second page of Golden Tee settings.

## Locked Conditions (Not available)

Locked Conditions are not available on offline games.

## Free Holes in Attract Mode (Not available)

This feature is not available on offline games.

## Difficulty

You can set the difficulty of the courses, to adapt the game to the needs of your specific location. Difficulty settings can be adjusted from 1 (easiest) to 5 (hardest). The default setting is 2.

## Pre-game Casual Clothing (Not available)

Players have a selection of all clothing prior to 2013 available.

## Mulligans

Mulligans allow casual game players to retake a bad shot during their game. To disable this feature select OFF.

## Allow Casual Straight Shots

This allows casual players the option to choose whether to play with only straight shots or to allow curved shots as in standard settings mode. To disable this feature select NO.

## Spotlight Player Settings

These settings allow local operators to offer prizes based on Golden Tee casual golf game play.

## Reset Values

This will reset all Golden Tee Settings to their factory defaults.

## Back

This will take you back to the **Golden Tee Settings & Audits page**.



## CASUAL GOLF SPOTLIGHT PLAYER

This allows operators to set the prize for a weekly drawing based on all players who achieved a score of PAR +17 or better.

### Prize Settings

This opens This Week's Prize Settings to set the prize available for the winner of the drawing.

### Clear Last Winner

This removes the last winner from the results.

### Reset Values

This will reset all Casual Weekly Drawing settings



## SPOTLIGHT PLAYER PRIZE SETTINGS

### Edit Prize Text

Enter the text that best explains the prize offered. For example, "Free dinner any week night to this week's winner!"

### Remove Prize

Select this option if you do not wish to run a prize drawing.



## GOLDEN TEE AUDITS

This section displays various counts and totals for a number of game options. The following values are based on the last reset, the date of which is shown at the top of the screen.

**Total Number of 18 hole purchases**

**Total Number of 9 hole purchases**

**Number of 1 hole purchases**

**Number of skins play purchases**

**Mulligans purchased**

**Coin Slot 1**

**Coin Slot 2**

**Bill Acceptor**

**Lifetime Money In**

This field shows how much total money your machine has made since its initial registration with ITNet. This field is cumulative and is not affected by resetting the audits on this screen.

### Reset Audits

This will reset all audits to zero, and update the date of the last audit reset. The Lifetime Money In field will not be affected by this function.

### More

This will take you to another **Golden Tee Audits** page.

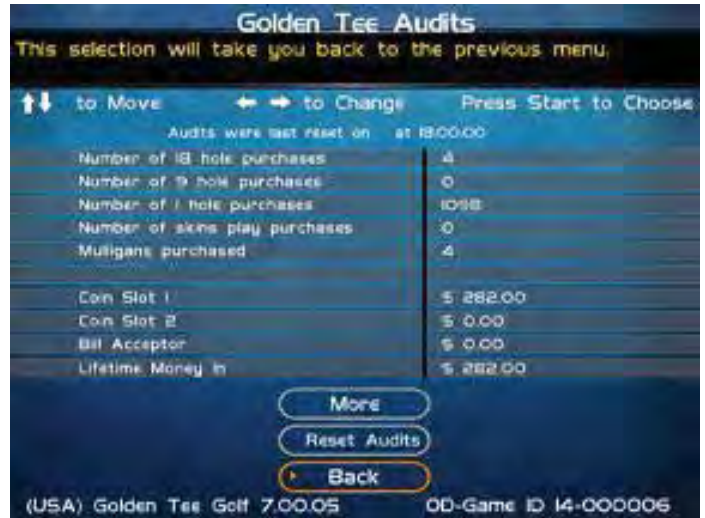

## GOLDEN TEE AUDITS

This second page focuses on casual play feature audits.

**Casual curve shots chosen**

**Casual straight shots chosen**

**Casual spotlight players eligible**

**Casual spotlight players accepted**

**Casual spotlight players declined**

### Back

This will take you back to the previous **Golden Tee Audits** page.

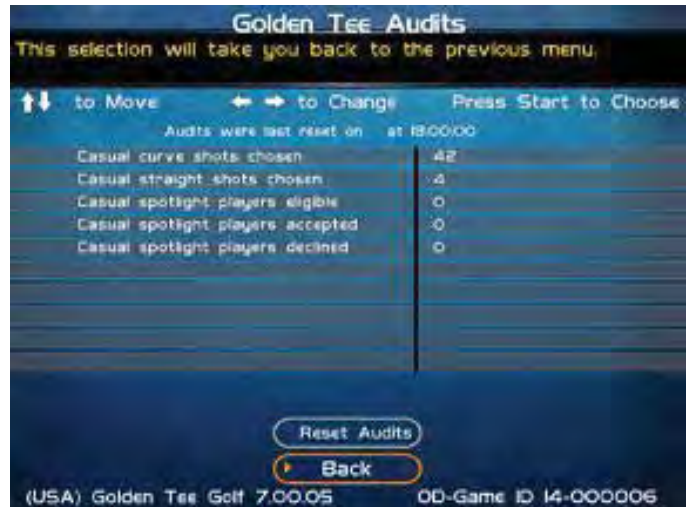



## PLAYER COST SCHEDULE

This screen details the costs of various play selections. The player cost is shown as a total, with the Operator Portion and the ITNet Portion broken out.

### Play Golf (18 Holes)

This option lets you adjust how much it costs a player to play an 18-hole game. **The default is set to \$3.00.**

### Play Golf (9 Holes)

This option lets you adjust how much it costs a player to play a 9-hole game. **The default is set to \$2.00.**

### Play Golf (1 Hole)

This option lets you adjust how much it costs a player to play a single hole of Golf. **The default is set to \$0.25.**

### Mulligans

This option lets you adjust how much it costs a player buy a Mulligan and repeat his shot in Casual Play mode. **The USA default is set to \$0.25.**

### Skins (3 Holes)

This option lets you adjust how much it costs a player to play 3 holes in Skins Play mode. **The default is set to \$0.75.**

### Skins (9 Holes)

This option lets you adjust how much it costs a player to play 9 holes in Skins Play mode. **The default is set to \$2.00.**

### Skins (18 Holes)

This option lets you adjust how much it costs a player to play 18 holes in Skins Play mode. **The default is set to \$3.00.**

### View Fixed Costs

This menu is not available on Golf.

### Reset Values

This resets all values to their default value located on this page.

### Back

Select this to return to the **Golden Tee Settings & Audits** menu.

## RESET LEADERBOARDS & RECORDS

Use this menu to reset various machine-specific Leaderboards.

### Reset Leaderboards

This leaderboard is displayed after every hole during a game. Use this setting to clear the current play data.

### Reset Course Records

Course records, such as best score on each course, are displayed on various screens during a game and in the attract mode, and replayed in the game's attract mode. Use this setting to clear all course records and game highlights.

### Reset All

Use this setting to clear all Leaderboards, course records and game highlights.

Adjustable Costs	Operator Portion	ITNET Portion	Total To Player	Default Value
Play Golf (18 Holes)	\$ 3.00	\$ 0.00	\$ 3.00	\$ 3.00
Play Golf (9 Holes)	\$ 2.00	\$ 0.00	\$ 2.00	\$ 2.00
Play Golf (1 hole)	\$ 0.25	\$ 0.00	\$ 0.25	\$ 0.25
Mulligans	\$ 0.25	\$ 0.00	\$ 0.25	\$ 0.25
Skins (3 Holes)	\$ 1.50	\$ 0.00	\$ 1.50	\$ 0.75
Skins (9 Holes)	\$ 2.00	\$ 0.00	\$ 2.00	\$ 2.00
Skins (18 Holes)	\$ 3.00	\$ 0.00	\$ 3.00	\$ 3.00



## APPENDIX A

### TROUBLESHOOTING GUIDE

<b>Video Problems</b>		
<b>Symptom</b>	<b>Probable Cause</b>	<b>Solution</b>
No picture on the 27" Monitor	I/O Board DIP Switch settings are wrong.	Adjust DIP Switch settings to match the resolution of the monitor you are using. Refer to I/O DIP Switch Settings in Appendix D.
	Incorrect video connection configuration.	Be sure the video connections are correct according to the type of monitor you are using. Refer to the diagrams in Appendix D.
	Monitor does not have a proper A.C. voltage input.	Verify A.C. power to the Nighthawk System box. Verify monitor is working on a known good system.
	Monitor is defective.	Repair or replace.
	Nighthawk System box is defective	Go to Nighthawk System box troubleshooting section.
No picture but game sounds are heard	Incorrect video connection configuration.	Verify video is connected to the system correctly. Refer to the diagrams in Appendix D.
	Since you hear game sounds the system is working.	Review no picture troubleshooting section above.
Scrambled Picture	I/O Board DIP Switch settings are set wrong.	Adjust DIP Switch settings to match the resolution of the monitor you are using. Refer to DIP Switch Settings in Appendix D.
	Incorrect video connection configuration.	Be sure the video connections are correct according to the type of monitor you are using. Refer to the diagrams in Appendix D.
Entire picture is not seen on the screen or it does not fill the entire screen	Misadjusted monitor.	Adjust the monitor width and height. Use video screen adjustment in system tests. Refer to the monitor manual.
Missing or washed out colors	Bad Video connections	Verify continuity from the monitor to the video out on the I/O Board. Red, Green, Blue video signal. <i>Mid. and Low resolution monitors only.</i>
	Contrast and brightness on the monitor needs to be adjusted.	Refer to the monitor manual to make adjustments.
	Defective Monitor.	Verify by connecting a known good monitor to the system.

<b>Sound Problems</b>		
<b>Symptom</b>	<b>Probable Cause</b>	<b>Solution</b>
No audio	Audio Cable between the I/O Board and the Nighthawk system box are not connected.	Verify audio cables are connected. Refer to Appendix D.
	Speakers are not connected properly.	Verify continuity from the I/O Board speaker output pins to the speakers. Refer to Appendix D.
	Volume is set to the lowest level.	Adjust the volume to an audible level.
	Attract mode sounds may be set to all off. You will have sounds when playing the game.	Choose one of the 5 Attract Mode sound options in Sound Adjustments.
	Defective I/O Board.	Verify on a known working system. Replace if necessary.
	Defective Nighthawk system box.	Be certain all other possibilities are explored before replacing the Nighthawk system box.
	DIP switch settings are incorrect for your application	Refer to Monitor Applications at the back of this manual for proper setup.
Distorted or scratchy game audio	Bad speaker.	Replace blown speaker.
	Loose speaker or grill cover is causing vibration.	Verify all components are installed properly and securely.
	Loose/defective audio cables from the Nighthawk system box to the I/O Board.	Check the audio cable connections. Replace cable.
	Defective I/O Board.	Verify on a known working system. Replace if necessary.
	Defective Nighthawk system box.	Be certain all other possibilities are explored before replacing the Nighthawk system box.

<b>Nighthawk Chassis Problems</b>		
<b>Symptom</b>	<b>Probable Cause</b>	<b>Solution</b>
No video and no green lights on the I/O Board. Fans are not heard on the Nighthawk Chassis.	No AC power to the Nighthawk Chassis.	Verify A.C. voltage is connected to the Nighthawk Chassis.
	Power switch on the Nighthawk Chassis is off.	Flip the Nighthawk Chassis power switch to on.
	Main cabinet power switch is off.	Be certain the main cabinet switch is set to on.
	Soft Power Shutdown	Press the Soft Power button with the power turned on. Or, short the top 2 pins of the 6-pin connector on the system box. See Appendix D.
	Defective Nighthawk Chassis.	Be certain all other possibilities are explored before replacing the Nighthawk Chassis.
No video and no green lights on the I/O Board. Fans are heard on the Nighthawk Chassis.	DC power cord not connected from Nighthawk Chassis to I/O Board.	Connect the DC power cord from the Nighthawk Chassis to the I/O Board.
	Defective I/O Board.	Try it on a known good system. Verify by disconnecting all cables from the I/O Board except the DC power and USB cable to the Nighthawk Chassis. No green lights, replace the I/O Board.

<b>Control Problems</b>		
<b>Symptom</b>	<b>Probable Cause</b>	<b>Solution</b>
Button does not work.	Switches Common post is not connected to digital ground.	Verify continuity to digital/power supply ground.
	Signal wire is not connected to the Normally Open post of the switch.	Verify continuity from the I/O Board to the Normally Open post of the switch.
	Switch is defective.	Replace defective switch.
Button always indicates closed in the player control test. Pressing it will show it is not depressed.	Signal wire is connected to the Normally Closed post of the switch.	Connect signal wire to the Normally Open post of the switch.
Button always indicates closed in player control test even with the switch disconnected entirely.	Defective I/O Board.	Test on a known good system. Replace if necessary.
Trackball is not functioning in any direction.	Trackball is not connected to the I/O Board properly.	Verify the trackball is connected to J208 labeled trackball on the I/O Board.
	Defective trackball Interconnect cable.	Verify continuity on the trackball Interconnect cable.
	Trackball is defective.	Replace trackball.
	I/O Board is defective	Replace I/O Board. Try it on a known good system.
Trackball does not work in a certain direction.	Trackball cable is defective.	Verify continuity on the trackball cable. Repair or replace if needed.
	Trackball is defective.	Repair or replace the trackball. Try it on a known working system.
	I/O Board is defective.	Repair or replace the I/O Board. Try it on a known working system.
Trackball works intermittently.	Inside of the trackball is dirty.	Clean the inside of the trackball.
	Rollers are worn.	Replace the rollers and bearings.
	Trackball is over-tightened.	Do not over-tighten the trackball. Tighten just enough to flatten the lock washers.

<b>HDTV Video Problems</b>		
<b>Symptom</b>	<b>Probable Cause</b>	<b>Solution</b>
There is no picture during boot up.	Incorrect video cable configuration.	Be sure you are using the proper cable connections. Refer to the HDTV connections configurations.
	Connected to the wrong output on the system box	Refer to the HDTV connections configurations.
	Connected to the wrong input on the HDTV	HDTVs usually have more than 1 input for a certain input type. Examples are Component 1 & 2; HDMI 1 & 2.
	Incorrect input selected on the HDTV	Be sure the correct input is selected from the HDTV input menu. Example: If using HDMI 1 that input must be selected from the HDTV video input menu.
	DIP switch setting SW 201 on the I/O Board set incorrectly.	Sw201 on the I/O Board must be configured to match the method of video you are using.

<b>Symptom</b>	<b>Probable Cause</b>	<b>Solution</b>
No picture after boot up	Normal black screen is displayed for a period of time just before 3D graphics are displayed.	This is normal operation. Be sure to wait at least two minutes after LOADING GAME is displayed to see if video appears.
	Your VGA cable is connected to the second monitor output.	Connect the VGA connector to the main output port.
	Incompatible video mode	Many monitors will not accept SVGA 720p or 800 X 600. 640 x 480 usually works. A commercial grade HDTV will usually work.
Distorted or fuzzy picture	Improper cable connection	Be sure the video cables are securely connected at the computer video card and at the HDTV. This is especially critical if using a component video cable.
Picture is too big for the screen or does not fill the entire screen.	Incorrect DIP switch configuration.	Be sure Sw201 is configured to match the desired video.
	Increase or decrease screen size in games adjustments.	Location is in General Settings>Operator>System Tests>Video Screen Settings>Screen Size Adjust

### HDTV Audio Problems

No Audio	RCA audio cable is not connected to the system box or HDTV	Connect the RCA audio cable to the system box and then to the proper input on the HDTV.
	RCA audio cable is connected to the wrong audio input of the HDTV	You must connect the audio cable to the matching video input selected. For example: If you are using Component 1 the audio must go to Component 1.
	HDTV audio is muted	Turn the mute off in the HDTV menu.
	Volume is turned down on the monitor or game sounds are set too low.	Adjust the volume on the game to 75% and then adjust the game volume to your desired level.
Low volume	Volume is turned down on the monitor or game sounds are set too low.	Adjust the volume on the game to 75% and then adjust the game volume to your desired level.
Scratchy or distorted audio	Poor cable connection RCA cable	Be sure the RCA audio cable is securely and entirely connected the mating connectors.
No audio	DIP switch settings are incorrect for your application	Refer to Monitor Applications at the back of this manual for proper setup.

<b>Flash Code Messages</b>		
<b>Flash Code (I/O Diode D102)</b>	<b>Code Description</b>	<b>Solution</b>
Flash Code 2	Possible IO board failure	First Check Connections. Turn off game, wait 10 seconds, turn game on. If Problem persists call IT tech support.
Flash Code 3	Info: Last reboot due to Watchdog time out.	Turn off game, wait 10 seconds, turn game on. If Problem persists call IT tech support.
Flash Code 4	Error When updating CID to latest Version	Typically CID failure. Turn off game, wait 10 seconds, turn game on. If Problem persists call IT tech support.
Flash Code 5	Updated USB CID was detected. This is not an error but a notification.	Turn off game, wait 10 seconds, turn game on. If Problem persists call IT tech support.
Flash Code 6	Disconnected Cabinet ID Device (CID) was detected.	Check USB connection. Turn off game, wait 10 seconds, turn game on. If Problem persists call IT tech support.
Flash Code 7	CID Malfunction. Typically CID is defective.	Turn off game, wait 10 seconds, turn game on. If Problem persists call IT tech support.
Flash Code 10	Error When updating USB IO board to latest version. Typically an IO board failure	Turn off game, wait 10 seconds, turn game on. If Problem persists call IT tech support.
Flash Code 11	Updated USB IO board to latest version. This is not an error but a notification.	Turn off game, wait 10 seconds, turn game on. If Problem persists call IT tech support.
Flash Code 12	A disconnected IO board was detected.	Turn off game, Check USB and power connections, turn game on. If Problem persists call IT tech support.
Flash Code 13	IO board malfunction. Typically IO board has failed.	Turn off game, wait 10 seconds, turn game on. If Problem persists call IT tech support.
Flash Code 14	Game is incompatible with USB IO board.	This usually means the wrong type of IO board. It does not match the system box software. Try turning off game, wait 10 seconds, turn game on. If problem persists call IT tech support.

<b>Miscellaneous Problems</b>		
<b>Symptom</b>	<b>Probable Cause</b>	<b>Solution</b>
Unable to exit Operator Menus.	DIPswitch SW202 position 4 is in the on position.	Set position 4 of SW202 to off. Press start to exit.
	Test switch wired from the I/O Board is closed.	Verify satellite test switch is not closed.
No fluorescent light	No 120 volts A.C. power going to the light fixture.	Verify A.C. voltage to the light fixture.
	Defective fluorescent light.	Replace fluorescent light.
	Defective starter	Replace the starter.
	Defective ballast.	Replace the ballast.
Coin Meter is not working	Defective Coin Meter	Replace with a known good one.
	Not wired properly	Connect one lead to +5 or +12 volts depending on device. The other lead to coin meter on Service Panel Pin 2.
	Defective I/O Board	Replace with a known good board.

# APPENDIX B – SHOWPIECE INPUT/OUTPUT CONNECTIONS (I/O POWER, TRACKBALL, ETC.)

For Standard Online Kit and Deluxe Retrofit Kit

## Trackball Harness Connector Pin Outs

I/O Board Connector	Trackball Connector
PIN WIRE #6 – Black	PIN WIRE #1 – Black
PIN WIRE #1 – Red	PIN WIRE #2 – Red
PIN WIRE #2 – Yellow	PIN WIRE #3 – Yellow
PIN WIRE #3 – Green	PIN WIRE #4 – Green
PIN WIRE #5 – Blue	PIN WIRE #5 – Blue
PIN WIRE #4 – Purple	PIN WIRE #6 – Purple

## I/O Power Cable Pin Outs

Pin Number	Wire Color	Function
1	Yellow	+ 12 Volts DC
2	Black	Ground
3	Red	+ 5 Volts DC
4	Black	Ground

## Control Panel J203 Connector Pin Outs

Pin	Color	Function
1	Green-White	Options
2	Brown-White	Left
3		N.C.
4	Yellow-White	Right
5	Violet-White	Flyby
6	Black	Volume GND
7	Black-White	Spin
8	Blue-White	Help
9	Red-White	Start
10	Black	Ground

## Lamps J202 Connector Pin Outs

Pin	Color	Function
1	Red-Black	Lamp Power – Buttons
5	Red-Yellow	Help Lamp
6	Red-Green	Options Lamp

## Speakers J301

Pin	Color	Function
1	Yellow-Red	Left Speaker +
2	Yellow-Green	Left Speaker -
3	White-Red	Right Speaker +
4	White-Green	Right Speaker -

## Service Panel

Pin	Color	Function
1	Red-Black	Meter Power
2	Red-Green	Coin Meter
3	Orange-White	Volume Up
4	Orange-Yellow	Volume Down
5		N.C.
6	Blue	Test
7	Black	Test Ground

## Coin Door J205

Pin	Color	Function
1	Red-Black	Lamp Power – Coin
2	Black	Lamp Ground – Coin
3		N.C.
4	Black	Bill Ground
5	Grey-White	Bill
6		N.C.
7		N.C.
8	Green-Blue	Coin 2
9	Red-Blue	Coin 1
10		N.C.
11	Black	Coin Ground

**Note:** N.C. stands for No Connection

# APPENDIX B – KIT JAMMA, TRACKBALL, AND I/O POWER CONNECTIONS

## JAMMA Harness Connection

SOLDER SIDE			PARTS SIDE		
WIRE COLOR	FUNCTION		FUNCTION	WIRE COLOR	
	*	A	1	*	
	*	B	2	*	
	*	C	3	*	
	*	D	4	*	
		E	5		
	*	F	6	*	
KEY		H	7	KEY	
	Count 2	J	8	Coin Counter	Red-Green
		K	9		
Yellow-Green	Left Speaker (-)	L	10	Left Speaker (+)	Yellow-Red
White-Green	Right Speaker (-)	M	11	Right Speaker (+)	White-Red
Green-Black	Video Green	N	12	Video Red	Red-Black
White	Video Sync	P	13	Video Blue	Blue-Black
		R	14	Video GND	White-Black
		S	15	Test	Blue
Green-Blue	Coin 2	T	16	Coin1	Red-Blue
		U	17	Start /Options	Red-White
		V	18		
		W	19		
		X	20		
		Y	21	Overview	Violet-White
		Z	22	Left	Brown-White
		a	23	Right	Yellow-White
Orange-Yellow	Volume Down	b	24	Volume Up	Orange-White
		c	25	Coin 3 (Bill)	Gray-White
		d	26		
Black	GND	e	27	GND	Black
Black	GND	f	28	GND	Black

**\*NOTE: Power is NOT routed through the JAMMA connector.**

### Trackball Harness Connector Pin Outs

I/O Board Connector	Trackball Connector
PIN WIRE #6 – Black	PIN WIRE #1 – Black
PIN WIRE #1 – Red	PIN WIRE #2 – Red
PIN WIRE #2 – Yellow	PIN WIRE #3 – Yellow
PIN WIRE #3 – Green	PIN WIRE #4 – Green
PIN WIRE #5 – Blue	PIN WIRE #5 – Blue
PIN WIRE #4 – Purple	PIN WIRE #6 – Purple

### I/O Power Cable Pin Outs

Pin Number	Wire Color	Function
1	Yellow	+ 12 Volts DC
2	Black	Ground
3	Red	+ 5 Volts DC
4	Black	Ground



## APPENDIX C REPLACEMENT PART NUMBERS

*Please refer to these IT part numbers when placing orders.*

Part Number	Description
925000328P	SHOWPIECE CABINET, US GOLDEN TEE GOLF (OFFLINE) 2013 COMPLETE UNIT
900146007R	CABINET IDENTIFICATION DEVICE, GOLF
915000285R	CABLE ASSY, AUDIO CABLE, 6 FT 2RCA PLUG TO 2RCA PLUG
915250304R	CABLE ASSY, I/O POWER FOR KITS
915000745	CABLE ASSY, POWER CORD. A.C.
915000315R	CABLE ASSY, SVGA, 6 FT. DB15HD M-M
915000310R	CABLE ASSY, USB CABLE, 6 FT.
915000173R	CABLE ASSY, TRACKBALL/GUN INTERFACE
915015400R	CABLE ASSY, HDMI, 15 FT.
999000060R	CARD READER BLANKING PLATE
938291715	CASH VAULT COMPLETE ASSEMBLY W/ \$1-5 DBA
825100294R	CONTROL PANEL OVERLAY GRAPHIC, DIECUT WITH CONTROL LABELS/TB HOLE
999000288	DBA, MARS \$1-5 BILL ACCEPTOR FOR IT CASH VAULT ONLY MODEL AE2481D5E
900328000R	I/O BOARD FOR GT GOLF 2013 DEDICATED
900100328R	I/O BOARD FOR GT GOLF 2013 KIT
840500250R	GT.COM LOGO CARD FOR NON-TOURN. CABINETS
925000328	KIT – GT GOLF (OFFLINE) 2013
815000328	MANUAL, GT GOLF 2013
820000328R	MARQUEE, GT GOLF 2013
850000001R	PUSHBUTTON ASSY, RED WITH VERTICAL MOUNTED SWITCH
850000003R	PUSHBUTTON ASSY, WHITE WITH VERTICAL MOUNTED SWITCH
840250100	QUICK INSTALL GUIDE, GT GOLF
830000294R	SIDE DECAL, GT GOLF
900065327R2	SYSTEM BOX, GT 2013
753304004	SYSTEM BOX FILTER
752259500R	SYSTEM BOX FILTER BRACKET
880000030R	TRACKBALL ASSY, 3" WHITE
885000030R	TRACKBALL PLATE FOR 3" TRACKBL WITH STANDOFFS

# APPENDIX D NIGHTHAWK COMPONENT DIAGRAMS

## Nighthawk System Box Diagram

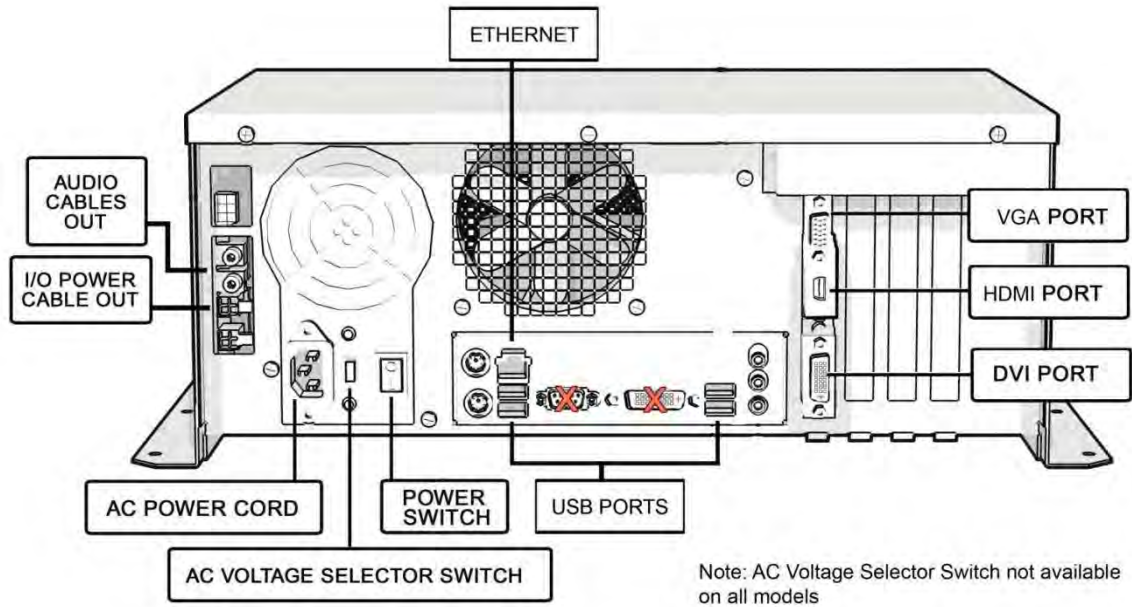

## I/O Board Diagram

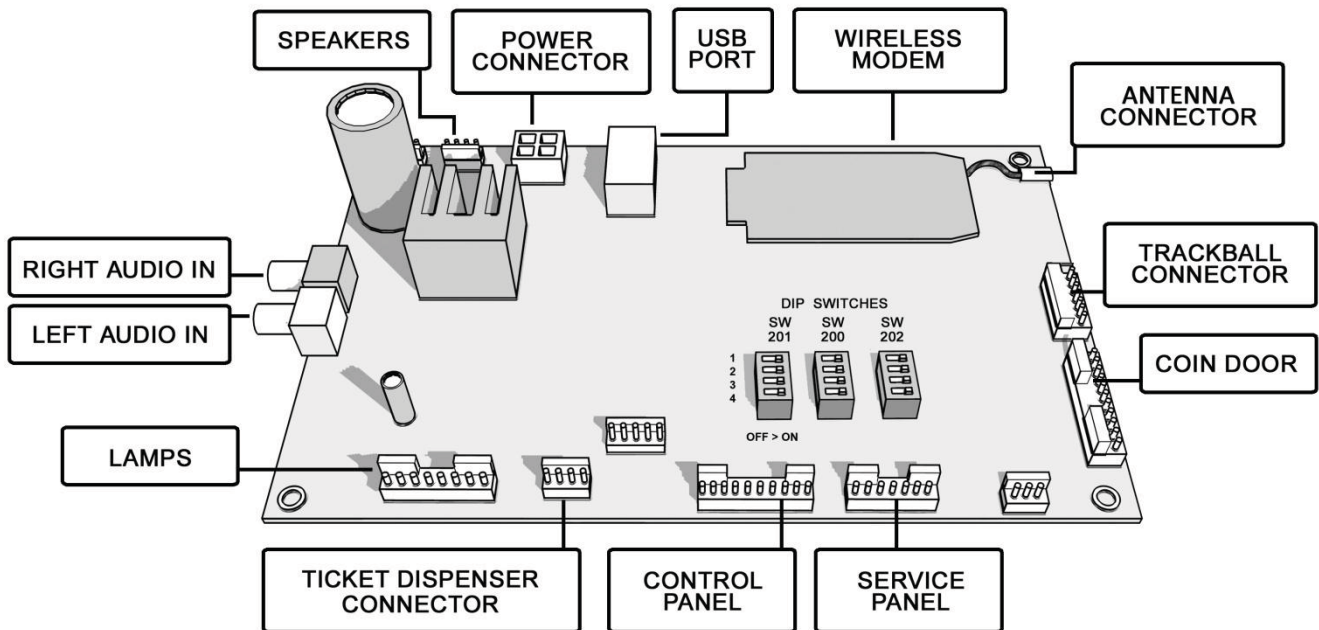

# CRT MONITOR APPLICATION

## IMPORTANT NOTE

### RESOLUTION SETTINGS

### I/O CARD DIAGRAM FOR ORIENTATION

### SECONDARY SETTINGS

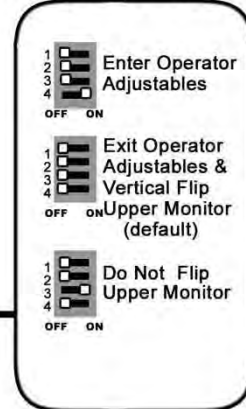
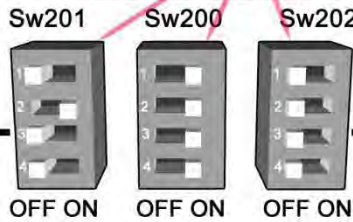
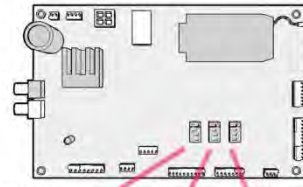
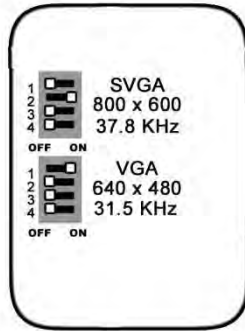

Sw200 ALWAYS ON  
Do Not Change  
Settings shown for Showpiece

## Video and I/O DIP Switch Settings for High Definition Televisions (HDTV)

# HDTV MONITOR APPLICATION

## IMPORTANT NOTE

### RESOLUTION SETTINGS

### I/O CARD DIAGRAM FOR ORIENTATION

### ADDITIONAL SETTINGS

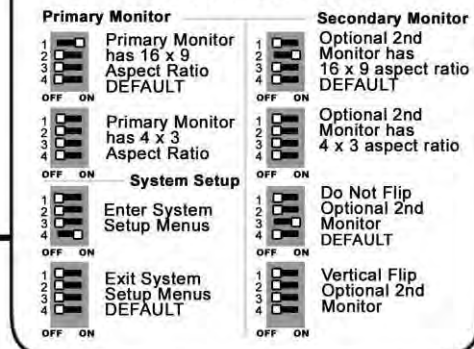
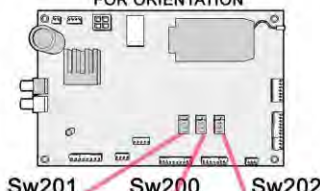
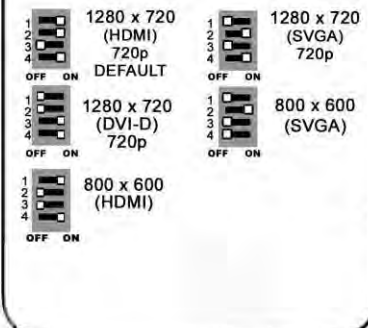

Sw200 ALWAYS ON  
Do Not Change  
Settings shown for Showpiece

Note: In the Additional Settings above, ONLY the ON switch matters for correct setup and operation.

# Showpiece Cabinet Connection Diagram

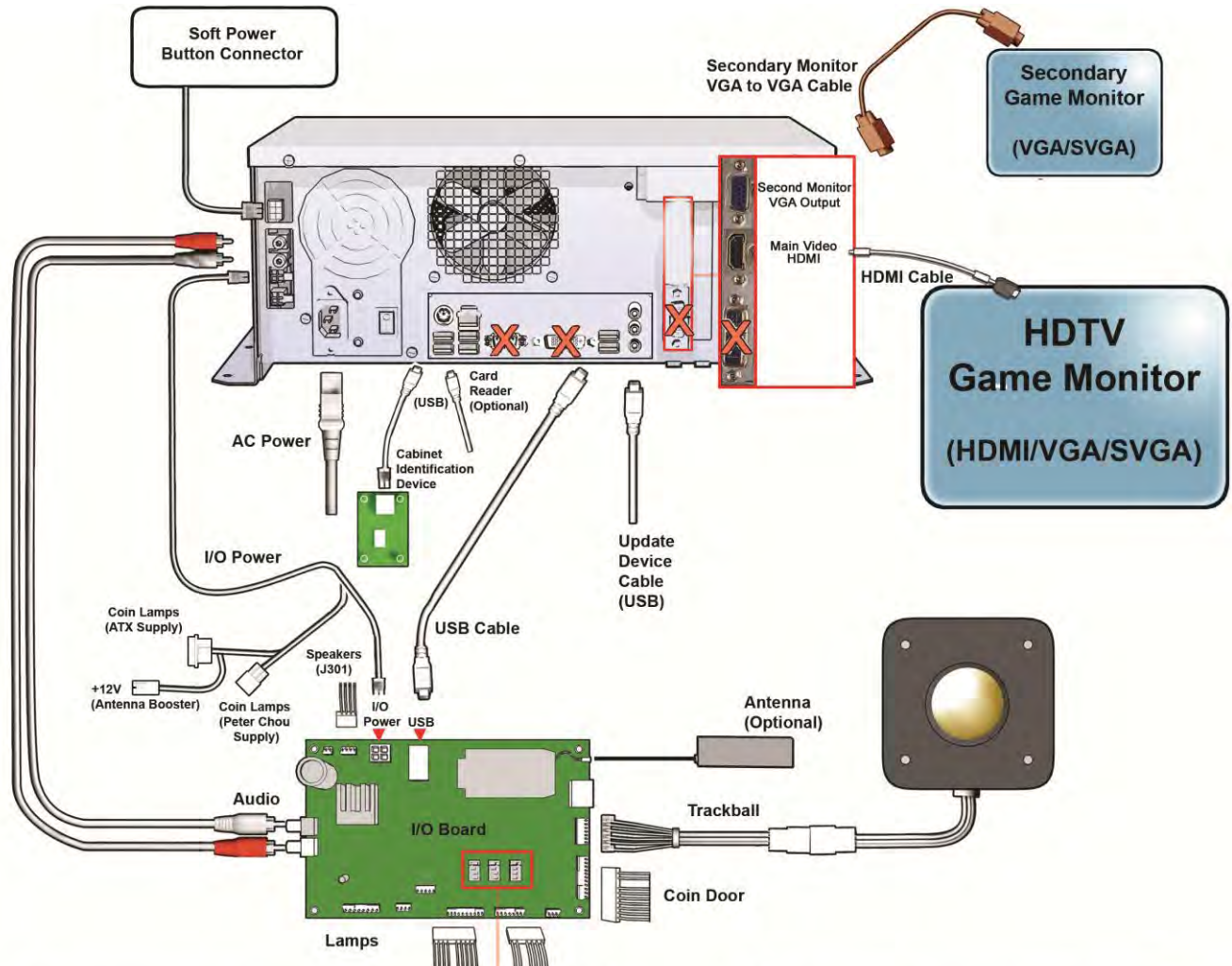

### RESOLUTION SETTINGS

1 2 3 4 OFF ON	1280 x 720 (HDMI) 720p DEFAULT	1 2 3 4 OFF ON	1280 x 720 (SVGA) 720p
1 2 3 4 OFF ON	1280 x 720 (DVI-D) 720p	1 2 3 4 OFF ON	800 x 600 (SVGA)
1 2 3 4 OFF ON	800 x 600 (HDMI)	1 2 3 4 OFF ON	640 x 480 (VGA)

1 2 3 4 OFF ON	1 2 3 4 OFF ON	1 2 3 4 OFF ON
Sw201	Sw200	Sw202

Sw200 ALWAYS ON  
Do Not Change  
Settings shown for Showpiece

### ADDITIONAL SETTINGS

1 2 3 4 OFF ON	Primary Monitor has 16 x 9 Aspect Ratio DEFAULT	1 2 3 4 OFF ON	Secondary Monitor Optional 2nd Monitor has 16 x 9 aspect ratio DEFAULT
1 2 3 4 OFF ON	Primary Monitor has 4 x 3 Aspect Ratio	1 2 3 4 OFF ON	Optional 2nd Monitor has 4 x 3 aspect ratio
1 2 3 4 OFF ON	System Setup Enter System Setup Menus	1 2 3 4 OFF ON	Do Not Flip Optional 2nd Monitor DEFAULT
1 2 3 4 OFF ON	Exit System Setup Menus DEFAULT	1 2 3 4 OFF ON	Vertical Flip Optional 2nd Monitor

# KIT Cabinet Connection Diagram

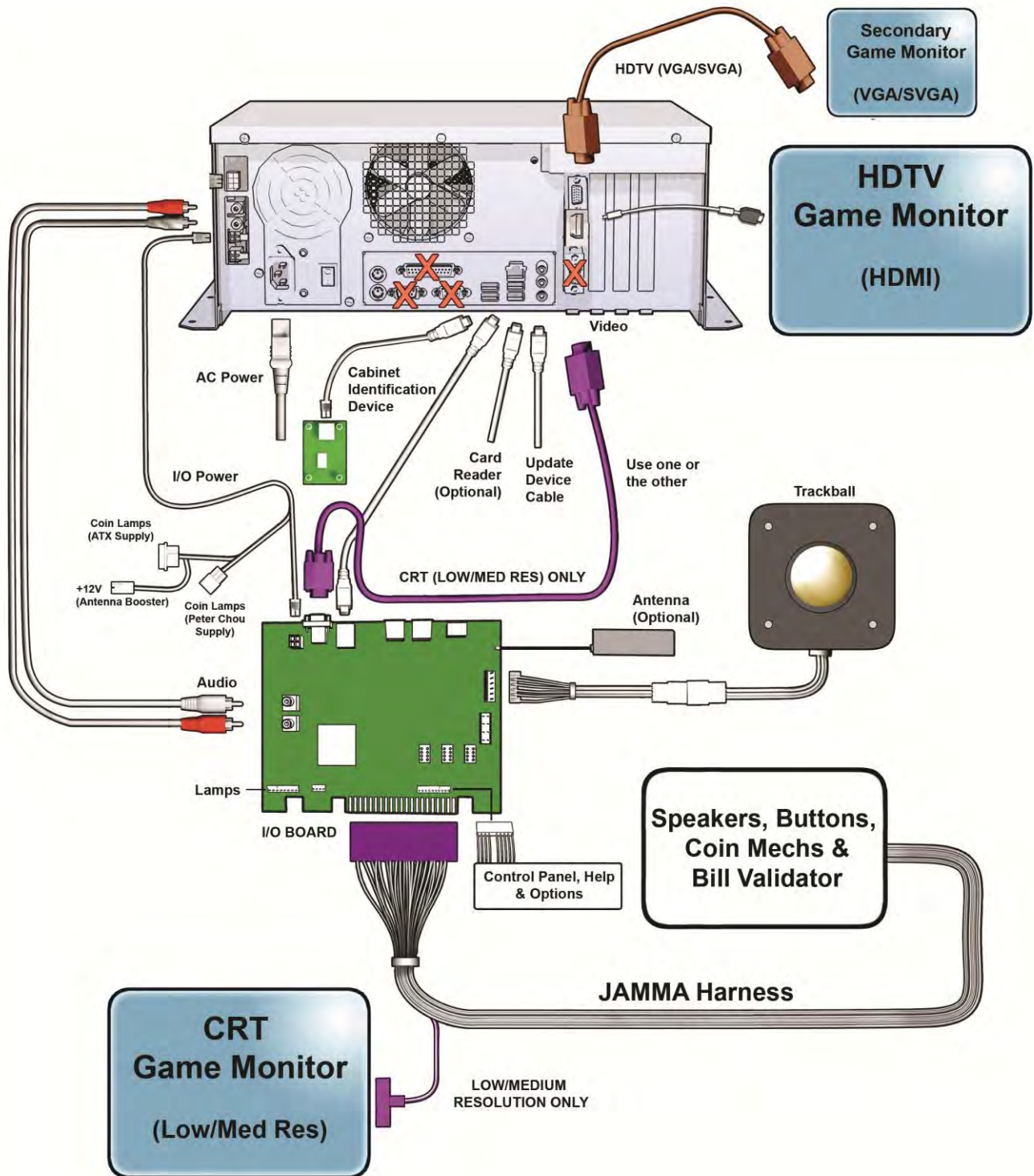













## APPENDIX E

### GNU General Public License

#### TERMS AND CONDITIONS FOR COPYING, DISTRIBUTION AND MODIFICATION

0. This License applies to any program or other work which contains a notice placed by the copyright holder saying it may be distributed under the terms of this General Public License. The "Program", below, refers to any such program or work, and a "work based on the Program" means either the Program or any derivative work under copyright law: that is to say, a work containing the Program or a portion of it, either verbatim or with modifications and/or translated into another language. (Hereinafter, translation is included without limitation in the term "modification".) Each licensee is addressed as "you".

Activities other than copying, distribution and modification are not covered by this License; they are outside its scope. The act of running the Program is not restricted, and the output from the Program is covered only if its contents constitute a work based on the Program (independent of having been made by running the Program). Whether that is true depends on what the Program does.

1. You may copy and distribute verbatim copies of the Program's source code as you receive it, in any medium, provided that you conspicuously and appropriately publish on each copy an appropriate copyright notice and disclaimer of warranty; keep intact all the notices that refer to this License and to the absence of any warranty; and give any other recipients of the Program a copy of this License along with the Program.

You may charge a fee for the physical act of transferring a copy, and you may at your option offer warranty protection in exchange for a fee.

2. You may modify your copy or copies of the Program or any portion of it, thus forming a work based on the Program, and copy and distribute such modifications or work under the terms of Section 1 above, provided that you also meet all of these conditions:

a) You must cause the modified files to carry prominent notices stating that you changed the files and the date of any change.

b) You must cause any work that you distribute or publish, that in whole or in part contains or is derived from the Program or any part thereof, to be licensed as a whole at no charge to all third parties under the terms of this License.

c) If the modified program normally reads commands interactively when run, you must cause it, when started running for such interactive use in the most ordinary way, to print or display an announcement including an appropriate copyright notice and a notice that there is no warranty (or else, saying that you provide a warranty) and that users may redistribute the program under these conditions, and telling the user how to view a copy of this License. (Exception: if the Program itself is interactive but does not normally print such an announcement, your work based on the Program is not required to print an announcement.) These requirements apply to the modified work as a whole. If identifiable sections of that work are not derived from the Program, and can be reasonably considered independent and separate works in themselves, then this License, and its terms, do not apply to those sections when you distribute them as separate works. But when you distribute the same sections as part of a whole which is a work based on the Program, the distribution of the whole must be on the terms of this License, whose permissions for other licensees extend to the entire whole, and thus to each and every part regardless of who wrote it.

Thus, it is not the intent of this section to claim rights or contest your rights to work written entirely by you; rather, the intent is to exercise the right to control the distribution of derivative or collective works based on the Program.

In addition, mere aggregation of another work not based on the Program with the Program (or with a work based on the Program) on a volume of a storage or distribution medium does not bring the other work under the scope of this License.

3. You may copy and distribute the Program (or a work based on it, under Section 2) in object code or executable form under the terms of Sections 1 and 2 above provided that you also do one of the following:

a) Accompany it with the complete corresponding machine-readable source code, which must be distributed under the terms of Sections 1 and 2 above on a medium customarily used for software interchange; or,

b) Accompany it with a written offer, valid for at least three years, to give any third party, for a charge no more than your cost of physically performing source distribution, a complete machine-readable copy of the corresponding source code, to be distributed under the terms of Sections 1 and 2 above on a medium customarily used for software interchange; or,

c) Accompany it with the information you received as to the offer to distribute corresponding source code. (This alternative is allowed only for noncommercial distribution and only if you received the program in object code or executable form with such an offer, in accord with Subsection b above.)

The source code for a work means the preferred form of the work for making modifications to it. For an executable work, complete source code means all the source code for all modules it contains, plus any associated interface definition files, plus the scripts used to control compilation and installation of the executable. However, as a special exception, the source code distributed need not include anything that is normally distributed (in either source or binary form) with the major components (compiler, kernel, and so on) of the operating system on which the executable runs, unless that component itself accompanies the executable.

If distribution of executable or object code is made by offering access to copy from a designated place, then offering equivalent access to copy the source code from the same place counts as distribution of the source code, even though third parties are not compelled to copy the source along with the object code.

4. You may not copy, modify, sublicense, or distribute the Program except as expressly provided under this License. Any attempt otherwise to copy, modify, sublicense or distribute the Program is void, and will automatically terminate your rights under this License. However, parties who have received copies, or rights, from you under this License will not have their licenses terminated so long as such parties remain in full compliance.

5. You are not required to accept this License, since you have not signed it. However, nothing else grants you permission to modify or distribute the Program or its derivative works. These actions are prohibited by law if you do not accept this License. Therefore, by modifying or distributing the Program (or any work based on the Program), you indicate your acceptance of this License to do so, and all its terms and conditions for copying, distributing or modifying the Program or works based on it.

6. Each time you redistribute the Program (or any work based on the Program), the recipient automatically receives a license from the original licensor to copy, distribute or modify the Program subject to these terms and conditions. You may not impose any further restrictions on the recipients' exercise of the rights granted herein. You are not responsible for enforcing compliance by third parties to this License.

7. If, as a consequence of a court judgment or allegation of patent infringement or for any other reason (not limited to patent issues), conditions are imposed on you (whether by court order, agreement or otherwise) that contradict the conditions of this License, they do not excuse you from the conditions of this License. If you cannot distribute so as to satisfy simultaneously your obligations under this License and any other pertinent obligations, then as a consequence you may not distribute the Program at all. For example, if a patent license would not

permit royalty-free redistribution of the Program by all those who receive copies directly or indirectly through you, then the only way you could satisfy both it and this License would be to refrain entirely from distribution of the Program.

If any portion of this section is held invalid or unenforceable under any particular circumstance, the balance of the section is intended to apply and the section as a whole is intended to apply in other circumstances.

It is not the purpose of this section to induce you to infringe any patents or other property right claims or to contest validity of any such claims; this section has the sole purpose of protecting the integrity of the free software distribution system, which is implemented by public license practices. Many people have made generous contributions to the wide range of software distributed through that system in reliance on consistent application of that system; it is up to the author/donor to decide if he or she is willing to distribute software through any other system and a licensee cannot impose that choice.

This section is intended to make thoroughly clear what is believed to be a consequence of the rest of this License.

8. If the distribution and/or use of the Program is restricted in certain countries either by patents or by copyrighted interfaces, the original copyright holder who places the Program under this License may add an explicit geographical distribution limitation excluding those countries, so that distribution is permitted only in or among countries not thus excluded.

In such case, this License incorporates the limitation as if written in the body of this License.

9. The Free Software Foundation may publish revised and/or new versions of the General Public License from time to time. Such new versions will be similar in spirit to the present version, but may differ in detail to address new problems or concerns.

Each version is given a distinguishing version number. If the Program specifies a version number of this License which applies to it and "any later version", you have the option of following the terms and conditions either of that version or of any later version published by the Free Software Foundation. If the Program does not specify a version number of this License, you may choose any version ever published by the Free Software Foundation.

10. If you wish to incorporate parts of the Program into other free programs whose distribution conditions are different, write to the author to ask for permission. For software which is copyrighted by the Free Software Foundation, write to the Free Software Foundation; we sometimes make exceptions for this. Our decision will be guided by the two goals of preserving the free status of all derivatives of our free software and of promoting the sharing and reuse of software generally.

#### NO WARRANTY

11. BECAUSE THE PROGRAM IS LICENSED FREE OF CHARGE; THERE IS NO WARRANTY FOR THE PROGRAM, TO THE EXTENT PERMITTED BY APPLICABLE LAW. EXCEPT WHEN OTHERWISE STATED IN WRITING THE COPYRIGHT HOLDERS AND/OR OTHER PARTIES PROVIDE THE PROGRAM "AS IS" WITHOUT WARRANTY OF ANY KIND, EITHER EXPRESSED OR IMPLIED, INCLUDING, BUT NOT LIMITED TO, THE IMPLIED WARRANTIES OF MERCHANTABILITY AND FITNESS FOR A PARTICULAR PURPOSE. THE ENTIRE RISK AS TO THE QUALITY AND PERFORMANCE OF THE PROGRAM IS WITH YOU. SHOULD THE PROGRAM PROVE DEFECTIVE, YOU ASSUME THE COST OF ALL NECESSARY SERVICING, REPAIR OR CORRECTION.

12. IN NO EVENT UNLESS REQUIRED BY APPLICABLE LAW OR AGREED TO IN WRITING WILL ANY COPYRIGHT HOLDER, OR ANY OTHER PARTY WHO MAY MODIFY AND/OR REDISTRIBUTE THE PROGRAM AS PERMITTED ABOVE, BE LIABLE TO YOU FOR DAMAGES, INCLUDING ANY GENERAL, SPECIAL, INCIDENTAL OR CONSEQUENTIAL DAMAGES ARISING OUT OF THE USE OR INABILITY TO USE THE PROGRAM (INCLUDING BUT NOT LIMITED TO LOSS OF DATA OR DATA BEING RENDERED INACCURATE OR LOSSES SUSTAINED BY YOU OR THIRD PARTIES OR A FAILURE OF THE PROGRAM TO OPERATE WITH ANY OTHER PROGRAMS), EVEN IF SUCH HOLDER OR OTHER PARTY HAS BEEN ADVISED OF THE POSSIBILITY OF SUCH DAMAGES.

How to Apply These Terms to Your New Programs If you develop a new program, and you want it to be of the greatest possible use to the public, the best way to achieve this is to make it free software which everyone can redistribute and change under these terms.

To do so, attach the following notices to the program. It is safest to attach them to the start of each source file to most effectively convey the exclusion of warranty; and each file should have at least the "copyright"

line and a pointer to where the full notice is found.

One line to give the program's name and an idea of what it does.

Copyright (C) yyyy name of author

This program is free software; you can redistribute it and/or modify it under the terms of the GNU General Public License as published by the Free Software Foundation; either version 2 of the License, or (at your option) any later version.

This program is distributed in the hope that it will be useful, but WITHOUT ANY WARRANTY; without even the implied warranty of MERCHANTABILITY or FITNESS FOR A PARTICULAR PURPOSE. See the GNU General Public License for more details.

You should have received a copy of the GNU General Public License along with this program; if not, write to the Free Software Foundation, Inc., 59 Temple Place - Suite 330, Boston, MA 02111-1307, USA.

**Copyright 2004 Incredible Technologies, Inc. (IT). Certain programs, identified at IT's Website are free software subject to an associated license.**

1. Because certain programs are licensed free of charge, see it's website, there is no warranty for such programs to the extent permitted by applicable law. Except when otherwise stated in writing the copyright holders and/or other parties provide those programs "as is" without warranty of any kind, either expressed or implied, including, but not limited to, the implied warranties of merchantability and fitness for a particular purpose. The entire risk as to the quality and performance of those programs is with you. Should the programs prove defective, you assume the cost of all necessary servicing, repair or correction.

2. In no event unless required by applicable law or agreed to in writing will any copyright holder, or any other party who may modify and/or redistribute those programs be liable to you for damages including any general, special, incidental or consequential damages arising out of the use or inability to use those programs (including but not limited to loss of data or data being rendered inaccurate or losses sustained by you or third parties or a failure of those programs to operate with any other programs), even if such holder or other party has been advised of the possibility of such damages.

A complete machine-readable copy of the source code of those programs and associated license is available to any third party, at the it website.

## APPENDIX F MENU NAVIGATION SHORTCUTS

### Change Collection Settings

- Push the red System Setup button inside the coin door
- Select **General Settings** menu
- Select **Operator Adjustables** menu
- Select **Collection Settings** menu
- Select the menu that you want changed

### Add Operator Free Cash

- Push the red System Setup button inside the coin door
- Select **Collection and Earnings**
- Select **Add Free Cash**
- Move the trackball left/right to select the desired dollar amount

## GAME ICON DESCRIPTIONS

### Cooling Icon

The cooling icon (pictured right) will appear in the game's attract mode to warn you that a fan is not operating at minimum recommended standards. If the fans do not operate at suggested levels it may cause your game to overheat and fail.

Call Incredible Technologies Technical Support at 847-870-7027 x121 for assistance.





**APPENDIX G  
MOUNTING TEMPLATES**



MONITOR  
DIRECTION

# TRACKBALL ORIENTATION DIAGRAM

(VIEWED FROM UNDERSIDE OF CONTROL PANEL)

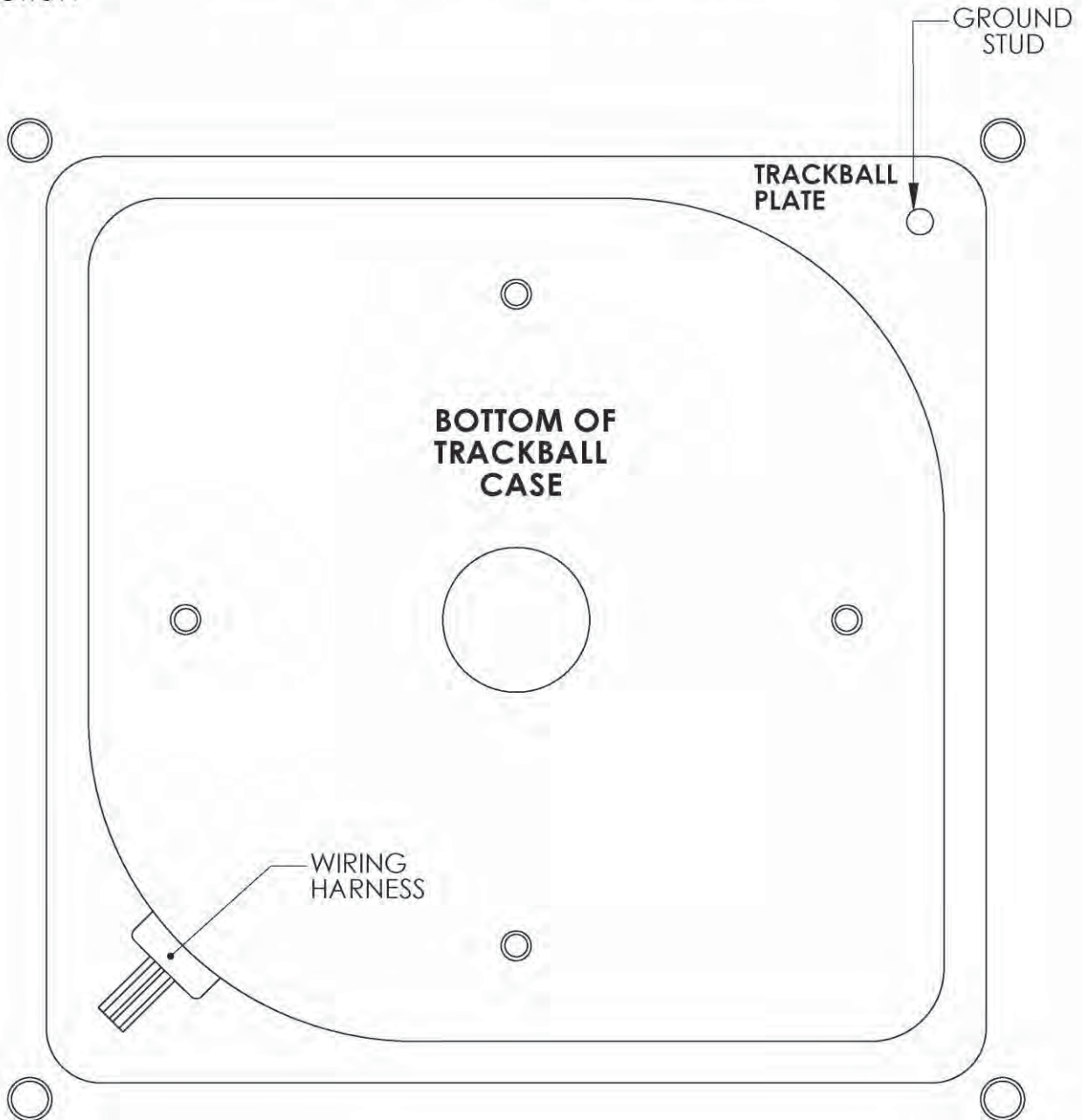

**INSTALLATION NOTES:**

- 1) THE WIRING HARNESS SHOULD POINT AWAY FROM THE MONITOR AND TO THE LEFT.
- 2) GROUND PIN SHOULD BE TOWARD THE MONITOR AND ON THE RIGHT SIDE.





# TRACKBALL MOUNTING TEMPLATE

## TOOLS REQUIRED:

DRILL, 9/32" OR 5/16" & 3/4" DRILL BITS, SABRE SAW, SCISSORS, & ROUTER

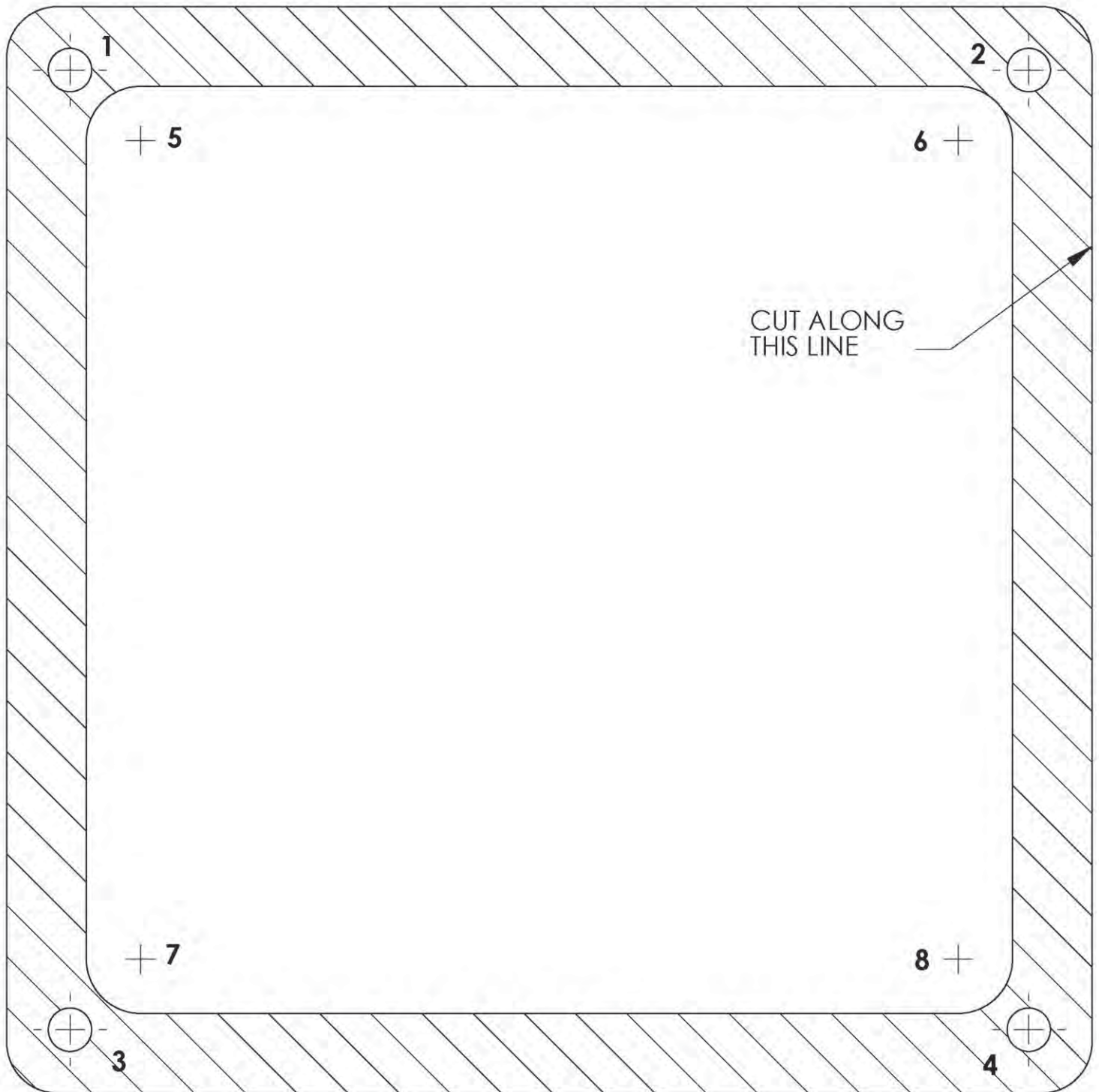

## INSTRUCTIONS:

- 1) CUT THE TEMPLATE OUT WITH A PAIR OF SCISSORS ALONG THE NOTED LINE. TAPE THIS TEMPLATE TO THE TOP OF THE CONTROL PANEL AS FAR AWAY FROM THE MONITOR AS POSSIBLE, MAKING SURE THAT THE TRACKBALL WILL CLEAR THE CABINET BENEATH IT.
- 2) USING A SHARP OBJECT, MARK THE (8) POINTS SHOWN HERE ON THE CONTROL PANEL. USING A PENCIL, TRACE THE OUTSIDE OF THE TEMPLATE. REMOVE THE TEMPLATE.
- 3) DRILL HOLES 1-4 WITH THE 9/32" OR 5/16" DRILL BIT.
- 4) DRILL HOLES 5-8 WITH THE 3/4" DRILL BIT.
- 5) ROUTE THE CROSSHATCHED REGION TO A DEPTH OF ABOUT .075" (ABOUT THE THICKNESS OF A NICKEL).
- 6) USING THE SABRE SAW CUT OUT THE CENTER PORTION BY CUTTING BETWEEN HOLES 5-8.



# LEFT BUTTON DRILL TEMPLATE

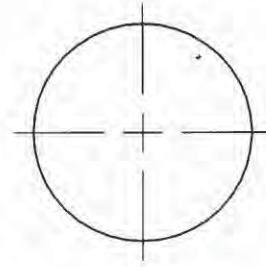
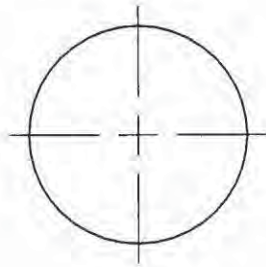

**2**

THE CENTER OF  
BUTTON #2 SHOULD  
BE LOCATED 2.75"  
ABOVE, AND 9" TO  
THE LEFT OF THE  
CENTER OF THE  
TRACKBALL.

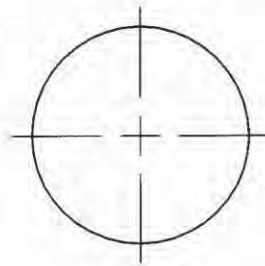



# RIGHT BUTTON DRILL TEMPLATE

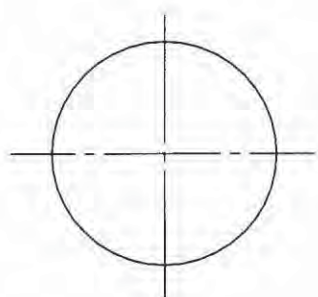

**1**

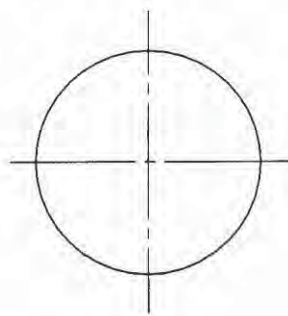
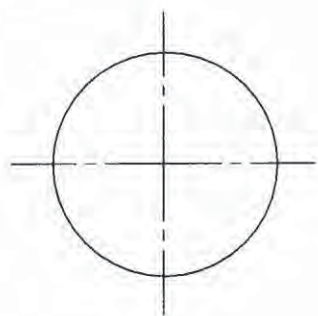
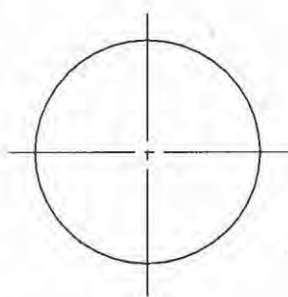

- 1) THE CENTER OF BUTTON #1 SHOULD BE LOCATED APPROX. 8" TO THE RIGHT OF THE CENTER OF THE TRACKBALL WITH THE BUTTONS CENTERED ABOUT THE TRACKBALL VERTICALLY.
- 2) FOR GOLDEN TEE FORE CABINETS THE #1 BUTTON HOLE SHOULD BE ALIGNED WITH THE EXISTING BACKSPIN BUTTON HOLE.



# Contact Information

## IT Sales and Service

To purchase additional Golden Tee machines or any of IT's other fine products please visit IT's website at [www.itsgames.com](http://www.itsgames.com) and click on **PRODUCTS!**

### General Numbers

#### IT Sales Hotline:

800-262-0323 x383

847-870-7027 x383

#### Technical Support, Warranty & Repair:

Incredible Technologies, Inc.

800-262-0323 x380 or x381

847-870-7027 x380 or x381

847-454-9008 Fax

#### Parts and Customer Service:

Incredible Technologies, Inc.

800-262-0323 x386

847-870-7027 x 386

847-454-9156 Fax

#### Operator Services:

Incredible Technologies, Inc.

800-262-0323 x382

847-870-7027 x382

847-454-9155 Fax

#### Accounting

Incredible Technologies, Inc.

800-262-0323 x382

847-870-7027 x382

847-454-9007 Fax

#### IT Mailing Address:

Incredible Technologies, Inc.  
200 Corporate Woods Parkway  
Vernon Hills, IL 60061

#### ITNet Registration Fax Number

**847-454-9155**

#### Sales Fax Number

**847-454-9156**

General Fax Number: 847-870-0120  
Tech Services Fax Number: 847-454-9008

## IT Vendor Information

#### Mars Technical Service:

Phone: 800-345-8172

#### Happ Controls:

Phone: 888-289-4277



**Incredible Technologies, Inc.**  
200 Corporate Woods Parkway  
Vernon Hills, IL 60061

Phone (847) 870-7027 (800) 262-0323  
[www.itsgames.com](http://www.itsgames.com)