



Showpiece and Kit Installation Manual & User Guide



WARNINGS AND NOTICES

NOTICE

- This game is intended to be operated for amusement purposes only. It is not to be operated in violation of any federal, state, or local laws or regulations. As the owner and/or operator of this game you are responsible for its operation in compliance with such laws and regulations. The factory settings for this game may require adjustment in order to comply with the laws and/or regulations in the jurisdiction where the game is located. It is the sole responsibility of the operator to determine what laws and/or regulations are applicable and to make any adjustments to the game before operating it for its intended purpose.
- This manual and the information contained within is subject to change without notice.
- The Showpiece cabinet is intended for use with the Showpiece Integrated Stand (Model 304S).

WARNING

- Use of unauthorized parts or making any unauthorized modifications will void the warranty and may result in the game operating in an unsafe or incorrect manner.
- If the supply cord is damaged, it must be replaced by a special cord or assembly available from the manufacturer or its service agent.
- This cabinet is not suitable for installation in an area where a water jet would be used. The cabinet must not be cleaned by a water jet.

WARRANTY, REPAIR, AND RETURN POLICY

- 90-day warranty on all electronic components. All warranty periods begin on the date of purchase from Incredible Technologies, Inc.
- There is a minimum \$75.00 service charge for all non-warranty repairs or returns.
- For all servicing, return to Incredible Technologies, Inc.
- ANY non-factory repair or attempted repair voids warranty.

RETURN MERCHANDISE AUTHORIZATION

- All returned merchandise must have a Return Merchandise Authorization (RMA) number marked clearly on the outside of the package.
- You must obtain all RMA numbers from Incredible Technologies. Please have the product's Cabinet Identification Device number available when calling for an RMA number.
- Merchandise returned without an RMA number will not be accepted.
- Warranty may be void if serial number or security labels are tampered with or removed. **Opening the Nighthawk System Box will void your warranty.**
- Advance replacement hardware will be shipped to the customer address on file unless specified otherwise.
- Advance replacement hardware will be billed to the customer until Incredible Technologies, Inc. receives the returned merchandise, at which time a credit will be issued.
- All repairs and/or replacements will ship as soon as possible after receipt or request (subject to availability).

PAYMENT FOR AND STORAGE OF REPAIR MATERIALS

Materials sent to IT for repair must be paid for according to current price schedules and in a reasonable time. Storage fees for repaired equipment will be charged at a rate of \$50.00 (Fifty US Dollars) per calendar month or fraction thereof after 90 (Ninety) days from notice to the customer that the repairs are complete. IT reserves the right to resell repaired equipment to cover accumulated storage charges when the accumulated storage charge reaches 100% (One Hundred Percent) of the repaired items' then-current replacement cost.

- INCREDIBLE TECHNOLOGIES, INC

TERM SOFTWARE LICENSE

Incredible Technologies, Inc. ("IT,") hereby offers you ("Licensee") the right to install and use certain copyrighted computer software produced by IT under the following terms and conditions. This License shall govern the use of the software known as "Golden Tee LIVE 2016" ("Update") when applied as an update to pre-existing Golden Tee LIVE-equipped hardware ("GT Cabinets") equipped with an earlier version of the Golden Tee LIVE software ("Prior Version.") or to Updates included in the purchase of a hardware/software package which constitutes a functionally complete Golden Tee LIVE game unit.

1) Term Licensing Fee

The Term Licensing Fee ("TLF") shall be as follows:

As set forth in the periodic payment agreement between IT and Licensee at the time the Term License is purchased. If no TLF is set forth in any such agreement, the TLF shall be equal to the monthly payment set forth in IT's then-current pricing schedule.

2) Term

The license shall be valid on the first date the Update is both installed on a GT Cabinet and authorized by ITNet for play on that GT Cabinet and for thirty (30) days thereafter. The term shall automatically renew for another thirty (30) days upon the timely payment of the TLF, as agreed upon by the parties, up to a total of twelve (12) complete terms. If the TLF is not paid within fifteen (15) days of the due date, this license shall automatically terminate. At the end of twelve (12) complete terms, this License shall terminate and the parties shall become bound by the terms of the Perpetual Software License attached hereto.

3) License Rights

Licensee shall have the right to utilize the Update on authorized GT Cabinets in the normal course of business and as controlled by the Rules of ITNet, as set forth in a separate "Operator Agreement" document, the terms and conditions of which, where not conflicting with the terms and conditions herein, are hereby incorporated by reference. Updates may only be operated on GT Cabinets which are installed in commercial locations, as that term is defined by IT, and to which there is general access by all parties with a general right to enter the location where the GT Cabinet is operated.

4) Legal Operation

Updates include various features which may not be lawful to operate in any given jurisdiction. No provision of any feature, or its licensure to Licensee under the terms herein shall be deemed as advice that operation of that feature is lawful or not lawful in any given jurisdiction. Licensee shall make reasonable efforts to disable any user-adjustable feature which they know or should have known as not lawful to operate in the location where a GT Cabinet with an Update is being operated.

5) Termination and Rollback

In the event that this License is terminated for whatever reason, Licensee shall have absolutely no right to operate any GT Cabinet upon which an Update has been installed. IT reserves the absolute right, at its sole discretion, to terminate the operation of any GT Cabinet upon which an unlicensed Update has been installed. If Licensee wishes to restore such a GT Cabinet to operating condition without acquiring a new License for the Update, IT will roll-back that GT Cabinet, at no charge to the Licensee, to the Prior Version upon return (at Licensee's expense) of the required hardware to IT's service center.

6) Governing Law and Jurisdiction

The validity and construction of this License and of the rights and obligations set forth herein shall be determined and governed by the laws of the State of Illinois. The parties hereby submit to the Jurisdiction of any state or federal court in Cook County Illinois. Licensees operating outside the borders of the United States of America, regardless of their citizenship or residency, explicitly agree to allow any assets they may have in the USA or any other foreign country to be attached, garnished, forfeited or otherwise reached by any legal act if, after due process of law, they are found to be liable to IT for damages by reason of breach of this License.

7) Warranty

If the Licensee discovers any physical defect in the media (disk, EPROM, flash media, etc.) on which the Update is distributed or in the documentation, which in the opinion of Incredible Technologies, Inc. (IT) prevents the product from being used as reasonably intended, IT will replace the media or documentation at no charge. The purchaser must return the item to be replaced, with proof of purchase, to IT within 90 days after taking delivery of the Update.

8) Disclaimer of Remedies

Acceptance of this License and installation of the Update includes disclaimer and waiver of any and all implied, statutory, or common-law warranties, including warranties of merchantability and fitness for a particular purpose, and limits the purchaser's remedy to returning the Update to IT for replacement.

IT makes no warranty or representation, either express or implied, with respect to Updates, their quality, performance, merchantability, or fitness for a particular purpose. Updates are licensed "as is," and the licensee assumes the entire risk as to their quality and performance other than as explicitly set forth herein.

Acceptance of this License and installation of the Update includes disclaimer and waiver of any and all direct, indirect, special, incidental, or consequential damages arising out of the use or inability to use the Update, even if advised of the possibility of such damages. The warranty and remedies set forth above are exclusive and in lieu of all others, oral or written, express or implied. No person, seller, dealer, agent, or employee is authorized to make any modification or addition to this limited warranty.

In jurisdictions which do not allow the exclusion of implied warranties or liability for incidental or consequential damages, acceptance of this License and installation of the Update includes stipulation that the most minimal requirements of the law of those jurisdictions shall govern any additional required additional rights of Licensee.

9) Severability

If any provision of this License shall be held by a court of competent jurisdiction to be illegal, invalid or unenforceable, the parties nevertheless agree that the court should endeavor to give effect to the parties' intentions as reflected in the provision, and the remaining provisions shall remain in full force and effect.

PERPETUAL SOFTWARE LICENSE

Incredible Technologies, Inc. ("IT,") hereby offers you ("Licensee") the right to install and use certain copyrighted computer software produced by IT under the following terms and conditions. This License shall govern the use of the software known as "Golden Tee LIVE 2016" ("Update") when applied as an update to pre-existing Golden Tee LIVE-equipped hardware ("GT Cabinets") equipped with an earlier version of the Golden Tee LIVE software ("Prior Version.") or to Updates included in the purchase of a hardware/software package which constitutes a functionally complete Golden Tee LIVE game unit.

1) Licensing Fee

The Licensing Fee ("LF") shall be as follows:

- US\$0.00 (Zero United States Dollars and zero cents.)

2) Term

The License shall be valid on the first date that both the LF is paid for the Update and it is installed on a GT Cabinet. If the Update has been offered or sold to you under the terms of a Term Software License, the terms of this License shall become applicable if and when the Term Software License terminates in favor of this Perpetual Software License, as set forth in the Term Software License. The term shall be perpetual and throughout the Universe for the Update on the GT Cabinet upon which it is installed at the time the LF is paid. Updates are not transferrable to any other GT Cabinet, for any reason. If a GT Cabinet with an Update is destroyed or otherwise taken out of operation, this License shall terminate.

3) License Rights

Licensee shall have the right to utilize the Update on authorized GT Cabinets in the normal course of business and as controlled by the Rules of ITNet, as set forth in a separate "Operator Agreement" document, the terms and conditions of which, where not conflicting with the terms and conditions herein, are hereby incorporated by reference. Updates may only be operated on GT Cabinets which are installed in commercial locations, as that term is defined by IT, and to which there is general access by all parties with a general right to enter the location where the GT Cabinet is operated.

4) Legal Operation

Updates include various features which may not be lawful to operate in any given jurisdiction. No provision of any feature, or its licensure to Licensee under the terms herein shall be deemed as advice that operation of that feature is lawful or not lawful in any given jurisdiction. Licensee shall make reasonable efforts to disable any user-adjustable feature which they know or should have known as not lawful to operate in the location where a GT Cabinet with an Update is being operated.

5) Termination and Rollback

In the event that this License is terminated for whatever reason, Licensee shall have absolutely no right to operate any GT Cabinet upon which an Update has been installed. IT reserves the absolute right, at its sole discretion, to terminate the operation of any GT Cabinet upon which an unlicensed Update is installed. If Licensee wishes to restore such a GT Cabinet to operating condition without acquiring a new License for the Update, IT will roll-back that GT Cabinet, at no charge to the Licensee, to the Prior Version upon return (at Licensee's expense) of the required hardware to IT's service center.

6) Governing Law and Jurisdiction

The validity and construction of this License and of the rights and obligations set forth herein shall be determined and governed by the laws of the State of Illinois. The parties hereby submit to the Jurisdiction of any state or federal court in Cook County Illinois. Licensees operating outside the borders of the United States of America, regardless of their citizenship or residency, explicitly agree to allow any assets they may have in the USA or any other foreign country to be attached, garnished, forfeited or otherwise reached by any legal act if, after due process of law, they are found to be liable to IT for damages by reason of breach of this License.

7) Warranty

If the Licensee discovers any physical defect in the media (disk, EPROM, flash media, etc.) on which the Update is distributed or in the documentation, which in the opinion of Incredible Technologies, Inc. (IT) prevents the product from being used as reasonably intended, IT will replace the media or documentation at no charge. The purchaser must return the item to be replaced, with proof of purchase, to IT within 90 days after taking delivery of the Update.

8) Disclaimer and Waiver of Remedies

Acceptance of this License and installation of the Update includes disclaimer and waiver of any and all implied, statutory, or common-law warranties, including warranties of merchantability and fitness for a particular purpose, and limits the purchaser's remedy to returning the Update to IT for replacement.

IT makes no warranty or representation, either express or implied, with respect to Updates, their quality, performance, merchantability, or fitness for a particular purpose. Updates are licensed "as is," and the Licensee, by installing the Update, assumes the entire risk as to their quality and performance other than as explicitly set forth herein.

Acceptance of this License and installation of the Update includes disclaimer and waiver of any and all direct, indirect, special, incidental, or consequential damages arising out of the use or inability to use the Update, even if advised of the possibility of such damages. The warranty and remedies set forth above are exclusive and in lieu of all others, oral or written, express or implied. No person, seller, dealer, agent, or employee is authorized to make any modification or addition to this limited warranty.

In jurisdictions which do not allow the exclusion of implied warranties or liability for incidental or consequential damages, acceptance of this License and installation of the Update includes stipulation that the most minimal requirements of the law of those jurisdictions shall govern any additional required additional rights of Licensee.

9) Severability

If any provision of this License shall be held by a court of competent jurisdiction to be illegal, invalid or unenforceable, the parties nevertheless agree that the court should endeavor to give effect to the parties' intentions as reflected in the provision, and the remaining provisions shall remain in full force and effect.



Golden Tee LIVE 2021 Manual & User Guide

TABLE OF CONTENTS

- Table of Contents 1
- SHOWPIECE CABINET 5
- Leg Leveler Adjustment 5
- Mount Main Screen Display 5
- Install Marquee..... 5
- HDTV DIP SWITCH SETTINGS and NIGHTHAWK SYSTEM BOX..... 6
- Video Connections for HDTV 7
- Final Check..... 8
- Apply Power 8
- General Cabinet Maintenance..... 9
- Care and Cleaning of Rubber Bumper 9
- Nighthawk Air Filter 9
- Trackball Maintenance..... 9
- Care and Cleaning of Cooling Fans and Vents 9
- SHOWPIECE Cabinet Update & Repair Procedures..... 10
- Keypad 10
- System Box 10
- I/O Board 10
- Cash Vault..... 11
- Control Panel 12
- Antenna..... 14
- Card Reader..... 14
- Keypad 15
- ONLINE KIT CONTENTS..... 16
- Kit Installation 16
- Recommended Tools..... 16
- Installation Preparation 17
- Preparing The Cabinet 17
- Cabinet Selection 17
- Preparing the Cabinet for Installation..... 17
- Check Harness and Wiring 17
- Check Coin mechanisms and Bill Acceptor 17
- Check Coin Door Connections..... 18
- Check High-Definition Television 18
- Remove Existing Card Reader (If applicable)..... 18
- CUT Hole for Card Reader 18

Vacuum Cabinet.....	18
Electronics Installation.....	19
Install Card Reader.....	19
Install Nighthawk SYSTEM Box.....	19
Install Cabinet Identification Device (CID).....	19
Install I/O Board.....	20
Install Antenna.....	20
Trackball and Button Preparation (For Most Kits).....	21
Control Panel Overlay Installation.....	22
Finishing The Control Panel.....	23
Complete System Box Connections.....	24
Attach I/O Power, Audio and USB cables.....	24
Attach Main Video Cable.....	24
Attach Power Cable.....	24
Complete I/O Board Connections.....	25
Connect Input/Output Connection Cable to I/O Board.....	25
Connect the Control Panel Switches and Cable.....	25
Connect New Buttons.....	25
Connect Coin Door Lamps.....	25
Connect the Trackball.....	25
Connect Antenna.....	25
Connect Audio Cables.....	25
Connect the USB Cable.....	25
Connect High-Definition Television.....	25
Connect I/O Power Cable.....	25
Check All Connections.....	25
Marquee Installation.....	26
Lighted Marquee.....	26
Final Connections.....	27
Coin Doors, Test Switch and Volume Control.....	27
Initial Power-Up.....	27
Golden Tee LIVE System Setup Menus.....	28
System Setup Menus.....	28
Main Menu.....	28
Collections & Earnings Menu.....	29
Do Collection.....	29
General Settings.....	30
Operator Adjustables.....	31
General Adjustments.....	31
Money Slot Adjustments.....	32
Sound Adjustments.....	32
Collection Settings.....	33
Reset to Factory Settings.....	34
System Tests.....	35
Video Tests.....	35
Color Test.....	36
Contrast Test.....	36
Screen Size Adjustment.....	37
Sound Tests.....	37
Player Control Tests.....	38
Mechanical Meter Test.....	38
Hardware Tests.....	38
Hardware/Software.....	39
System Info.....	39
USB Info.....	39
Version Info.....	40
Check Hard Drive.....	40
Check Cooling.....	40
Check Card Reader.....	41
Troubleshooting Shortcuts.....	41
Golden Tee Settings & Audits.....	42

Golden Tee Settings	42
Golden Tee Audits	44
Player Cost Schedule	45
Fixed Player Costs	46
Reset Leaderboards & Records	46
ITNet Settings	47
Register Game	47
Change Location	47
Communication Settings	48
Configure Ethernet Settings	48
Configure Wi-Fi Settings	49
GOLDEN TEE LIVE TROUBLESHOOTING GUIDE & REFERENCE	50
Appendix A Troubleshooting Guide	50
Appendix B Input/Output Connections (I/O Power, Trackball, etc.)	57
Appendix C Replacement Part Numbers	58
Appendix D System diagrams	60
Appendix E GNU General Public License	65
Appendix F Informational Guides	67
Wireless Signal Strength and Antenna Guide	67
Collections Guide	68
Income Split Guide	69
Player Wallet Guide	70
Golden Tee LIVE Revenue Guide	71
Accounting for the Various Revenue Types	71
Golden Tee LIVE Fees	72
Accounting for Fees	73
Collections	73
GT LIVE Collection Procedure	75
Menu Navigation Shortcuts	78
APPENDIX G	79
IT NET RULES AND REGISTRATI/ON FORMS	79
ITNet DEBIT ACCOUNT FORM	81
ITNet GAME REGISTRATION FORM	83
ITNet™ OPERATOR AGREEMENT	85
IRS Form W-9	89
Appendix H Mounting Templates	93
Trackball Orientation Diagram	93
Trackball Mounting Template	95
Button Templates	97
Card Reader Mounting Template A	101
Fan Hole Template	105

NOTE
PLEASE RETAIN ORIGINAL SHIPPING BOX FOR SERVICE AND REPAIR.

This kit does NOT include a JAMMA wiring harness and does not use any type of JAMMA connection.

To wire the cabinet correctly please refer to the Input/Output Connections pin out charts in Appendix B and the wiring diagram in Appendix D.

Please be aware that with kit installations it is no longer possible to use any monitor with a resolution below 1280 x 720 (720p).

Do NOT install this kit when the cabinet is powered on. Make sure the cabinet is unplugged from all power sources before and during installation.

Some game features will not be available if the unit is not properly registered to ITNet.

If you REMOVE any online games from your route, even temporarily, please fax in an updated ITNet Game Registration Form (Appendix G) to 847-870-0120 and check the UNREGISTER box. This will remove the game from the online Find a Game app so players are not disappointed when visiting that location.

Please do not forget to UNREGISTER any games you sell and remind the buyer to re-register the game with their own Operator Account. Remember, you are liable for ANY ITNet Fees incurred by a game registered to your account.

Incredible Technologies cabinets are shipped with the USB cables disconnected from the I/O Board and the Cabinet Identification Device (CID). This prevents vibrations during shipment from damaging the contacts on the connectors. These cables must be connected before operating the equipment.

IT recommends disconnecting these USB cables whenever transporting the unit.

SHOWPIECE CABINET

Showpiece Cabinet Contents

(1) Golden Tee LIVE Showpiece Cabinet

Shipped inside a plastic parts bag attached to the front of the cabinet:

- (1) Marquee Header
- (1) Power Cord
- (1) Game Manual
- (1) HDMI Cable

Shipped inside the cardboard sleeve on the top of the control panel:

- (2) Marquee Header Brackets

NOT Included with your Showpiece Cabinet

You will need to supply a digital display for the game's main monitor, and an appropriate stand or wall mount. Incredible Technologies recommends at least a 55" HDTV that supports 1920x1080 (1080p) for the best presentation, game play and earnings potential. A list of Recommended Mounting Solutions can be found under Purchasing Info and Specs at the following address on the IT web site:

<https://amusement.itsgames.com/games/golden-tee-live/specs>

LEG LEVELER ADJUSTMENT

Once your game is in position at the location, it is necessary to adjust the leg levelers. The leg levelers will help stabilize the game on an uneven floor, and help it from moving or shifting during game play. The game is shipped with the two front and two rear leg levelers installed. Adjust the levelers as necessary to level and stabilize the game.

MOUNT MAIN SCREEN DISPLAY

Position the Showpiece cabinet in front of an HDTV. Incredible Technologies recommends either a 720p or 1080p flat panel HDTV from 55" or larger.

The HDTV is intended for use with the Showpiece Integrated Stand (Model 304S) but can also be mounted to a wall. Be sure that the top of the Showpiece cabinet has at least 24" clearance in all directions. Insufficient clearance may result in damage to your display or player injury. Recommended height for your display may vary depending on your location and player base. As a general rule, the minimum height of the bottom of the display viewing area should be 42" from the floor.

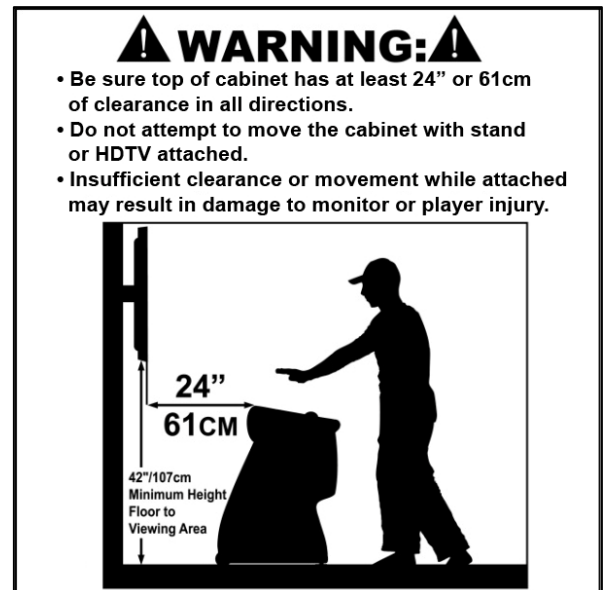

INSTALL MARQUEE

Your Showpiece cabinet comes with a framed marquee header that can be easily attached to the top of your monitor. The brackets for the header are shipped inside a separate cardboard insert labeled *Parts – Do Not Discard* within the cabinet packaging. The insert is located on the top of the control panel.

First, attach the two brackets to the back of the universal mounting plate you are using for your HD display. The brackets share the same screws used to affix the display to the mounting plate, and are sandwiched between the plate and the back of the monitor. Once the brackets are in place, slide the marquee frame onto the clips on the two newly mounted brackets. Be sure the tab on the clips rest inside the channel on the marquee frame.

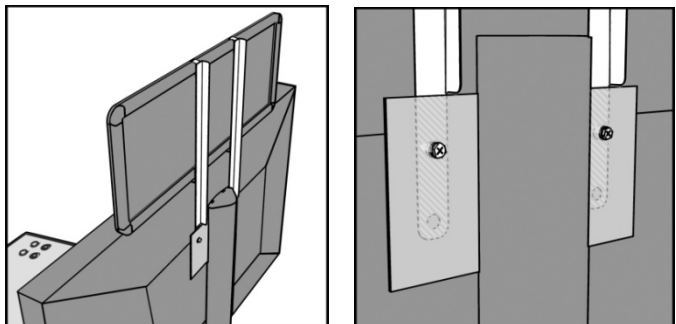

HDTV DIP SWITCH SETTINGS AND NIGHTHAWK SYSTEM BOX

Before making any Nighthawk connections, make sure the USB cables are connected for the I/O Board, CID and Card Reader. See Complete System Box Connections for details.

Nighthawk System Box

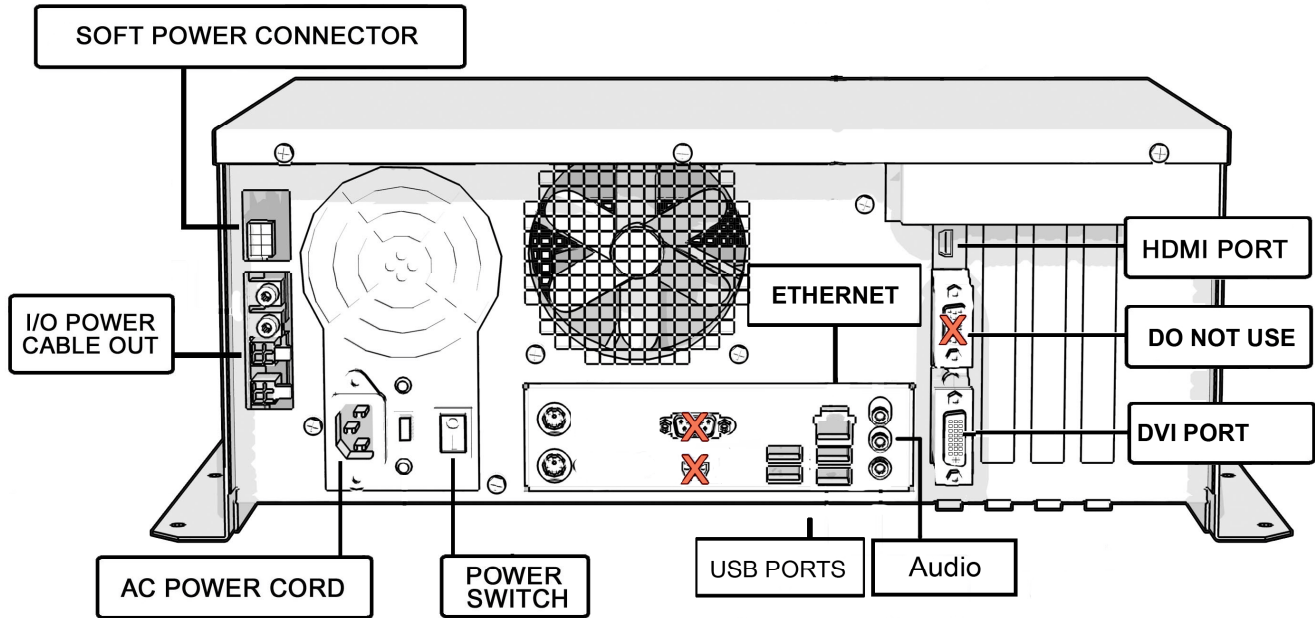

DIP Switch Settings for HDTVs

The DIP switch settings in your Showpiece cabinet have been factory set to accommodate a 1080p HDTV connected through HDMI cables. DIP switch bank Sw201 on the I/O Board controls the video resolution for the main monitor. If using a DVI-D connection, or for different resolutions such as 720p, use this chart:

RESOLUTION SETTINGS		ADDITIONAL SETTINGS	
<p>1280 x 720 (HDMI) 720p</p> <p>1280 x 720 (DVI-D) 720p</p> <p>1920 x 1080 (HDMI) 1080p DEFAULT</p> <p>NOTE: 1080p only available for Golden Tee GOLF/LIVE. All other games default to 720p HDMI.</p>		<p>Primary Monitor</p> <p>Primary Monitor has 16 x 9 Aspect Ratio DEFAULT</p> <p>System Setup</p> <p>Enter System Setup Menu</p> <p>Exit System Setup Menu DEFAULT</p> <p>NOTE: To Enter System Setup menus, ONLY switch DIP 4 ON.</p>	

Notes:

A reboot is required when changing resolutions
 Video and audio connections to HDTVs vary, and may require additional cables not included with the Showpiece cabinet. Also, some displays may not support the resolution needed for your game. Check your display's manual for additional information.

VIDEO CONNECTIONS FOR HDTV

Golden Tee LIVE 2021 supports: 1920x1080 (1080p) and 1280x720 (720p) resolutions. Be sure your HDTV is compatible. 1080p is only available on the approved video cards listed on the Video Card Compatibility sheet included with your game.

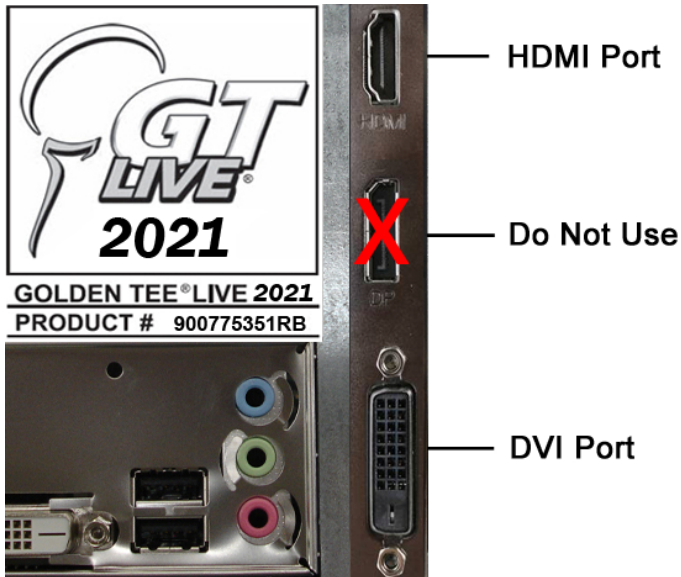

Connect to HDMI

Connect the HDMI cable (supplied) to the HDMI output on the Nighthawk system. Route the cable through the clip under the lock on the back wall, and down through the access panel on the back of the cabinet. Connect the other end of the HDMI cable to the proper HDMI input on your television.

Set Up Your HDTV

Refer to the HDTV manual to adjust the video signal to match the correct input for your game. Selecting the correct input is commonly found from a system menu accessed from the remote, or an Input Select button on the HDTV.

Audio Connections for HDMI

The HDMI cable will also supply audio to the speakers on your HDTV. See Audio/Video Connections Table below for details on other connection types.

Audio/Video Connections Table

Video Mode	Primary Video Connector	Audio
1920x1080 (HDMI) 1080p	HDMI with HDMI Cable	Digital – Via HDMI cable
1280x720 (HDMI) 720p	HDMI with HDMI Cable	Digital – Via HDMI cable
1280x720 (DVI) 720p	DVI to HDMI Cable	Analog – Via Green Audio Jack

FINAL CHECK

APPLY POWER

Connect the power cable to the socket on the back of the cabinet. Then plug the cable into a 3-pronged, grounded wall socket. Locate the power switch on the back of the cabinet and turn it ON.

Note: If the supply cord is damaged, it must be replaced by a special cord or assembly available from the manufacturer or its service agent.

Watch the game carefully when you first turn it on. Look and smell for smoke. Turn it OFF immediately if there is smoke. Make sure the fan inside the system box is running and the LEDs on the I/O Board are flashing. If not, something is wrong, turn off the game.

Check the Cabinet ID Device (CID) Number

Watch the screen during boot-up and wait for the Golden Tee boot verification screen to appear. Note the Cabinet ID Number (CID) that appears on this screen, and verify that it matches the CID number printed on the back of the cabinet. The screen will automatically time out and boot-up will continue.

Check the Coin Switch and Bill Validator

Try the coin switch. Drop quarters or tokens through to check the coin mechanism. Insert a dollar bill into the bill validator and listen for the credits to ring up. Make sure the game is adding credits and the correct quantity. You can use the Player Control Test by pressing the System Setup button inside the coin door and entering the *System Tests Menu*. Make sure all of the controls work.

Checking the Wireless Connection Signal Strength

There are two ways to check the signal strength of your wireless connection. First, you can power the game off and on. A signal meter will appear in the lower right corner of the game's boot-up screen. The number of bars that are displayed indicate the signal strength. Additionally, you can enter Operator Mode by pressing the System Setup button inside the coin vault door. Once at the main Operator Mode menu, use the trackball and Start button to select *ITNet Settings*, then *Communication Settings* to view more information.



Cabinet Temperature

The state of the art Nighthawk hardware is extremely powerful, and therefore generates a substantial amount of heat. Measures have been taken to keep the various components cool during normal use. If overheating occurs, game play and hardware longevity may be affected. Use the Check Cooling menu in the System Setup menus to monitor the temperature within your cabinet. Enter System Setup by pressing the System Setup button inside the outer door of the coin vault. Once at the main System Setup menu, use the trackball and Start button to select *Troubleshooting Shortcuts*, then *Check Cooling*.



Custom Adjustments

Upon initial power-up, the game will initialize to factory default settings. These settings affect game elements such as number of credits per coin, volume settings, etc. The System Setup section in your game manual will describe how to alter these settings and view the system audits or run system tests.

GENERAL CABINET MAINTENANCE

Games that are in good working condition, with clear monitors, clean control panels and working trackballs will make more money than a machine in poor condition. It is definitely worth your time and attention to protect your investment with a little common care. Each week, clean the display and wipe down the control panel to bring back that new game look. Test the trackball and buttons regularly to make sure they are playing properly. And perhaps most important, make sure the coin mechanisms and bill acceptors are in good working order.

CARE AND CLEANING OF RUBBER BUMPER

The rubber bumper on the front of the cabinet's control panel is made from durable nitrile rubber. Clean it using a mild soap and water solution or blue window cleaner.

NIGHTHAWK AIR FILTER

The Nighthawk System Box comes equipped with an external electrostatic air filter. This filter is held in place by a metal bracket, attached to the system box. The filter prevents debris from entering the system box and damaging the electronic components. A clogged filter will impede airflow, thus building up unwanted heat which can cause damage to your hardware. Be sure to check this filter at least once a month. Remove the filter by sliding it out of its housing. Shake off excess dirt and if necessary clean it with soap and water. Be sure the filter is completely dry before reinstalling the filter.

TRACKBALL MAINTENANCE

The trackball will require periodic maintenance to assure optimum performance. In most cases the inside of the trackball simply needs to be cleaned of any accumulated dust and debris. See page 12 for Trackball Replacement.

To access the inside of the trackball, remove the 6 Phillips head screws that hold the trackball together and remove the top cover. Clean out any dust and debris inside the trackball. Polish the rollers and remove any foreign material that may be on the rollers. Do not lubricate the bearings, as this will only attract more dust. If the bearings do not spin freely it is best to replace the bearing assembly. Inspect the rollers for any nicks that may cause poor performance and replace if needed. Inspect the ball for any nicks and replace if needed. Parts can be obtained from Happ Controls and is an economical option rather than replacing the entire trackball assembly.

It is critical that the green field ground wire be properly connected to field ground. This prevents the trackball from building a static charge that can cause the game to lock up or reset. A static discharge can also damage the trackball's electronic components, as well as the main system.

CARE AND CLEANING OF COOLING FANS AND VENTS

The hardware that runs Golden Tee LIVE is quite sophisticated, and many of the chips and processors will get hot very quickly. Like your desktop PC, the Golden Tee LIVE hardware needs adequate ventilation to work properly. Dust and dirt can be a major cause to overheating and will lead to costly repairs. At least once a month, check to make sure the cabinet and system box fans are working and free of dust and debris. Use a vacuum to clear all the ventilation holes on the cabinet at this time as well.

CAUTION:

Incredible Technologies cabinets are shipped with the USB cables disconnected from the I/O Board and the Cabinet Identification Device (CID). This prevents vibrations during shipment from damaging the contacts on the connectors. These cables must be connected before operating the equipment.

IT recommends disconnecting these USB cables whenever transporting the unit.

SHOWPIECE CABINET UPDATE & REPAIR PROCEDURES

KEYPAD

Players use the Keypad to identify themselves for live events. It is attached to the right rear side of the cabinet. For details on installing the Keypad, see the Keypad Installation Guide under Golden Tee LIVE 2021 on the IT web site: <http://amusement.itsgames.com/service/manuals>

SYSTEM BOX

The Nighthawk System Box houses most of the game electronics and hardware in one box that can be easily installed. As with all electronic equipment, the system box should be handled with extreme care. Shock, severe temperature, or sudden impacts can damage the internal components that require costly repair.

Note: Turn off power to the cabinet and remove the power cord from the back of the cabinet when performing any of the following.

System Box Removal

1. Unlock the control panel and open to expose the Nighthawk system box.
2. Disconnect all connections to the system box. Be sure all wires and connectors are clear and out of the way. Label the connectors for easy reconnection.
3. Loosen the 6 ¼" hex-head screws that secure the system box.
4. Carefully lift the system box off the screws and up out of the cabinet.

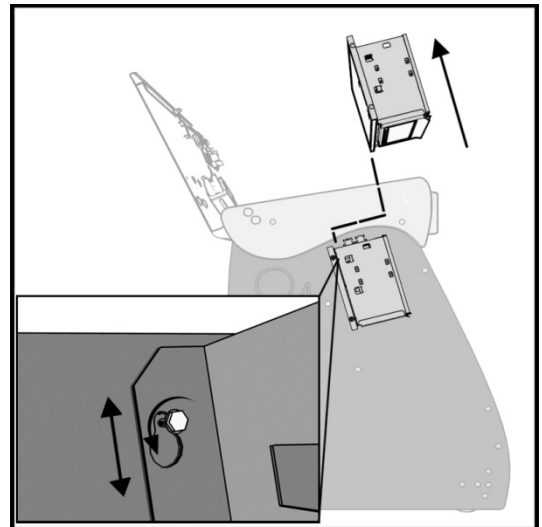

System Box Installation

1. Unlock the control panel and open to expose the inside of the cabinet.
2. Align the system box onto the 6 mounting screws of the internal slanted panel. The connection ports face up. Once the system box is in place, tighten the 6 ¼" hex-head screws to secure the box to the panel.
3. Connect the required connections. See the Connections Diagram for more details.

I/O BOARD

Note: The I/O Board is game title specific and is not interchangeable with other game titles produced by Incredible Technologies on this system. Dedicated and Retrofit Kit I/O Boards are different and are not interchangeable.

I/O Board Removal

First, unlock the control panel and open to expose the interior of the Showpiece cabinet. Disconnect all connections from the I/O Board. Label the connectors for easy reconnection and move them safely out of the way. Next, remove the six ¼" wood screws that secure the board to the interior left side of the cabinet (as you face the game). Carefully remove the I/O Board from the cabinet.

I/O Board Installation

Place the I/O Board in the proper location on the interior left side of the cabinet (as you face the control panel of the game). Be sure it is oriented properly so the cables reach the board (the USB port on the I/O Board facing the top of the cabinet). Secure the I/O Board to the side of the cabinet with the six ¼" wood screws. Use the factory mounting holes if at all possible. Be sure the board does not "bow" or is not stressed in any way. Once mounted, connect the appropriate connections.

Cabinet Identification Device (CID)

This device contains a specific ID number that identifies your cabinet. The CID is a permanent number and must be connected to the main system box via the USB cable and working properly in order for the game to operate.

CID Removal and Replacement

If for some reason you must replace the CID, disconnect the USB cable from the CID. This is the only connection to the CID. Next, remove the four ¼" wood screws that secure the CID to the interior left side of the cabinet (as you face the game). The CID is located above the I/O Board. To install a CID, mount the CID in the proper location using four ¼" wood screws. The CID should be mounted so the USB port is facing the top of the cabinet and the electronics are facing the wall.

Note: The Cabinet Identification Device should NEVER be removed from the cabinet, even when replacing any of the other components. The CID is the cabinet's PERMANENT Identifier, regardless of any other components.

CASH VAULT

The Cash Vault has been designed for optimal security. With the double-locking doors, service technicians can read meters and enter System Setup mode with no access to the cash box.

Cash Vault Removal and Replacement

- 1) Unlock and open the outer door of the Cash Vault.
- 2) Using a T-15 Torx wrench, unscrew the card reader/button plate located on the right side by removing the four #8-32 screws located at the top and bottom of the plate.
- 3) Unplug the cable from the card reader, and disconnect the connectors for the coin meter and buttons.
- 4) Remove the plate and set it aside.
- 5) Remove the coin bin and the bill validator magazine to make it easier to work inside the vault.
- 6) Unplug the bill validator cables, and push the cables for the bill validator, card reader, buttons, and coin meter through the 2 holes located in the back of the vault.
- 7) The Cash Vault is attached by upper and lower locking brackets. These are each attached with two socket-head screws located within the vault.
- 8) Locate the socket-head screws on the top and bottom locking brackets. Remove the two bottom screws using a 9/64" hex key and remove the bottom locking bracket. Make sure to note how it was installed.
- 9) Remove the two top screws and remove the top locking bracket, again noting how it was installed.
- 10) You can now pull the entire vault assembly out from the front of the cabinet. The vault is attached with foam tape, so it will need to be pried out or pushed from behind to loosen the adhesive.
- 11) Reverse the procedure to install the new vault.

Locks

The outer lock is a secure T-handle lock, commonly used in vending. To open, insert the key and turn it clockwise until the lock-handle pops out. Next, rotate the lock-handle clockwise 90 degrees to open the outer door.

The inner door has a lock installed above the System Setup button. This lock is unlocked by turning the key 90 degrees clockwise.

Volume and Service Buttons

Mounted inside the outer door are controls for Volume and System Setup. Press the Volume Up button to increase the loudness of the sounds on the game, and press the Volume Down button to make your game quieter. Press the System Setup button to access the game's software menu system. The System Setup menus cover a variety of important areas including collections, tests, game adjustments, and optional settings.

Bill Acceptor

The dedicated cabinet ships with a MARS AE2681 D5 bill acceptor and is mounted on the cash vault door. The default dipswitch settings for this acceptor are ON = 1,2,4-7 and OFF = 3,8.

Bill Acceptor Removal

Disconnect the cable to the bill acceptor. Remove the four 11/32" sized nuts from the mounting studs. Disconnect the ground wire from the one lower stud. Then gently pull the acceptor off the studs from the back side of the coin door.

Bill Acceptor Installation

From the back side of the coin door, place the bill acceptor onto the four mounting studs. The faceplate will protrude out the front of the coin door. Place the field ground wire on a lower stud, and install the four 11/32" sized nuts on the mounting studs and tighten. Next, connect the bill acceptor cable in the cabinet to the mating cable on the bill acceptor itself.

Stacker Removal

A blue slide switch is located at the bottom of the stacker. Engaging it allows the stacker to be removed.

Coin Mechanism Removal

Loosen the two finger screws to release the securing braces. Slide the upper brace upward, and the lower brace downward. The mechanism should pull straight out.

Meter

This 5-volt device is mounted behind the card reader plate next to the inner door of the coin vault. One lead of the meter is connected to a +5 volt source and the other lead is connected to the appropriate signal wire. An additional opening is available just below the meter, if a second meter is desired.

CONTROL PANEL

Opening the control panel provides access to all game controls and hardware components. To open the control panel, simply use the supplied key in the lock on the back of the cabinet and lift from the back. The control panel is hinged in front and will stay open when fully extended.

Soft Power Switch

A "soft power" switch has been added to the underside of the control panel, to assist in the update process. This switch will turn off power to the Nighthawk system box so you don't have to reach around to the main power switch located on the back of the cabinet.

Note: If you turn power off using the Soft Power Switch, you must use this same switch when turning power back on.

Trackball Replacement

To replace a trackball, open the control panel and remove the 4 long screws holding the trackball in place. Be careful not to lose any of the screws, washers and lock washers. Disconnect the wire harness and ground wire and remove the old trackball. Position the new trackball in the proper orientation over the existing standoffs. Make sure that the arrow on the trackball that points to the monitor is pointing up. Replace the 4 long screws and washers. Do not over tighten! Screw in until the lock washer is fully compressed. Reconnect the wiring connector and ground wire.

Note: The field ground wire is critical to avoid electrical problems and assure optimal performance.

Button Replacement

All of the buttons on the control panel require a 1 1/8th inch hole, and are pre-drilled on the dedicated control panel. To remove a button, disconnect the wires from the button assembly by sliding the wires off of the micro switch posts. Next carefully twist the micro-switch assembly off of the button posts. Finally, unscrew the nut to remove the button from the control panel.

Place the new button assembly into the hole and position the smaller side of the micro-switch housing to face the rubber bumper, angled towards the middle. Tighten the supplied nut using a pushbutton wrench. Do not over tighten. Install the micro-switch by snapping it onto the pushbutton assembly by hand. Position the assembly so the micro switch posts face the rubber bumper, angling towards the middle. Reconnect the wires by sliding the wire assembly onto the contact posts of the appropriate micro switch. See the wiring diagram in Appendix D.

Control Panel Removal

To remove the control panel from its hinge, Disconnect the trackball cable, field-ground wire, and the control panel interconnect connector to the I/O Board. Remove the screw that attaches the safety cable to the control panel. Remove the four 1/4" screws holding the panel to the hinge.

Control Panel Graphics Removal

The control panel artwork has been screened onto a solid sheet of polycarbonate, which is resistant to scratches and burns. Unfortunately long exposure to excessive situations may damage the surface over time. To remove and replace this piece, the pushbutton and trackball assemblies must first be removed. Separate the polycarbonate piece from the wood portion of the panel by starting at one corner and slowly peeling the two apart. The overlay has adhesive on the entire surface and will take some force to separate the pieces due to the adhesive. Once removed, the graphic overlay will not be able to be used again.

Control Panel Graphics Installation

To install a new polycarbonate graphics overlay, make sure the wood control panel surface is clean, smooth, and free from glue, dirt and debris. Remove the paper protecting the adhesive from the new artwork/cover panel. Carefully place it on the wood panel, aligning it properly. Press and smooth firmly to assure that it is secure. Replace the buttons and trackball in the correct orientation.

ANTENNA

The antenna connects to the I/O Board and is housed under the control panel mounted to the left side of the back panel. A strong wireless signal is very important to getting the most out of your game. Depending on the positioning of the game in the location, you may need to adjust the antenna's position to achieve the best signal. See the Wireless Signal Strength and Antenna Guide found in the accompanying game manual for more information on getting the best possible wireless signal strength for your game.

CARD READER

The Card Reader is a very important aspect to Golden Tee LIVE, and is very important to keep in good working condition. Players are required to use a card to identify themselves for most of the online features. If the card reader is not working properly, these features will not be available.

Card Reader Removal

Access the card reader through the coin door opening. To remove the card reader, disconnect the USB connector from the Card Reader. Then remove the 4 T-15 security screws that secure the mounting panel that holds the card reader, coin counter and buttons. Next, remove the two Phillips head screws holding the card reader to the mounting panel. Once loose, pull the card reader out through the front of the panel.

Card Reader Installation

Open the coin door to access the card reader mounting. Place the back end of the card reader through the opening on the mounting panel. The larger portion of the card reader bezel should be in the up position. From the backside of the panel, secure the card reader to the panel with the 2 Phillips head screws. Once in place, reconnect the USB cable to the card reader. Attach the mounting panel to the coin door with the 4 T-15 security screws. Power the game back on and test the card reader using the Card Reader Test located in the Troubleshooting Shortcuts Menu in System Setup.

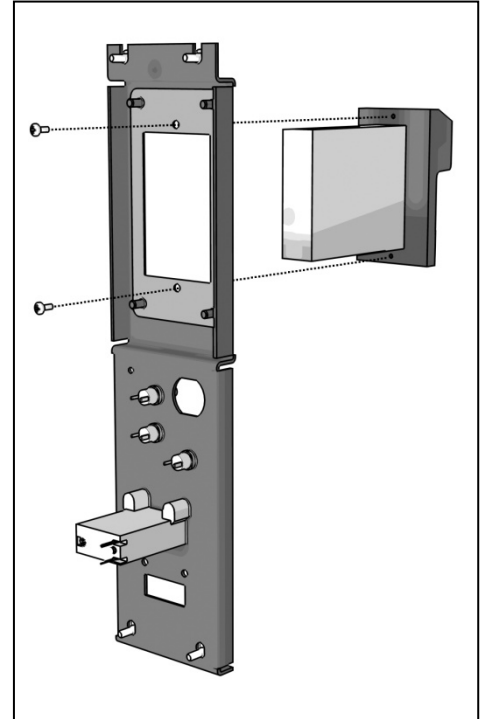

KEYPAD

If you have an online subscription, you and your friends will need to check in each time you play, so your stats and achievements are tracked and stored. It's important to always check in with the same ID each time, so your profile and stats are accessible. For details on installing the Keypad, see the Keypad Installation Guide under Golden Tee LIVE on the IT web site: <https://amusement.itsgames.com/service/manuals>

No Player Cards Needed!

Now instead of swiping a card to check in, simply type in your 10-digit "Cardless ID" and 4-digit PIN to access your personal online profile. There's no need to wait for a card in the mail or worry about losing them. Just type in your number and play!

Setting Up a Cardless ID

If you have already set up a web account, you can log in and add a Cardless ID to your profile. Log in to your web account on goldentee.com or the GT Caddy app, then go to the Account section. If you already use a card to check in but have not attached it to a web account, go to goldentee.com and click REGISTER. Then click "I play with a player card, credit card or cardless ID". Follow the prompts to create your web account, verify your email address, and add a Cardless ID. If you have never played online, you will need to first register for a web account. Go to <https://www.goldentee.com> and click REGISTER. Then click on "I have not played with an ID card yet but would like to". Follow the prompts to create your web account, verify your email address, and add a Cardless ID.

Check In and Play!

Once your Cardless ID has been added to your web account, you can check in each time you play online. Press Start to begin a game, select the number of players and the online game type you want to play, and type in your Cardless ID and PIN when prompted.



ONLINE KIT CONTENTS

Please refer to the IT part numbers in Appendix C when ordering parts.

- (1) Golden Tee 2021 Nighthawk System Box
- (1) Keypad Box and hardware
- (1) I/O Board Assembly Golden Tee 2021
- (1) Cabinet Identification Device (CID) for Golden Tee 2021
- (1) Trackball cable
- (1) Input/Output Connections Cable
- (1) I/O Power Cable
- (3) 6' USB Cable
- (1) 15' HDMI Cable
- (1) AC Power Cable
- (1) 3" Trackball, White
- (1) Trackball Plate for 3"
- (1) Pushbutton Assy., Red
- (4) Pushbutton Assy., White
- (1) Pushbutton Assy., Blue Round Illuminated
- (1) Pushbutton Assy., Yellow Round Illuminated
- (1) Marquee, Golf LIVE 2021
- (1) Control Panel Graphics Overlay, Golden Tee LIVE
- (1) Your Card is Your I.D. Insert
- (1) Manual, Golden Tee LIVE 2021
- (1) Quick Install Guide Golf LIVE Kit
- (1) Antenna with cable for wireless modem
- (1) Card reader Sub-Assembly w/Bezel and hardware
- (1) Parts bag containing miscellaneous hardware
- (1) *Fully-dressed Control Panel (Includes: assembled trackball, control panel overlay and buttons as a unit)

*There is an additional fee for kits with the fully-dressed control panel. If the fully-dressed control panel was not ordered, the kit includes ONLY: trackball, control panel overlay and loose buttons NOT assembled.

KIT INSTALLATION

RECOMMENDED TOOLS

Have the following tools ready before you begin to install this kit:

- ¼", 11/32" and 7/16" Sockets or Nut Drivers
- Phillips Head #2 Screw Driver
- 3/16", 7/32" and 9/32", or 5/16", 3/8", and ¾" Drill Bits
- 1 1/8" and 3 1/2" Hole Saw or Drill Bit
- Small Flat Blade Screwdriver
- Jig/Sabre Saw
- Router

- Push Button Nut Socket or Large Adjustable Pliers
- X-acto® Knife or other Sharp Knife/Razor Blade
- Wire Cutters
- Scissors
- Tape Measure
- Putty Knife
- Decal Roller/Squeegee
- Liquid Window Cleaner & Cleaning Cloth
- Vacuum Cleaner
- Any tools needed to remove parts from your existing cabinet not listed above.

INSTALLATION PREPARATION

BEFORE YOU START...

Before you install the Golden Tee LIVE kit into your cabinet there are a few things you should check first:

1. Check to make sure your existing cabinet's monitor, speakers, AC power cord, lights, bill acceptor and coin mechanisms work.
 - Replace or repair where necessary.
2. Check to make sure all the necessary parts are included in your kit.
 - If any are missing/damaged please contact IT's Technical Support at 847-870-7027 x121.
3. Check to make sure cabinet is wired with standard earth grounded AC plug compatible with local building codes and/or safety requirements.
 - If not, have a qualified electrician install one (not provided).
4. Have all the necessary tools available to install this kit.
 - Refer to the recommended tools list to make sure you are prepared before you start.
5. Make sure any parts of the system (lights, monitor, etc.) are not plugged in.
 - Working with any part of the system plugged in or powered on can be dangerous.
6. Keep in mind that it's been proven that the higher quality of work put into a kit installation results in a higher earning game.
 - Make sure you have plenty of space, time, and focus to put into this kit installation.

PREPARING THE CABINET

CABINET SELECTION

You can choose either a new cabinet or a used cabinet for your Golden Tee LIVE game. In either case, you will need: Speakers and a HDTV monitor capable of at least 720p resolution. See HDTV DIP Switch Settings and Nighthawk System Box for more details.

PREPARING THE CABINET FOR INSTALLATION

Follow these steps to prepare your cabinet before installation:

1. Remove the following from the cabinet: Main Logic Board(s) (and hard drive if present), Control Panel, Monitor Viewing Glass, Power Supply and JAMMA Cable Harness. The I/O Board in this kit does **not** have a JAMMA connector but instead uses an Input/Output Connections Cable.
2. Thoroughly clean out your cabinet. Replace wiring from the I/O Board with the Input/Output Connections Cable.

CHECK HARNESS AND WIRING

The Golden Tee LIVE Kit can easily interface with any Golden Tee LIVE showpiece cabinet. If your current cabinet is equipped with a standard JAMMA cable, the JAMMA cable assembly will need to be removed and replaced with the Input/Output Connections Cable included with the kit. Make sure your existing wires and connectors are in good working order. Check the pin out chart in Appendix B and the wiring diagram in Appendix D for harness connections.

CHECK COIN MECHANISMS AND BILL ACCEPTOR

Make sure your coin mechanisms and bill acceptor are functioning properly, and your coin box and stacker are in good condition. You want to make sure your game will accept money when players are ready to play.

CHECK COIN DOOR CONNECTIONS

Your cabinet should already be wired correctly to the I/O Board's connectors. Now is a good time to make sure your game can accept money. Check the pinout chart in Appendix B for the correct wire colors and pins. Trace the wiring to their sources and make sure they are connected properly and securely. Be sure the wires are away from the coin door where they can be pinched or crimped.

CHECK HIGH-DEFINITION TELEVISION

Golden Tee LIVE supports a 1080p and 720p resolution that is compatible with newer HDTVs. Televisions with lower resolutions are NOT supported. Refer to the Showpiece section of this manual for details on connecting video and audio to a 1080p or 720p HDTV.

Note: Video and audio connections to these displays vary, and may require additional cables not included in the Golden Tee LIVE kit. In addition, some televisions may not support the resolution needed for Golden Tee LIVE. Check your television's manual for additional information.

WARNING: Be sure top of cabinet has at least 24 inches or 61 centimeters of clearance in all directions. Insufficient clearance may result in damage to monitor or player injury.

REMOVE EXISTING CARD READER (IF APPLICABLE)

Golden Tee LIVE requires a new card reader, to take advantage of new credit card technology. To remove your current card reader, open the coin door to access the card reader. Reach inside and disconnect the ribbon cable from the Card Reader. Then from inside remove the four 11/32" nuts that hold the card reader to the inside of the cabinet. Once loose, pull the card reader out through the front of the cabinet. If you are installing an Offline kit, install the supplied card reader plate to cover this opening.

CUT HOLE FOR CARD READER

If your cabinet does not have a card reader installed, you must cut a hole to mount the supplied card reader. The card reader is a very important aspect to Golden Tee LIVE, and is very important to keep in good working condition. Players are required to use a card to identify themselves for most of the online features. If the card reader is not working properly, these features will not be available.

Position the Card Reader Hole template found in Appendix H on the front of the cabinet, and as high up as possible so players won't have to stoop over to insert their cards. Use an awl to mark the center of the four bolt-holes and drill them to size. Use an electric handsaw to cut the rectangular opening to house the card reader.

VACUUM CABINET

The "new game look" should always apply to the inside of your game as well. A few wire ties and shrink tubing on your harness, some fastening hardware on your subassemblies, and a thorough sweep with the vacuum cleaner will help ensure that glitches do not occur.

Dust and dirt can damage your hardware and cause problems with game play. Be sure that your cabinet is clean inside and out. It is highly recommended to vacuum your cabinet at least once a month, especially near the fans and vents, to avoid overheating and costly repairs.

ELECTRONICS INSTALLATION

INSTALL CARD READER

Place the back end of the card reader through the opening on the cabinet. If there is no opening it is necessary to cut a hole for the card reader. See Appendix H for mounting templates. The large part of the front of the card reader faces up. Insert the four carriage bolts into the mounting holes of the metal bezel. Reach through the coin door to secure the 11/32" nuts to the carriage bolts, and secure the card reader in place. Connect the USB cable to the card reader and feed the rest of the cable to the back of the cabinet. The other end of the cable will connect to the System Box. Power the game back on and test the card reader using the Card Reader Test located in the Troubleshooting Shortcuts Menu in System Setup.

INSTALL NIGHTHAWK SYSTEM BOX

The Nighthawk System Box houses most of the game electronics and hardware into one box that can be easily installed. **Verify that the Nighthawk System Box Power Switch is in the "ON" position.**

1. Locate the area where the system box will be placed. Make sure there is enough clearance to plug in cables. In newer Showpiece cabinets the area is directly below the control panel.
 - ❑ The Nighthawk System Box measures 19" W x 7" H x 11" D. Allow for air to flow into the system box through the filter. Overheating can damage your system.
2. Relocate and secure any wires to make room for the system box.
3. Place the system box so it does not pinch wires.
4. Mount the system box with 6 - #6 x 3/4" Hex Washer Head Sheet Metal Screws.

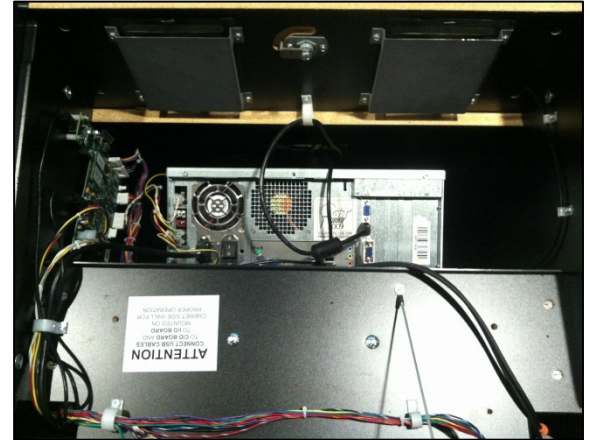

Note: The Nighthawk System Box comes equipped with an external air filter to help keep dust, smoke and debris from collecting on the electronic components. Check and clean this filter regularly to avoid costly repairs.

INSTALL CABINET IDENTIFICATION DEVICE (CID)

The Cabinet Identification Device or C.I.D. is an innovative and important component. This device permanently identifies your cabinet as Golden Tee LIVE. It should remain even if another component such as the I/O Board or system box is replaced. The C.I.D. has a unique number to individualize the cabinet and is referred to as the Cabinet Identification Number.

1. Attach the C.I.D. to the inside side of the cabinet using the 2 - #6 X 1" Hex Washer Head Sheet Metal Screws. Mount so the port is facing up and the electronics face the wall.
2. Attach the USB cable from the system box.
 - ❑ Place the included Cabinet Identification Number on the back of the cabinet for future reference. **Refer to this number to track your equipment and whenever you are calling in for service.**
 - ❑ The Cabinet Identification Number is displayed in the operator menus in the lower right hand corner, and is labeled as Game ID. It is also displayed on the last line of the initial boot-up screen.

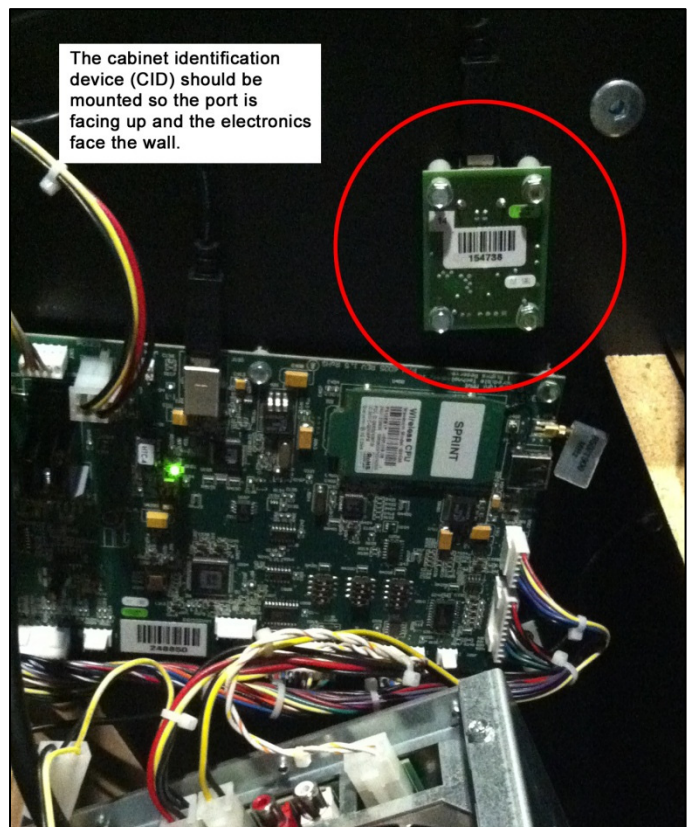

Disconnect all CID USB cables before transport.

INSTALL I/O BOARD

Note: Before installing any electronics, make sure cabinet power switch is in the OFF position and the cabinet power is unplugged from the wall.

The I/O Board is used as a connection interface between the peripherals and the system box.

Mount the I/O Board inside the cabinet using 4 of the 6 x 3/4" Hex Washer Head Sheet Metal Screws, one in each corner. Do not attach cables at this time.

Route all cables AWAY from the I/O Board. Laying cables on top of or below the I/O Board will result in unwanted noise or static during game.

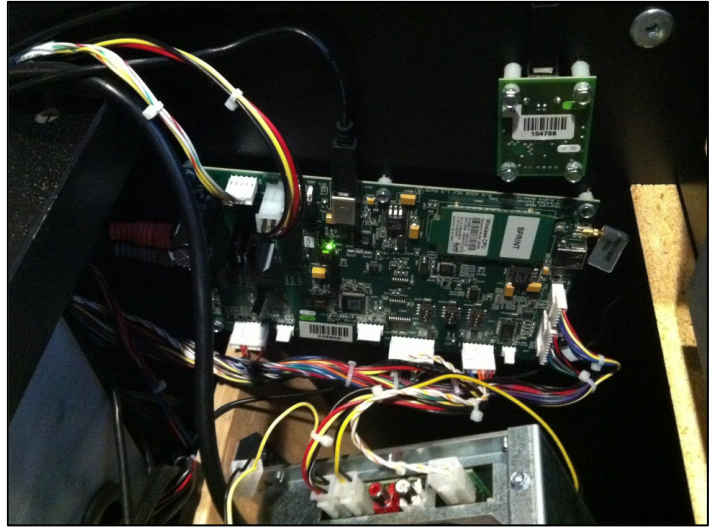

Disconnect all I/O Board USB cables before transport.

INSTALL ANTENNA

Mount the supplied antenna to the upper back of the cabinet. When mounted vertically, the antenna is omnidirectional, so be sure it is as straight as possible to get the widest signal area. **Do not** attach the antenna to metal and keep the antenna away from metal as much as possible.

The cable connector snaps into the I/O Board connector. Be careful as the connection to the I/O Board is a delicate connection. Do not leave any 90-degree bends in the antenna cable. You can wind the excess cable loosely in a loop.

Careful placement of the antenna is important for good wireless communication. Sometimes relocating a wire or moving the antenna within the cabinet will deliver a more reliable signal. Once the installation is complete, be sure to use the Signal Strength test in the game's System Setup menus. Refer to Appendix F for more details on how to achieve the best signal strength.#

Note: Take care not to bundle the antenna wire with other cables in the cabinet.

TRACKBALL AND BUTTON PREPARATION (FOR MOST KITS)

Mounting the trackball and buttons correctly and securely is very important for the profitability and safety of your new game. This kit is designed for use in cabinets with $\frac{3}{4}$ " thick wood control panels where proper routing of the control panel is used to create a safe playing experience. If you do not have a $\frac{3}{4}$ " thick wood control panel, please replace your control panel or choose a cabinet with a $\frac{3}{4}$ " thick wood control panel installed. Keep in mind that if your current control panel has many old holes in it from previous buttons, joysticks, etc. that it may be easier to start with a new solid control panel. This will give your game a better look and feel and help it to earn better.

If the cabinet already has a trackball plate installed, discard and replace with the new trackball plate. The metal trackball mounting plate and trackball mounting procedure have been designed to remove all bolts from the playing surface. Routing the wood control panel is required so the metal mounting plate is flush with the panel surface. An uneven playing surface or exposed edges will affect game play and could impact your earnings.

TIP: Trackball and button templates can be found in Appendix H of this manual. They include:

- Trackball Orientation Diagram to orient your trackball correctly when installing.
- Trackball Template to install the trackball plate and make the appropriate routing.
- Button Set Templates to position and install control panel buttons.

Trackball Preparation

Install the metal trackball plate by following these steps:

1. Cut out the template from Appendix H with a pair of scissors along the noted line. Tape this template to the top of the control panel as far away from the monitor as possible, making sure that the trackball will clear the cabinet beneath it. Remember that installing the trackball as far away from the monitor as possible will prevent players' hands from hitting the monitor glass when rolling the trackball forward.
2. Using a sharp object, mark the eight points shown on the template on the control panel. Using a pencil, trace the outside of the template. Remove the template.
3. Drill Holes 1-4 with a $\frac{9}{32}$ " or $\frac{5}{16}$ " drill bit.
4. Drill Holes 5-8 with a $\frac{3}{4}$ " drill bit.
5. Route the crosshatched region to a depth of about .075" (about the thickness of a nickel).
6. Using a sabre saw cut out the center portion by cutting between holes 5-8.
7. Once you have cleaned up the routed area, install the trackball plate into the control panel using the $\frac{1}{4}$ " Flat Washers and $\frac{1}{4}$ -20 Nylon Hex Nuts. Be sure the mounting plate is flush with the top of the control panel.

Note: At this time you are only installing the trackball plate, do not install the trackball yet.

Button Preparation

The following are the steps you should take to prepare your control panel for the installation of the button assemblies:

1. Cut out the template(s) (see Appendix H).
2. Using a tape measure, measure the specified distances from the center of the trackball hole in the trackball plate and make a mark for both the left and right button reference points.
3. Lay each template over the appropriate reference marking point. Mark the centers of the remaining holes using a sharp object.
4. Drill a $1 \frac{1}{8}$ " hole at each marked point.

CAUTION: Do NOT install the trackball or buttons until the control panel graphics have been applied.

Once the installation is complete, be sure to use the System Controls test in the game's System Setup menus to ensure proper functionality of all the player controls.

CONTROL PANEL OVERLAY INSTALLATION

Golden Tee LIVE comes with an oversized control panel overlay that will accommodate a variety of existing game cabinets. Follow these instructions to correctly install the control panel overlay on one of these cabinets:

1. Make sure that the newly drilled control panel has a smooth, clean surface. Sand where necessary to make sure the graphics are installed on an even surface.
2. Clean the control panel to make sure it is free from dust, grease, metal filings, etc. Make sure that all residues (adhesive, overlay material, etc.) from the previous control panel graphics are removed. This will ensure a clean, easy, and beautiful application of the control panel graphics.
3. **It is very important that the trackball and control panel graphics be mounted perfectly straight.** Find the center of your trackball template and lightly draw vertical and horizontal guidelines on the control panel, marking out your centering lines.
4. Remove a small section of the protective backing from the overlay. Carefully center the overlay over the control panel by lining up the die-cut hole with the trackball template. **Be sure the graphic is positioned perfectly straight.** Line up your pencil guidelines with the lines incorporated into the art. Once in position, gently press down on the section with exposed adhesive, affixing the overlay into place. Once affixed, the overlay cannot be removed.
5. While holding down the overlay over the attached area, very carefully turn over one side and remove the exposed backing. Gently lay down the exposed overlay from the center outward, smoothing with your hands or a roller as you go. **Be sure the overlay remains straight and square.** Repeat the process with the other side of the overlay, so the entire surface is affixed to the control panel. Make sure all bubbles have been pressed out for a clean, flat surface.
TIP: Liquid window cleaner can be sprayed onto the control panel before placing the overlay onto the control panel. The window cleaner will allow the overlay to be positioned with less risk of damage to the overlay or adhesive. Once in position, use a decal roller or squeegee to force any excess cleaner out. Be sure to add additional time for the liquid to evaporate.
6. Using a razor knife (or other sharp instrument) carefully cut around the edges of your control panel, trimming any excess material.
7. Find the center of each hole you have drilled out for the buttons and use the knife to poke a hole into the overlay. Make a vertical and horizontal line (like a plus sign) from the center of the hole to the edges. You should be able to place your button in later with no edges showing.

CAUTION: If you choose to install a Plexiglas® cover over your control panel (not recommended), to ensure the safety of your players and the quality of your game make sure that all surfaces, edges and bolts that a player may come in contact with are smooth, safe and secure.

FINISHING THE CONTROL PANEL

1. Reattach the control panel to your cabinet adjusting any hinges or chains where necessary. Make sure not to pinch or crimp any wires while re-attaching the control panel.
2. Install the trackball into the trackball plate. The trackball must be oriented correctly in order to function properly. Refer to the diagram located in Appendix H for correct orientation. You will need the following parts in order to install the trackball correctly to the plate: 4 - 10/32 x 2½" Phillips Head Machine Screws, 4 - #10 Flat Washers and 4 - #10 Split Lock Washers **NOTE:** Do not over-tighten the trackball. It will warp and cause the trackball to not operate correctly.

IMPORTANT! Be sure to install your trackball securely, and maintain it regularly. Loose, worn, or incorrectly mounted trackballs can result in decreased earnings and possible injury to players.

3. Secure the trackball ground wire to the trackball plate at the 8-32 stud on one end with an 8-32 KEPS nut and the other end to the cabinet ground stud (usually located near the AC power cord inlet) using an 8-32 KEPS nut.
4. Install the buttons in the holes located on your control panel. Make sure you use the red button assembly for the Start button, the lighted blue button assembly for the Help button, and the lighted yellow button assembly for the Options button.
5. Attach the micro switches to your newly installed buttons and connect the wires up to the correct pins on the Input/Output Connections Cable.

Note: The post on the switch labeled COM should connect to the ground wire and the post labeled NO should connect to the signal wire. See the pin out chart in Appendix B.



CAUTION: Trackball and trackball plate **MUST BE GROUNDED** to Earth Ground to prevent damage to the trackball or game electronics.

COMPLETE SYSTEM BOX CONNECTIONS

Follow these procedures to correctly connect the various electronic components. Be sure the cables are connected securely and in working order. Use cable clamps, with appropriate tension, where necessary to ensure all cables stay in place during operation. Dress all cables with additional clamps and wire tie wraps where needed. Avoid loose wires or disconnected cables, as they can cause an unneeded service call.

ATTACH I/O POWER, AUDIO AND USB CABLES

- ◆ **I/O Board power cable.** Connect from the I/O Board to one of the two 4-pin power output connectors on the system box.
- ◆ **USB cable #1.** Connect from the I/O Board to any USB port on the system box.
- ◆ **USB cable #2** for Cabinet Identification Device (CID). Attach to any USB port on the system box. Refer to the CID Installation Section for proper orientation and placement of the CID.
- ◆ **USB cable #3** for Card Reader. Connect to any USB port on the system box. Connect the other end to the card reader.

ATTACH MAIN VIDEO CABLE

HDMI to HDMI is the default connection. It is also possible to connect using the DVI port.

Be sure to adjust your DIP Switch settings to match your monitor's resolution. Refer to the Quick Install guide included with your game.

ATTACH POWER CABLE

Use the AC power cord that is currently in your cabinet. The cord plugs into the system box. Have a qualified electrician do the wiring. Verify AC main voltage selector switch is in the proper position. In North America the setting is 115 volts AC. In some countries this should be set at 230 VAC.

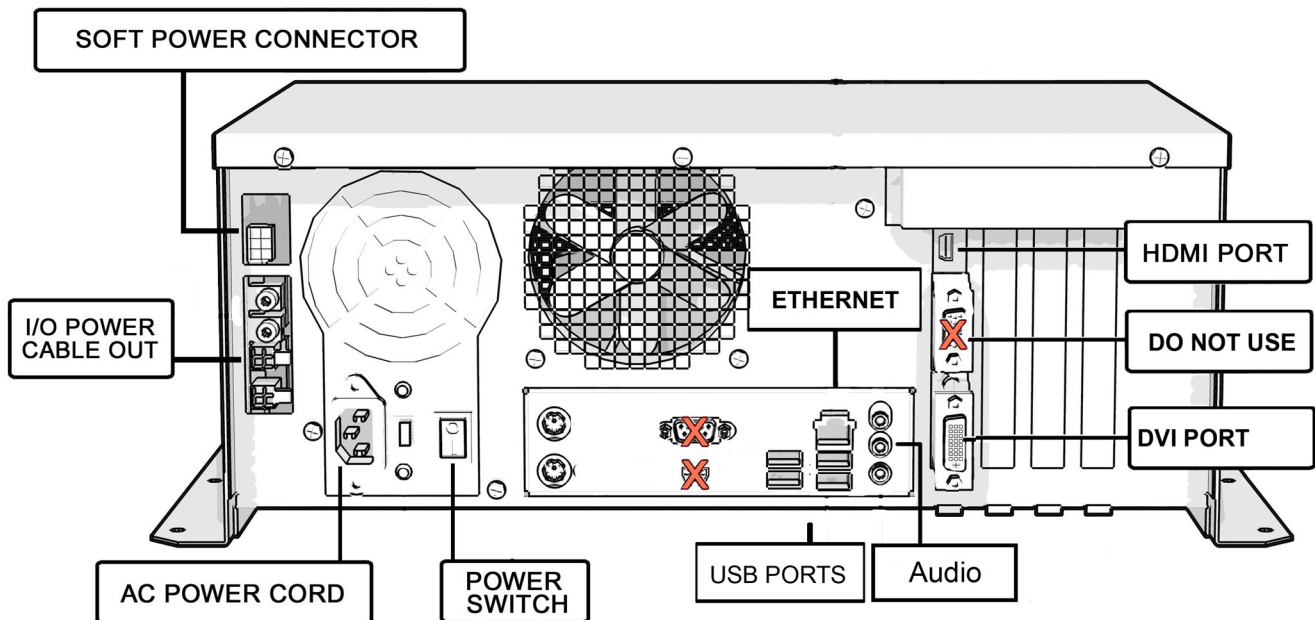

COMPLETE I/O BOARD CONNECTIONS

CONNECT INPUT/OUTPUT CONNECTION CABLE TO I/O BOARD

Connect the Input/Output Connection Cable to the I/O Board connectors (Appendix B). Be sure it has a tight fit and is correctly oriented. The size of the connectors should match the size of the connectors on the cable.

Note: The Speaker (J301) wires and service panel wires must terminate to match your application.

CONNECT THE CONTROL PANEL SWITCHES AND CABLE

Snap the switches onto the buttons. Connect the Control Panel wiring harness using the pin out chart in Appendix B.

CONNECT NEW BUTTONS

Golden Tee LIVE has two additional buttons, Help and Options. Locate the cable from the control panel and connect it to the connectors labeled Control Panel and Lamps on the I/O Board.

CONNECT COIN DOOR LAMPS

Connect the coin door lamp cable to the pigtail off the I/O Power cable. If your game had a GT Fore! green PCB, then use the 9 pin connector. If your game had a GT Fore! red PCB, then use the 4 pin connector. Find the mating connector leading to the coin door to make your connection.

CONNECT THE TRACKBALL

Locate the Trackball Cable and connect it to the connector labeled Trackball on the I/O Board. The other end will connect to the trackball. Connect the green earth ground wire to the trackball plate.

CONNECT ANTENNA

Locate the antenna cable and attach to the connector on the I/O Board. A click should be heard if installed properly. Be sure the antenna is mounted vertically to achieve the widest signal.

Note: Use extreme care with this connector, as it is very delicate and can be easily damaged.

CONNECT AUDIO CABLES

Audio Cables are not included. This method is only needed if using Analog Video 720P resolution. Connect a 3.5mm audio cable to the green audio jack on the system box. The other end of the cable will connect to the TV analog Audio input. If the TV Audio input is an RCA input jack the appropriate cable or adapter will need to be used.

CONNECT THE USB CABLE

Locate the 6 ft. USB Cable from the Nighthawk System Box and connect it to the USB port on the I/O Board.

CONNECT HIGH-DEFINITION TELEVISION

Golden Tee LIVE supports HDTV monitors with resolutions of 1280x720 and above (DVI-D and HDMI). HDTVs can be connected to the system box using HDMI to HDMI and DVI to HDMI connections. Refer to the diagrams in Appendix D for the proper connection for your television. Be sure to set the Video DIP Switches on the I/O Board to match your resolution. HDMI to HDMI is recommended.

CONNECT I/O POWER CABLE

Connect the I/O Power cable to the power input connector. Use the end with the pigtail. The other end connects to the system box.

CHECK ALL CONNECTIONS

Go over your entire cabinet again and double-check all of the connections. Make sure that all connectors are tight and secure and in their proper place. Look for frayed, broken or exposed wiring and repair as needed. Bundle and wire-tie your wiring and secure it to the inside of the cabinet. A thorough and neat job now will save you a lot of time and trouble in the future.

MARQUEE INSTALLATION

Included with your Golden Tee LIVE kit is a new marquee. This will help identify your new game as Golden Tee LIVE. By placing and installing it correctly, it can help give players instant recognition, even from a distance.

Marquee Installation



1. Slide the rectangular marquee mounting frame from its position on the two upright posts.
2. Remove any one of the four side pieces of the mounting frame.
3. Remove the current plastic laminate marquee from the mounting frame, but do not remove the cardboard.
4. Slide the updated marquee into place and reassemble the side piece or pieces. Make sure all of the surrounding pieces of the mounting frame are tight and the plastic laminate is smooth against the cardboard.
5. Slide the fully assembled marquee back into position.

LIGHTED MARQUEE

Incredible Technologies now offers a lighted marquee that can bring increased customer attraction and revenue to your game. For details on the marquee, see **Golden Tee Live 2021>Lighted Marquee Installation Guide**: <http://amusement.itsgames.com/service/manuals>

FINAL CONNECTIONS

COIN DOORS, TEST SWITCH AND VOLUME CONTROL

Wire the coin doors as per the Input/Output Connections table in Appendix B. Connect the door lamps to the appropriate (+12Vdc or +5Vdc) supply. Some games have separate power supply outputs for the lamps. Install a test switch somewhere convenient inside the coin door area. This switch allows you to enter System Setup Menus, run diagnostics, and see or clear audits. Make it readily accessible through the coin door. Golden Tee LIVE has the ability to adjust volume at any time during a game. Install two push button switches (not included) inside the coin door for easy access. Connect the switches to the appropriate connections. Refer to the Input/Output Connections table in Appendix B.

INITIAL POWER-UP

There are several steps you should take when powering up your Golden Tee LIVE for the first time. This is a quick checklist for you to follow when doing your first initial power-up:

- ❑ Plug in the game and turn it ON; be sure the game powers up correctly into the attract mode.
- ❑ Adjust volume levels to desired settings.
- ❑ Adjust monitor settings for best picture.
Note: Sound and Video Tests are available through the System Tests Menu. They are beneficial when making any adjustments. Proper monitor and sound adjustment is very important.
- ❑ Try all money slots. Drop quarters or tokens through to check the coin mechanisms and insert a bill into the bill acceptor. Make sure the game is adding credits.
Note: Golden Tee LIVE supports most bill acceptors. Installing a bill acceptor is highly recommended and will increase your earnings. Refer to your bill acceptor's manual for installation specifications. The bill acceptor can be wired to J205 Pin 5 on the I/O Board.
- ❑ Test all of the player input controls. You can use the PLAYER CONTROL TESTS in the SYSTEM SETUP MENU.
- ❑ Upon initial power-up the game is set to factory default settings. These settings affect game elements such as number of credits per coin, difficulty settings, etc. The OPERATOR MENUS section will describe how to alter these settings for your location.

Congratulations! You have finished installing Golden Tee LIVE!

GOLDEN TEE LIVE SYSTEM SETUP MENUS

SYSTEM SETUP MENUS

Navigating the Menu System

The System Setup menus cover a variety of important areas including collections, tests, game adjustments, and optional settings. You should familiarize yourself with these menus, as they are designed to optimize your game for your location and your business. Pay particular attention to the Collection menus, as they will detail how much money to give to your location, and how much money to set aside for ITNet. There are also menus that allow you to adjust various split percentages for a variety of different charges. These screens can help you maximize your investment and involve your location in the costs associated with your equipment.

Entering System Setup Mode

There are two ways to enter System Setup. Open the coin door and press the Test button to access the game's System Setup software menu system. Or, from the I/O Board, move the DIP switch SW202 position 4 to the ON position. This switch needs to be moved back to OFF to exit the System Setup menus. Refer to the diagram in Appendix D for all DIP switch settings.

Selecting a Menu

A menu option can be selected at any time by rolling the trackball up or down or by pressing the Left or Right buttons.

Choosing a Menu/Option

A menu option can be chosen at any time by pressing the Start button.

Changing a Value

A value can be changed at any time by rolling the trackball left or right.

Note: Some features may not be allowed in certain state or local jurisdictions. Be sure to check your local laws before activating or allowing any features that may be questionable in your area.

MAIN MENU

The Main Menu displays five main areas that make up System Setup mode. Please familiarize yourself with these areas, as they will help you maximize your earnings potential.

Collections & Earnings – See Page 29

This section displays your machine's monetary activity and details the various areas for income and expenses. This section should be reviewed during every collection to make sure you manage your split correctly.

General Settings – See Page 30

This area allows you to adjust operator settings, perform system tests, and reset your game back to factory settings.

Troubleshooting Shortcuts – See Page 41

This section presents a variety of tests and menus that will help you troubleshoot any problems you may be having with your game. The available sections are also accessible through the other main sections.

Golden Tee Settings & Audits – See Page 42

This area allows you to adjust settings specific to Golden Tee LIVE including the player cost schedule, game features, and game audits.

ITNet Settings – See Page 47

This section details various ITNet settings, such as game registration and connection settings with ITNet.

Exit

This will exit the System Setup menus and take you back into the game's attract mode.



COLLECTIONS & EARNINGS MENU

This menu allows you to perform a collection or view various earnings and fees.

Do Collection

This section is used when making a collection. The various screens will detail the cost breakdowns and show you how much of the cash box is to be paid to the location. Please take some time to familiarize yourself with this section. Using it wisely can save you money.

Clear Unused Cash

Sometimes when making a collection there is money in the game that has not yet been played. Use this setting to clear the unused cash from the screen so your future collections will reconcile with game play.

Add Free Cash

Use this setting to add money to the game for free plays that do not advance the hard meter.

Back

This will take you back to the **Main Menu**.

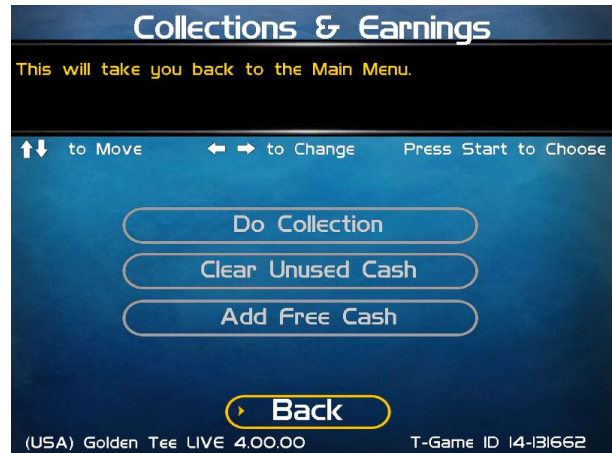

DO COLLECTION

This screen is the main collection screen. It is highly recommended that you view this screen with every collection and reset it when your collection is complete.

This screen displays the following helpful information:

Collection Date Range

The displayed dates are from your last collection until today.

Days in Operation

The number of days the machine was active and available for play since the last collection.

Total Income

The total income your machine made for this time period.

Total Fees

The total of the various fees that need to be set aside before making your split.

Balance

The total income minus the total fees.

Operator Portion of Balance

The amount of the collection that the operator keeps.

Operator Owes Location

The amount of the collection that you pay your location.

Back

If you do NOT wish to perform a collection and reset the audits, highlight Back to exit this screen and return to the **Collections & Earnings** menu.

Do Collection and Exit

If you wish to perform a collection and reset the audits (recommended), highlight Do Collection and Exit and press Start. This will set all the fields in the Do Collection screen to zero. Be sure to empty your cash box at the same time, so these screens will match the money at your next collection. Make sure it is an 'Actual Collection' not an 'Estimated Collection'.

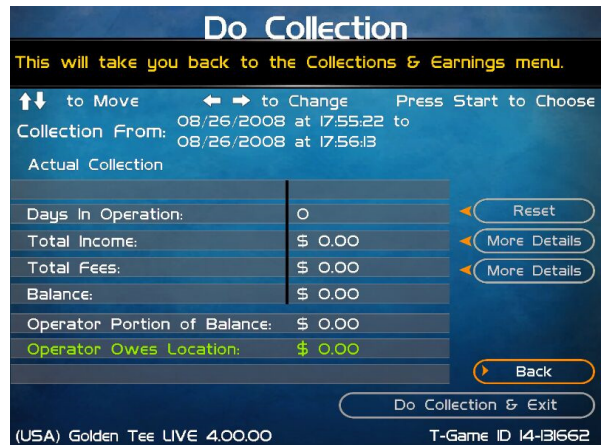

Reset (Across from Days in Operation)

On the Do Collection menu page: Resets the number of days in field operation to zero.

More Details (Across from Total Income)

On the Do Collection menu page: Displays a breakdown of Total Income, including income from Cash, Player Wallet, Credit Card purchases, and various promotional or Gift Cards.

From the Total Income menu select 'More Details' next to Cash to see Collection Income Details menu at right, which has a breakdown of total player amount and the Operator/Location portions.

	Operator Portion	Location Portion	Total
Cash:	\$ 914.83	\$ 609.88	\$ 1524.71
Player Wallet:	\$ 32.72	\$ 14.03	\$ 46.75
Credit Card:	\$ 0.00	\$ 0.00	\$ 0.00
Operator Money Card:	\$ 51.00	\$ 0.00	\$ 51.00
ITNET Money Card:	\$ 0.00	\$ 0.00	\$ 0.00
FREE CASH *	\$ 6.50	\$ 0.00	\$ 6.50
TOTALS:	\$ 998.55	\$ 623.91	\$ 1622.46

*Not Included In Totals

(USA) Golden Tee LIVE 11.04.02 T-Game ID 14-000075

More Details (Across from Total Fees)

On the Do collection menu page: Displays a breakdown of the various fees, including the ITNet fees, money for the Prize Fund, Communication fees, Credit Card fees, Software Update fees and Hardware Upgrade fees. Note: Software Update Fees and Hardware Upgrade Fees are included for your convenience, to help you cover the costs of owning and operating your equipment. These two line items are NOT included on your monthly ITNet statement.

Total Fees:	\$ 26.13
ITNET Fees:	\$ 0.00
Prize Fund:	\$ 0.00
Communication Fees:	\$ 3.04
Credit Card Fees:	\$ 0.00
Software Update:	\$ 23.09
Hardware Upgrade Fee:	\$ 0.00
Taxes:	\$ 0.00
Operator Remits:	\$ 26.13
Location Remits:	\$ 0.00

(USA) Golden Tee LIVE 16.04.00 T-Game ID 14-178014

GENERAL SETTINGS

The General Settings menu houses various adjustable settings relating to the cabinet, and is divided into two sections.

Operator Adjustables

This area allows you to adjust options like volume, attract mode sounds, and money slot settings.

System Tests

This area allows you to perform diagnostics including video adjustments, input tests, and sound tests.

Back

This will take you back to the **Main Menu**.

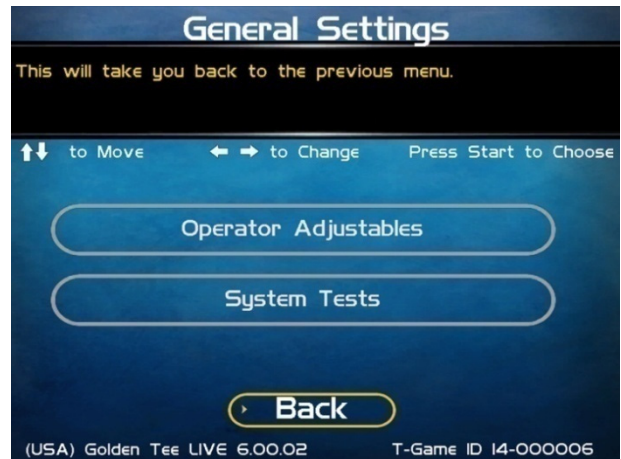

OPERATOR ADJUSTABLES

This menu contains adjustable settings that pertain to you and your business. Please familiarize yourself with this section, as it can help you maximize the game's earning potential.

General Adjustments

This area allows you to adjust options like upper monitor settings and money modes.

Money Slot Adjustments

This area allows you to adjust the settings of your various money slots on your cabinet.

Sound Adjustments

This area allows you to adjust the various sound settings including attract mode sounds, game volume, and stereo setup.

Collection Settings

This critical area allows you to adjust various fees and splits for your collections.

Reset to Factory Settings

This option allows you to reset all the settings found in the Operator Adjustables section to factory defaults.

Back

This will take you back to the **General Settings** menu.



GENERAL ADJUSTMENTS

Coin Message

The default is set to Insert \$.

Accept Credit Card

This Yes/No choice lets you decide to allow game purchases with credit cards. **The default is set to Yes.**

Game Mode

This lets you toggle between Money/Free Play. **The default is set to Money Play.**

Advertisements

Golden Tee LIVE 2021 can display advertisements when available. Advertisements typically involve alcohol or are directed at a mature audience. This option can be turned off in venues where minors may be present.

Reset Values

This option allows you to reset the settings found in the General Adjustments menu to their factory defaults.

Back

This will take you back to the Operator Adjustables menu.



MONEY SLOT ADJUSTMENTS

Money Slot 1

This adjusts how much one pulse equals for Money Slot 1. **The default is set to \$0.25.**

Money Slot 2

This adjusts how much one pulse equals for Money Slot 2. **The default is set to \$0.25.**

Money Slot 3

This adjusts how much one pulse equals for Money Slot 3. **The default is set to \$0.25.**

Credit Card

See the General Adjustments screen.

Reset Values

This resets all values to their default value located on this page.

No

This will not perform the reset and take you back to the previous menu.

Yes

This will perform the reset and take you back to the previous menu.

Back

This will take you back to the Operator Adjustables menu.



SOUND ADJUSTMENTS

In Game Volume

This option lets you adjust the In Game volume from OFF to 100%. **The default is set to 30%.**

Attract Volume

This option lets you adjust the Attract Mode volume from OFF to 100%. **The default is set to 30%.**

Attract Mode Sounds

This adjusts how often sounds are played in Attract Mode: Never, Rarely, Sometimes, Often and Always. **The default is set to On – Sometimes.**

Stereo/Mono

This option is where you select stereo or mono setup. **The default is set to Stereo.**

Reset Values

This resets all values to their default value located on this page.

Back

This will take you back to the **Operator Adjustables** menu.



COLLECTION SETTINGS

Golden Tee LIVE allows you to adjust costs and percentages for the various income types that are received. Use this menu to determine how much you want your location to help you pay for these charges and services.

Set Hardware Update Fee

This menu allows you to adjust the Hardware Update Fee. This fee is included for your convenience, as a method to have the location pay for part of your equipment. The default value for 2021 machines is \$0.00 per week. Adjust this value to an appropriate amount for your location.

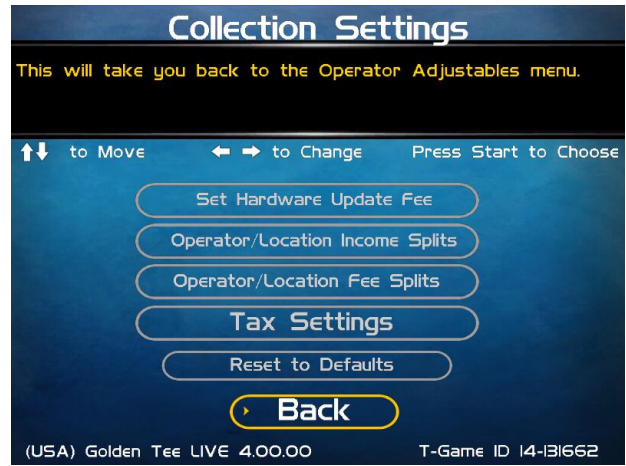

Note: Hardware Update Fees are included for your convenience, and are NOT included on your monthly ITNet statement.

Operator/Location Income Splits

Use this menu to fine-tune your splits for any generated income. Since there may be times when you have to pay the location before you actually have the cash in hand, you may want to adjust the split in your favor to cover the waiting period. The default settings are displayed on the accompanying screen.

The adjustable settings refer to income generated from:

- Cash
- Player Wallet
- Credit Card
- ITNet Money Card
- Operator Money Card

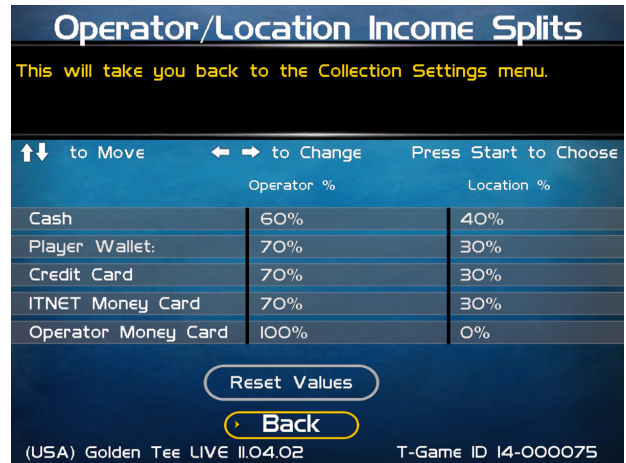

Operator/Location Fee Splits

Use this menu to determine how you wish to split the various fees with your location. For example, since there is a fee associated with credit card usage, you may want to adjust the split in your favor to help cover the costs of the transaction fees.

- ITNet Fees
- Prize Fund Fees
- Credit Card Fees
- Communication Fees
- Software Update Fees
- Hardware Update Fees



Note: Software Update Fees and Hardware Update Fees are included for your convenience, and are NOT included on your monthly ITNet statement.

Tax Settings

Many states require special taxes or license fees that affect your bottom line. Use this menu to separate these costs from your collection before making your normal split.

Set Tax Rate

This menu allows you to adjust your current tax rate percentage.

Set Tax Type

This menu helps you determine what part of the collection is taxed, and who pays for these taxes.

Set Tax Split

This menu allows you to split the tax fees with the location.

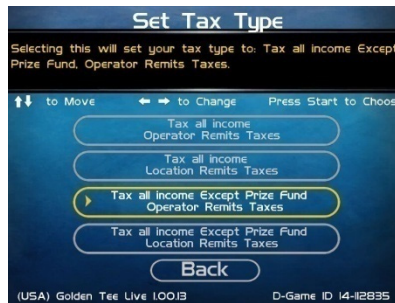
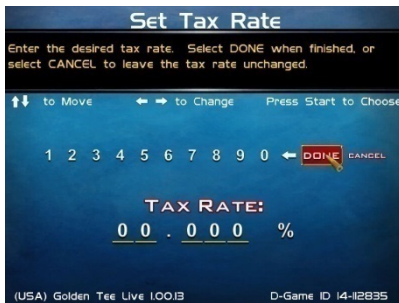
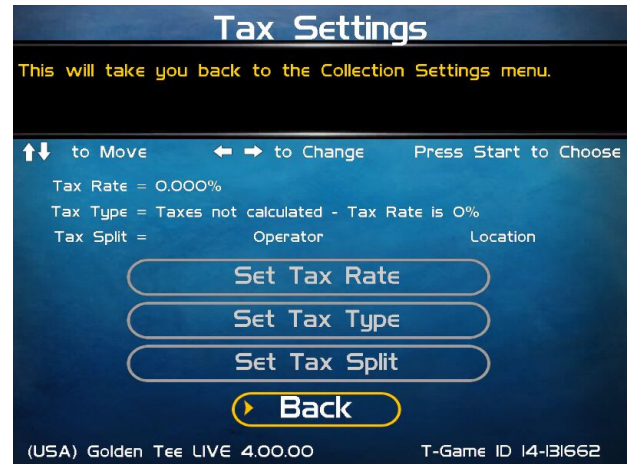

Reset to Defaults

This menu will set all of the collection settings to their factory default values. A verification screen will display to make sure you agree to the change.

Back

This will take you back to the **Operator Adjustables** menu.

RESET TO FACTORY SETTINGS

This menu will reset ALL settings in the Operator Adjustables section to their default values. A verification screen will display to make sure you agree to the change.

Note: This process may take several minutes to complete.

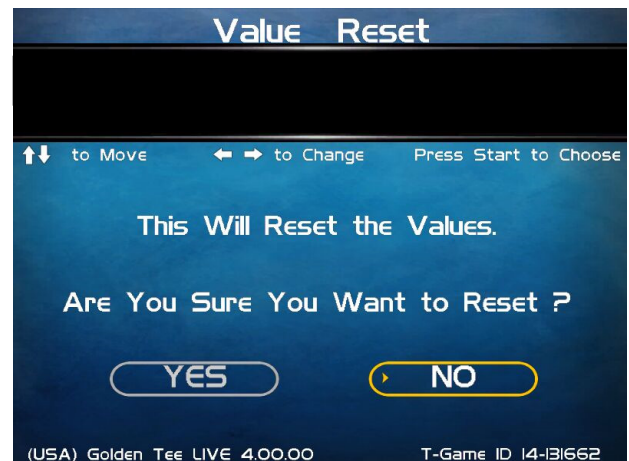

SYSTEM TESTS

This area allows you to perform diagnostics including video adjustments, input tests, and sound tests.

Video Tests

This area has tests that will help you to adjust your game's color, contrast, and screen size.

Sound Tests

This area has tests that will help you adjust your game's audio setup by playing a stored sound, a streaming sound, and testing the speaker(s).

Player Control Tests

This option allows you to test all inputs including trackball, buttons, and money slots.

Mechanical Meter Test

This test makes the hard meter adjust by one to make sure it is functioning properly.

Hardware Tests

This area includes a series of diagnostic screens and tests to help you make sure your game is functioning correctly.

Back

This will take you back to the **General Settings** menu.



VIDEO TESTS

The Video Tests section has a variety of tests that will help you adjust your monitor.

Color Test

This area will take you to a series of tests to adjust your monitor's RGB settings to have each color display properly.

Contrast Test

This area will take you to a series of tests to adjust your monitor's brightness/contrast so the game displays properly.

Screen Size Adjustments

Use this screen to align your monitor so that all the circles appear as circles and the boundary line appears on the edge of each side of the screen.

Back

This will take you back to the **System Tests** menu.



COLOR TEST

Color Grid Adjustment

Adjust your monitor to have each colored box display properly.

Red Screen

Adjust your monitor to have red display properly.

Green Screen

Adjust your monitor to have green display properly.

Blue Screen

Adjust your monitor to have blue display properly.

Back

This will take you back to the **Video Tests** menu.

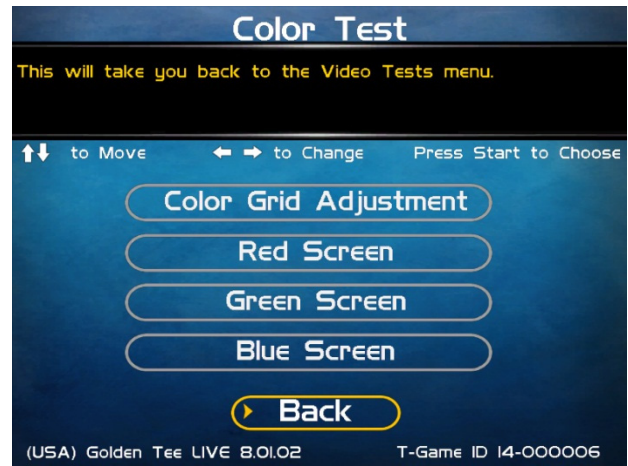

CONTRAST TEST

White Screen

Adjust your monitor to have white display properly.

50% White Screen

Adjust your monitor to have 50% white display properly.

25% White Screen

Adjust your monitor to have 25% white display properly.

Black Screen

Adjust your monitor to have black display properly.

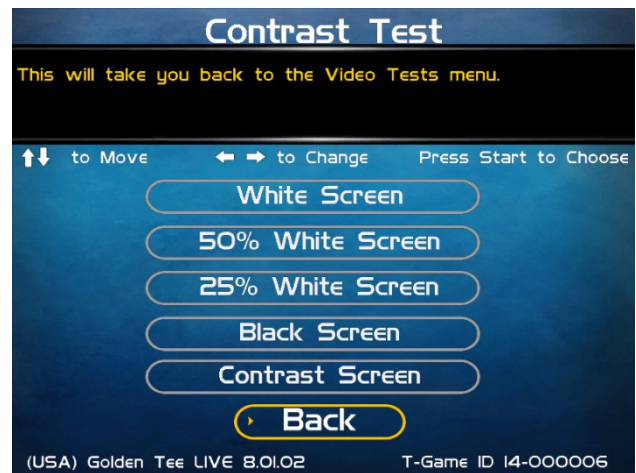

Note: May not work on older or often used monitors. If you have a monitor that's old or has been used often you may not be able to adjust the contrast and/or brightness levels accordingly. In this case adjust the monitor for best performance while getting close to the recommended settings.

Contrast Screen

This option is a test you can use to adjust your monitor's contrast and brightness settings to have the boxes displayed properly.

Back

This will take you back to the **Video Tests** menu.

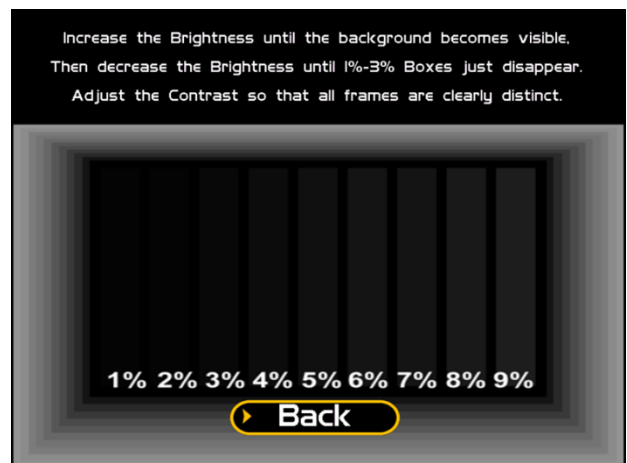

SCREEN SIZE ADJUSTMENT

Use this screen to adjust the size and aspect ratio of your picture. Press the Start button to exit.

If you are using an HDTV display, you may need to adjust this screen to see the complete image. Use the trackball to highlight BIGGER or SMALLER and press the Start button to adjust the screen image. Press DONE to exit.

Note: Adjusting the screen size will prompt a reboot upon exiting this menu.

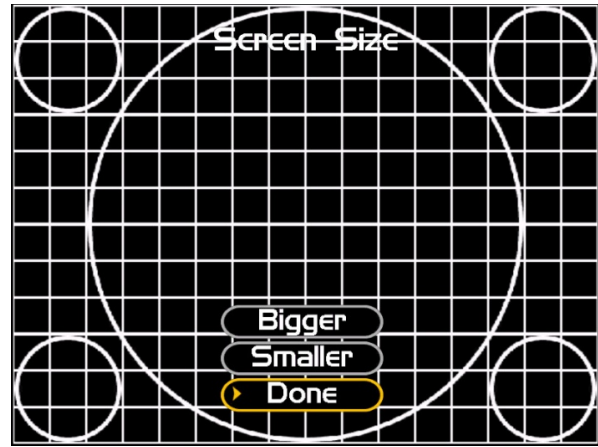

SOUND TESTS

Stored Sound

This will play a stored sound so you can make sure your audio setup is functioning properly.

Streaming Sound

This will play a streaming sound so you can make sure your audio setup is functioning properly.

Speaker Test

This test will say MONO if you have your game set to Mono or LEFT and RIGHT if you have it set to stereo so you can make sure your audio setup is functioning properly.

Back

This will take you back to the **System Tests** menu.

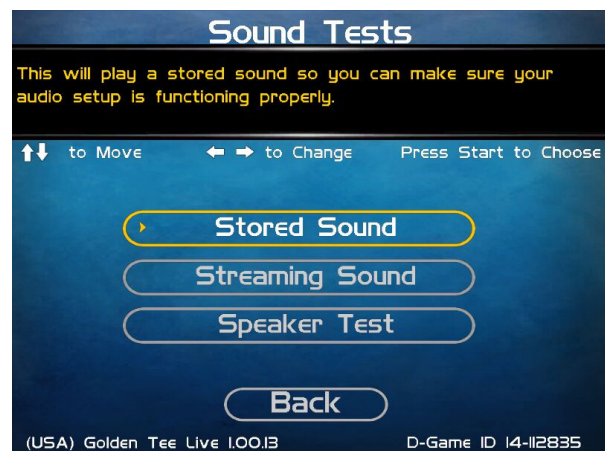

PLAYER CONTROL TESTS

Use this screen to test all of the inputs, including the trackball, buttons, money slots and card reader. When an input is active the appropriate graphic image will light. Press the Left, Right and Start buttons simultaneously to exit this test screen.

When testing the trackball, the Current value will change depending on the direction the ball is spinning. The Max value will display the largest number reached during the test. There is no exact number to determine whether a trackball is malfunctioning, but in general the Max number should be close to the same when spinning up and down, and close to the same when spinning left and right.

When testing coin and bill acceptor switches, the number of pulses will appear below the appropriate image. On the keypad the numbers illuminate when pressed.

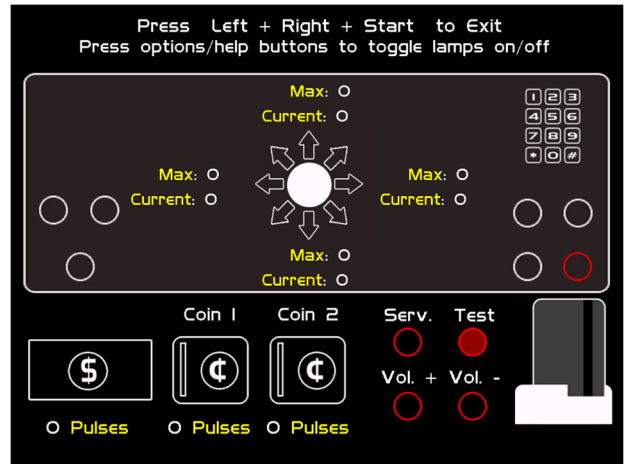

MECHANICAL METER TEST

Click Meter

This test makes the hard meter adjust by one to make sure it is functioning properly. You should hear a clicking sound.

Back

This will take you back to the **System Tests** menu.

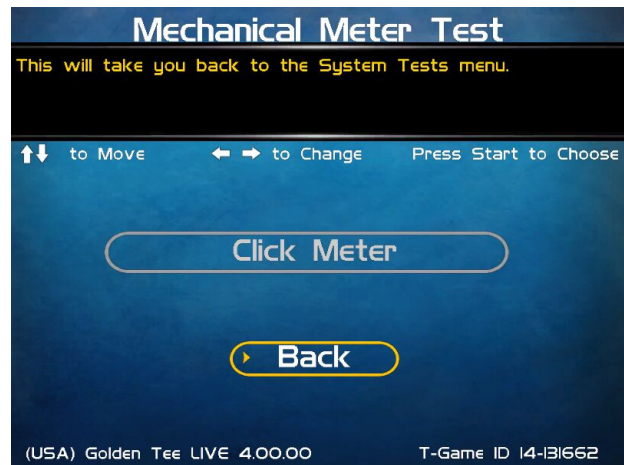

HARDWARE TESTS

This area includes a series of diagnostic screens and tests to help you make sure your game is functioning correctly.

Hardware/Software

This area has options to view your System, USB, and Version info.

Check Hard Drive

This test checks the integrity of your hard drive's data.

Note: This test can take several minutes.

Check Cooling

This test helps you make sure your game is functioning at the proper temperature and all fans are working.

Check Card Reader

This tests the functionality of the card reader and displays some details about the card tested.

Back

This will take you back to the **System Tests** menu.



HARDWARE/SOFTWARE

System Info

This is a list of your game's current basic system information.

USB Info

This is a list of your game's current USB devices.

Version Info

This is a list of your game's software and firmware versions.

Back

This will take you back to the **Hardware Tests** menu.



SYSTEM INFO

This is a list of your game's current basic system information, including Hard Drive, CPU and Video Card.

Back

The Back button takes you back to the **Hardware/Software** menu.

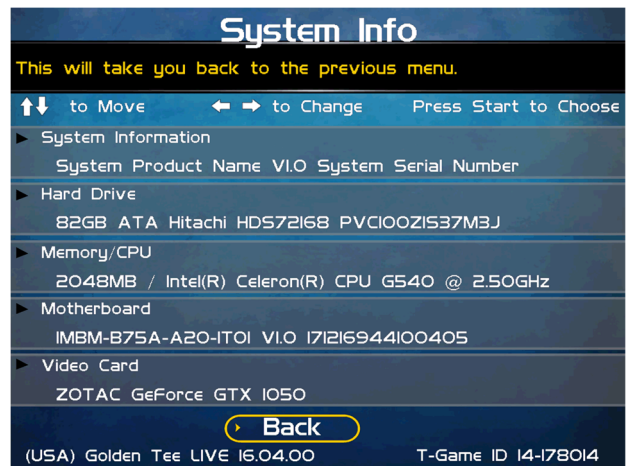

USB INFO

This is a list of your game's current USB devices.

Back

The Back button takes you back to the **Hardware/Software** menu.



VERSION INFO

This is a list of your machine's software and firmware versions.

Back

The Back button takes you back to the **Hardware/Software** menu.



CHECK HARD DRIVE

Check File Data

This test checks the integrity of your hard drive's data.

Select **Begin Test** to initiate the process.

Note: This test can take up to 3 hours to complete.

If this test succeeds you will see the message: **Status: Hard Drive Functioning Properly**. If this test fails, you will see the message: **Hard Drive Error (#)**

Select **Back** to skip the test and return to the **Check Hard Drive** menu.

Check File System

This test REBOOTS YOUR GAME and performs a low level systems check of the integrity of your hard drive.

Note: This can take several minutes.

Check Hard Drive Health

This runs a test on your hard drive to determine its overall condition

Back

This will take you back to the **Hardware Tests** menu.

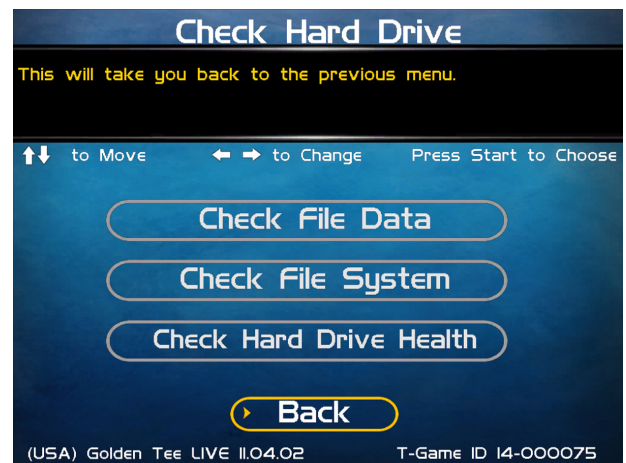

CHECK COOLING

This checks that your game is functioning at the proper temperature and all fans are working. The current status is color-coded for easy viewing. If the results are displayed in green, your cabinet is at normal settings.

Note: Not all hardware configurations have identical cooling information available.

Back

The Back button takes you back to the **Hardware Tests** menu.

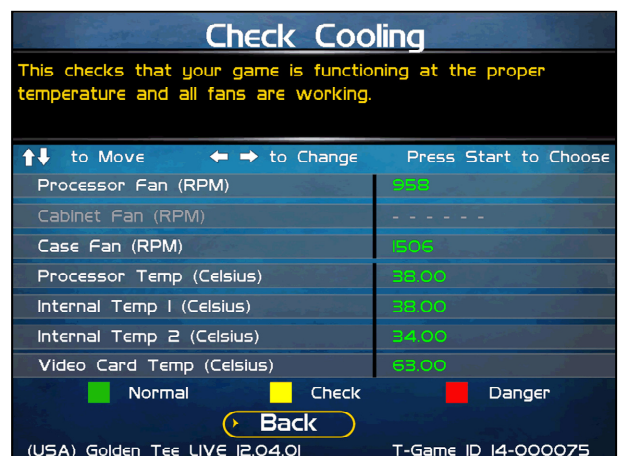

CHECK CARD READER

This test will check to see if your card reader can read and recognize properly encoded IT and credit cards.

From this screen, insert a card into the card reader. If the card can be read, a message will appear on the screen.

Back

The Back button takes you back to the **Hardware Tests** menu.



TROUBLESHOOTING SHORTCUTS

This section gathers many of the commonly used tests and menus into one convenient area. Check here first when troubleshooting problems or questions about the integrity of your machine.

The tests that are available in this section are:

Check Card Reader

Check Cooling

Check Hard Drive

Screen Size Adjustments

Communications Settings

Player Control Tests

System Tests

Descriptions of each of these tests and sections can be found elsewhere in this manual.

Back

This will take you back to the **Main Menu**.



GOLDEN TEE SETTINGS & AUDITS

Golden Tee Settings

This section allows you to make custom adjustments to certain features on your machine, including Prize Play, Closest to the Pin, and Hole-N-Win.

Golden Tee Audits

This area allows you to view your money and game purchase audits, as well as reset and clear audits.

Player Cost Schedule

This option allows you to adjust the amount of money it costs a player to play various game types.

Reset Leaderboards & Records

This area allows you to clear any or all local Leaderboards and high score screens.

Note: This process may take several minutes to complete.

Back

This will take you back to the **Main Menu**.



GOLDEN TEE SETTINGS

LIVE Prizes

Turn the ability to play for prizes ON or OFF. There are 18 holes and 50 players per contest.

Delay of Game Timeout

Adjust the timer that senses activity between shots. The Current Value displays the number of seconds between a player's last shot and when the games will timeout the shot and apply a penalty stroke.

Closest to the Pin LIVE

Closest to the Pin LIVE allows players to compete to win a cash prize. There are 9 holes and 35 players per contest. Each player gets one shot per hole and the total closest to the pin distance across all holes determines the winners..

Player Invitational

Enable the ability to play a Player Invitational game. Players can set up private contests between friends on the GT Caddy mobile app, and then pay for and play their rounds on your machine.

Hole-N-Win

Activate the ability for the game to offer special Hole-N-Win opportunities on some holes where allowed. Check your local regulations to determine if this feature is allowed in your area.

Money Shot

Activate the ability for the game to offer the daily Money Shot contest, which allows players to take 3 shots at the same hole with variable wind conditions on each shot. Closest to the pin wins.

More

Selecting More brings you to a second page of Golden Tee settings.



Locked Conditions

Activate the ability for the game to allow for special contests where course conditions are the same for each player. This is generally used during live events and promotions and requires a special activation card. Contact your IT representative for more information.

Daily Prize Contest

Golden Tee LIVE 2021 offers a Daily Prize Contest, which allows an unlimited number of competitors the chance to compete against other players across the country for the best score on one predetermined course. Players can play as many times as they want and enter only their best score. To disable this feature select *Off*.

Events Mode

Activate the ability for the game to allow for pre-determined course conditions with variables such as wind speed and pin placement.

Casual Difficulty

Golden Tee LIVE 2021 offers players the opportunity to play offline in Casual mode.

Casual play is meant for beginners on a local, single machine only. You can set the difficulty of the courses in casual play to adapt the game to the needs of your specific location. Difficulty settings can be adjusted from 1 (easiest) to 5 (hardest). The default setting is 2. Casual mode still allows players to choose clothing items.

Pre-game Casual Clothing

This setting allows a random selection of 30 clothing items (including 2021 clothing but not promotional items) available as a quick selection in Casual format. There are 10 random item types of shirts, pants and hats.

Mulligans

Mulligans allow casual game players to retake a bad shot during their game. To disable this feature select *Off*. Note that mulligans are only available during Casual play.

Real Time Rival Casual

This allows Real Time Rivals mode, where players play against computer-driven AI golfers.

Real Time Rival Online

This allows Real Time Rivals Online Single and Ladder modes, where players play against computer-driven AI golfers using their registered golfer and equipment.#

Operator CTPP

This allows operators to run Closest to the Pin mode on a machine for a designated time.

Reset Values

This resets all Golden Tee Settings to their factory defaults.

Back

This takes you back to the **Golden Tee Settings & Audits page**.



GOLDEN TEE AUDITS

This section displays various counts and totals for a variety of areas of interest. The following values are based on the last reset, the date of which is shown at the top of the screen.

Total Number of 18-Hole Games
Number of 18-Hole Games with Prizes
Number of Daily Prize Games
Number of Casual 1-hole purchases
Number of Money Shot games
Number of Money Shot 6x purchases
Coin Slot 1
Coin Slot 2
Bill Acceptor
Lifetime Money In

This field shows how much total money your machine has made since its initial registration with ITNet. This field is cumulative and is not affected by resetting the audits on this screen.

More

Selecting More brings you to a second page of audit information.

18-Hole Unregistered Contest Games
Number of 18-Hole Stats Play
Number of Casual CTPP Games
Number of Real Time Rival Casual Games
Number of Real Time Rival Online Games
Number of Events Mode Games
Gold Cards purchased
Hole-N-Win Par 3 Plays
Hole-N-Win Par 4 Plays

More

Selecting More brings you to a third page of audit information.

Boxes of Balls Purchased
Sets of Clubs Purchased
Mulligans Purchased
YouTube shots Purchased
CTTP LIVE Plays
Number of Online CTPP games
Number of Invitational games
Bags of 10 Golden Tees Purchased
Bags of 25 Golden Tees Purchased
Bags of 60 Golden Tees Purchased

More

Selecting More brings you to the final page of audit information.

Reset Audits

This will reset all audits to zero and update the date of the last audit reset. The Lifetime Money In field will not be affected by this function.

Back

Select this to return to the **Golden Tee Settings & Audits** menu.

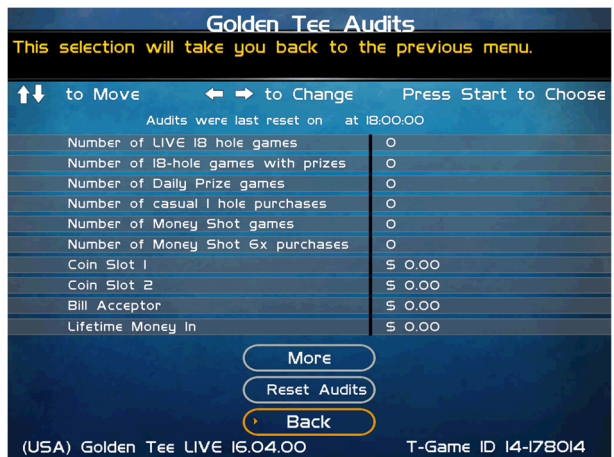

The final audits page has a breakdown of the number players who accepted or declined to play again.

Play Again Accepts
Play Again Declines

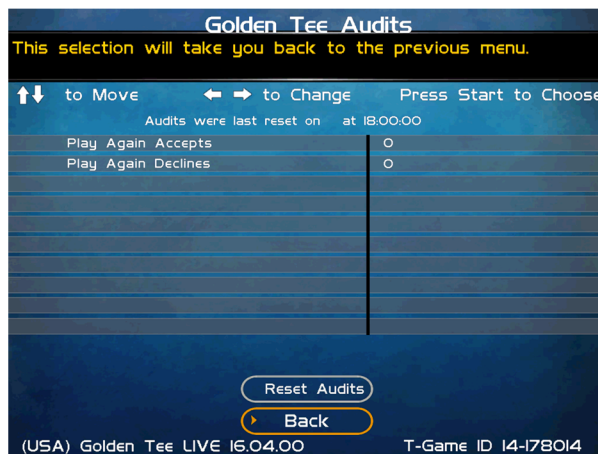

PLAYER COST SCHEDULE

This screen details the costs of various play selections. The player cost is shown as a total, with the Operator Portion and the ITNet portion broken out.

The options below allow you to adjust how much it costs a player to play the various options:

18 Holes LIVE

This is for 18-hole contest play. **The USA default is \$4.00. International defaults may vary.**

CTTP LIVE/Online

This is for Closest to the Pin LIVE contest play. **The USA default is \$2.00 for LIVE play, but \$1.00 is always allocated to the Prize Pool. Online play is \$1.00.**

Stats Play (18 Holes)

This option has all the 18-hole options as LIVE play, except without LIVE leaderboards. Players can save their statistics, view stats on goldentee.com, customize their golfer and use premium balls and clubs. **The USA default is \$4.00.**

Casual (1 Hole)

This adjusts for 1-hole game in Casual Play Mode. **The USA default is \$0.25.**

Casual (18 Holes)

This adjusts for 18-hole game in Casual Play Mode. **The USA default is \$4.00.**

Mulligans

This adjusts the cost of a Mulligan repeat shot in Casual Play Mode. **The USA default is set to \$0.25.**

Daily Contest

This adjusts the cost for an unlimited number of players to compete against other online players on a per day, per course basis. Only the player's best score is uploaded for a chance at the Daily Prize. **The USA default is \$5.00.**

Closest to the Pin Casual

This adjusts the cost for this Casual Mode option that allows one to four players to compete in a 9-hole round of one shot golf. The winner is determined by the lowest total distance. **The USA default is \$1.00 for 9 holes.**

Money Shot

This adjusts the cost for a player to enter their best shot of the day in a daily contest against an unlimited number of online players. **The USA default is \$1.00 for 3 shots.**

Money Shot 6 Play

This adjusts the cost for a player to enter their best shot of the day in a daily contest against an unlimited number of online players. **The USA default is \$5.00 for 18 shots.**

Real Time Rivals Casual

This allows players to enter a contest against various computer AI opponents. **The USA default is \$4.00 for 18 holes.**



Events Mode

This allows players to activate the ability for the game to allow for pre-determined course conditions with variables such as wind speed and pin placement. **The USA default is \$5.00 for 18 holes.**

RTR Online

This allows players to enter a contest against various online computer AI opponents. **The USA default is \$4.00 for 18 holes.**

View Fixed Costs

Selecting View Fixed Costs displays payment settings and splits for some items that are not adjustable.

Reset Defaults

This resets all values to their default value located on this page.

FIXED PLAYER COSTS

This screen details the splits between operator and ITNet from the player.

Play 18/Daily Contest

Displays the additional cost for a player to play for Prizes 18/Daily Contest. **The USA cost is \$1.00.**

Golf Club Sets

Displays the cost for a player to purchase golf clubs in Stats and LIVE Play. **The USA cost is \$2.00.**

Dozen Golf Balls

Displays the cost for a dozen golf balls in Stats and LIVE Play. **The USA cost is \$0.50**

Hole-N-Win Par 3

Displays the cost for a player to play a par 3 Hole-N-Win. **The USA cost is set to \$0.50.**

Hole-N-Win Par 4

Displays the cost for a player to play a par 4 Hole-N-Win. **The USA cost is set to \$1.00.**

Closest to the Pin LIVE

Displays the additional cost for a player to play Closest to the Pin LIVE. **The USA cost is \$1.00.**

Bag of 10/25/60 Golden Tees

Displays the cost for the players to purchase Golden Tees in Stats and LIVE Play. **The USA cost is \$0.50/\$1.00/\$2.00.**

Paid YouTube™ Shot

Displays the cost for the players to purchase the posting of their favorite shot to YouTube™. **The USA cost is \$0.50.**

Money Shot

Displays the cost for a player to play for a Money Shot. **The USA cost is \$0.50.**

Money Shot 6 Play

Displays the cost for a player to play for a Money Shot. **The USA cost is \$1.50.**

Fixed Costs	Operator Portion	ITNET Portion	Cost To Player
Prizes 18*/Daily	\$ 0.00	\$ 1.00	\$ 1.00
Golf Club Sets	\$ 1.00	\$ 1.00	\$ 2.00
Dozen Golf Balls	\$ 0.25	\$ 0.25	\$ 0.50
Hole-N-Win Par 3	\$ 0.00	\$ 0.50	\$ 0.50
Hole-N-Win Par 4	\$ 0.00	\$ 1.00	\$ 1.00
Closest to the Pin LIVE*	\$ 0.00	\$ 1.00	\$ 1.00
Bag of 10 Golden Tees	\$ 0.25	\$ 0.25	\$ 0.50
Bag of 25 Golden Tees	\$ 0.50	\$ 0.50	\$ 1.00
Bag of 60 Golden Tees	\$ 1.00	\$ 1.00	\$ 2.00
Paid YouTube Shot	\$ 0.25	\$ 0.25	\$ 0.50
Money Shot	\$ 0.00	\$ 0.50	\$ 0.50
Money Shot 6 Play	\$ 0.00	\$ 2.50	\$ 2.50

RESET LEADERBOARDS & RECORDS

Use this menu to reset various machine-specific Leaderboards.

Reset Leaderboards

This leaderboard is displayed after every hole during a casual game. Use this setting to clear the current play data. This option resets all Local Leaderboards.

Reset Course Records

Course records, such as best score on each course, are displayed on various screens during a game and in the attract mode, and replayed in the game's attract mode. Use this setting to clear all course records and game highlights.



Reset RTR Character Records

Allows operators to reset all Real Time Rivals Character records

Reset All

Use this setting to clear all Leaderboards, local records and game highlights. This process could take several minutes to run so please be patient.

ITNET SETTINGS

This section details various ITNet settings, such as game registration and connection settings with ITNet.

Change Location/Register Game

This section lets you update the information for the location that your game is currently in and send it to ITNet.

Location Information

The current location where the game is registered

If your machine is unregistered, the screen will display **Register Game**. If your machine is already registered, the screen will display **Change Location**.

Communication Settings

This section lets you select and adjust various communication options.

Connection Tests

This section tests your communication connections for integrity and reliability.

Back

Select this to return to the **Main Menu**.

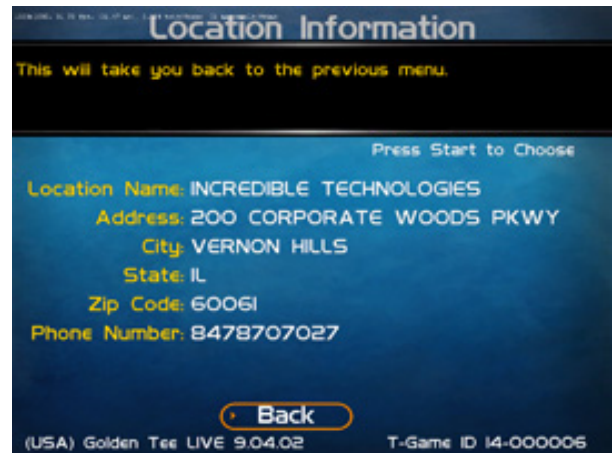

Note: These sections require an ITNet Operator ID Card and a working connection to ITNet to activate.

REGISTER GAME

Select this option and insert your Operator ID Card into the Card Reader. Use the trackball and Start button to enter the location information into the on-screen form. Be sure the information you enter is accurate and spelled correctly. This information will be used to identify the game and will be posted on the Golden Tee website, so players can find and play on your machines.

The zip code is very important and is used to find the most optimal wireless service available. Once the zip code is entered, the machine will contact ITNet for a list of available cities. Verify that the city and zip code are accurate. Once complete, exit the screen to complete the registration process.

CHANGE LOCATION

Select this option and insert your Operator ID Card into the Card Reader. If the machine is properly registered, you will be asked to enter the zip code of the location the machine is placed in. The zip code is very important and is used to find the most optimal wireless service available. Once the zip code is entered, the machine will contact ITNet for a list of available cities. Verify that the city and zip code are accurate.

Next enter the name and phone number of the location. This information will be used to identify the game and will be posted on the Golden Tee website, so players can find and play on your machines. Verify that all information is accurate. Once complete exit the screen to complete the location change process.

COMMUNICATION SETTINGS

This screen shows the type of communication device that is currently in use, and its status and signal strength. In most cases, the wireless modem will be in use and active. If your machine is in a location with low signal strength, check the Troubleshooting section of the manual for ways to help boost your signal.

Configure Ethernet Settings

If your machine is in a location with low signal strength, and none of the suggestions on boosting your signal help, you may need to connect to ITNet using a broadband connection through Ethernet.

Back

Select this to return to the **ITNet Settings** menu.



CONFIGURE ETHERNET SETTINGS

Depending on your system setup, you may need to manually set specific settings for Ethernet to work. Use this menu to enter these settings.

Enable DHCP

Set this to Yes if your service provider or your router hardware has DHCP enabled. DHCP automatically sets the IP, Gateway and Net Mask.

If you edit the IP below to anything other than 0.0.0.0, it automatically changes Enable DHCP to No.

If No DHCP, Static IP

Set this to the IP that your service provider issued, or an IP from your router's subnet that is not already being used.

If the IP is set to 0.0.0.0, it automatically changes Enable DHCP to Yes.

Gateway

Set this to the Gateway that your service provider issued, or the IP address of your router. Example: 192.168.1.1

Net Mask

Set this to the Net Mask that your service provider issued, or if you are using a router it is typically 255.255.255.0. Example: 255.255.255.0

Test Ethernet

Selecting this will initiate a network connection using your entered network settings for DHCP or Static IP, Gateway and Net Mask. If the connection succeeds, a latency time check is also performed. Results are displayed at the end of the tests. It is a good idea to perform this test anytime you make changes to any of these settings to make sure everything works.

Back

Select this to return to the **Communication Settings** menu.

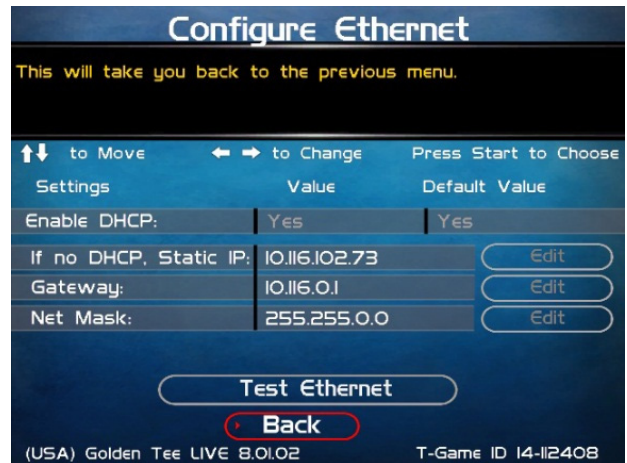

CONFIGURE WI-FI SETTINGS

To setup Wi-Fi, see the GT LIVE Online Access Configuration Guide included with your Golden Tee LIVE or Update Kit. It is also possible to download from <http://amusement.itsgames.com/service/manuals>. Look under the heading for Golden Tee LIVE 2021.

Connection Tests

Use this section to test the connection to ITNet.

Check Latency Time

This test will measure the time it takes for your game to communicate with ITNet. If successful, the delay time in seconds will be displayed.

Force Call to ITNet

This test will initiate a connection with the ITNet system and give a result status.

Back

Select this to return to the **ITNet Settings** menu.



GOLDEN TEE LIVE TROUBLESHOOTING GUIDE & REFERENCE

APPENDIX A TROUBLESHOOTING GUIDE

HDTV Video Problems		
Symptom	Probable Cause	Solution
There is no picture during boot up.	The HDMI cable is connected to the wrong output on the system box	Be sure the HDMI cable is connected to the video card HDMI output. Refer to Appendix D.
	The wrong input is selected on the TV	Select the input source in the TV menu to match the input the HDMI cable is physically connected to.
No picture after boot up or loading game is completed	A normal black screen is displayed for a period of time just before 3D graphics are displayed.	Be sure to wait at least two minutes after LOADING GAME is displayed to see if video appears.
	HDMI cable is connected to the wrong onboard video output of the system box	Be sure the HDMI cable is connected to the correct video card HDMI output on the far right side of the system box. Refer to Appendix D.
Picture is too big for the screen or does not fill the entire screen.	Incorrect DIP switch configuration.	See Appendix D for proper video configuration
	I/O board DC power cable is not connected.	Be sure the I/O board DC power cable is connected from the System box to the I/O board. See Appendix D.
	TV video setting is not set for a standard 16:9 aspect ration	Be sure the TV is not in a Zoom mode or another mode that is not the standard 16:9 wide screen mode
	Increase or decrease screen size in the games adjustments.	Location is in General Settings>Operator>System Tests>Video Screen Settings>Screen Size Adjust
No Audio or low volume.	HDTV is muted	Turn the mute off in the HDTV MENU.
	Volume is turned down on the monitor or game sounds are set too low.	Adjust the volume on the game to 75% and then adjust the game volume to your desired level.

Wireless Connection Problems		
Symptom	Probable Cause	Solution
Low Signal Strength See Appendix F for more information.	Placement in location is impeding the signal.	Place the game near a window or doorway to yield a better signal.
	Antenna needs to be repositioned for best signal strength.	Adjust the orientation of the Antenna within the cabinet. Be sure the antenna is vertical (straight up and down) Sometimes a slight tilt in one direction will help. Rotate the Antenna 180 degrees. Reposition the Antenna to the opposite side of the cabinet. See Appendix F for hints on methods for optimal signal strength.
	Signal strength in location is weak.	Add a signal booster. In rare instances a booster can be added for an additional charge. Please call customer service for more information. P/N 900100510

Sound Problems		
Symptom	Probable Cause	Solution
No sound	Switch settings on the I/O boards are set incorrectly. If using digital video, HDMI, your switch settings on the I/O board need to be set correctly.	Adjust the switch settings. Refer to appendix D
	Attract mode sounds may be set to all off. You will have sounds when playing the game.	Choose 1 of the 5 Attract Mode sound options in Sound Adjustments
	Volume is set to the lowest level.	Adjust the game side audio in General Settings> Operator Adjustments> Sound Adjustments
		Adjust the volume on the TV
	TV is muted	In the TV's menu set the mute of off or unmuted
Distorted or scratchy game sounds	Bad HDMI cable	Replace HDMI cable
	Bad TV speakers	Replace or repair the TV

Nighthawk System Box Problems		
Symptom	Probable Cause	Solution
No video and fans are not heard or viewed spinning on the System Box.	No AC power to the Nighthawk System Box or Cabinet.	Verify AC voltage is connected to the Nighthawk System Box and the cabinet
	Power switch on the Nighthawk System Box is off.	Flip the Nighthawk System Box Power switch to on.
	Main cabinet power switch is off.	Be certain the main cabinet switch is set to on.
	Soft Power Shutdown	Press the Soft Power button with the power turned on. Or, short the top 2 pins of the 6-pin connector on the system box. See Appendix D.
	Defective Nighthawk System Box.	Be certain all other possibilities are explored before replacing the Nighthawk System Box.
No video but fans are spinning	HDMI Cable is not connected to the video card HDMI output	Connect the HDMI cable to the Video Card HDMI output. See Appendix D System Diagrams.
	TV is not turned on	Turn on the TV
	The correct video input is not selected on the TV.	Select the correct video input using the TV menu.
	Incorrect video configuration	See Video Problem section

Control Problems		
Symptom	Probable Cause	Solution
Button does not work	Switches Common post is not connected to digital ground.	Verify continuity to digital/power supply ground.
	Signal wire is not connected to the Normally Open post of the switch.	Verify continuity from the I/O board to the Normally Open post of the switch.
	The DC power cable from the computer to the I/O board is not connected	Connect the I/O power cable from the Computer to the I/O board. See Appendix D
	Switch is defective	Replace Defective Switch
Button always indicates closed in the player control test. Pressing it will show it is not depressed.	Signal wire is connected to the Normally Closed post of the switch.	Connect signal wire to the Normally Open post of the switch.
Button always indicates closed in player control test even with the switch disconnected entirely.	The DC power cable from the computer to the I/O board is not connected	Connect the I/O power cable from the Computer to the I/O board. See Appendix D
	Defective I/O board	Test on a known good system. Replace if necessary.
Trackball not functioning in any direction	Trackball is not connected to the I/O board properly.	Verify the trackball is connected to J208 labeled trackball on the I/O Board.
	Defective trackball Interconnect cable	Verify continuity on the trackball Interconnect cable. Repair or replace the cable
	Trackball is defective.	Replace the trackball
Trackball works intermittently	Inside of the trackball is dirty.	Clean the inside of the trackball.
	Rollers are worn	Replace the rollers and bearings.
	Trackball is over-tightened	Do not over-tighten the trackball. Tighten just enough to flatten the lock washers.

Video Problems		
Symptom	Probable Cause	Solution
No picture on monitor	I/O board DIP Switch settings are set wrong.	Adjust DIP Switch settings to match the resolution of the monitor you are using. Refer to I/O DIP Switch Settings in Appendix D.
	HDMI cable is connected to the onboard video output instead of the video card HDMI port.	Connect the HDMI cable to the video card HDMI output indicated on the diagram in Appendix D.
	Bad HDMI cable or not securely connected.	Replace HDMI cable or fully connect the HDMI cable.
	TV input is not selected in the TV menu to match the HDMI input the HDMI cable is physically plugged into.	Select the proper input in the TV menu. Consult the TV menu.
	TV HDMI port is defective	Try another HDMI port on the TV and be sure to select the correct input in the TV menu.
	TV is not on or has no AC power connected.	Turn on TV make sure the TV has AC power.
	Defective TV	Replace the TV
	Defective System Box	Be certain all other possibilities are explored before replacing the Nighthawk System Box.
Scrambled picture	I/O board DIP Switch settings are set wrong.	Adjust DIP Switch settings to match the resolution of the monitor you are using. Refer to DIP Switch Settings in Appendix D.
Entire picture is not seen on the screen or it does not fill the entire screen	Misadjusted monitor.	Adjust the monitor width and height. Refer to the monitor manual. Use video screen adjustment in system tests.
	Game software screen size not at default setting	Adjust screen size in game side in Setup Menu> Trouble Shooting Shortcuts> Screen Size Adjustments
Red Screen: aspect ratio/screen resolution mismatch (16:9 aspect ratio)	DIP switch SW 202 on the I/O board set incorrectly.	Change SW202 DIP position 1 to ON
Red Screen: This is a 16:9 aspect ratio (Wide Screen Game)	Dip switches on the I/O board are set wrong.	Change SW202 DIP position 1 to ON and SW201 DIP settings to display 1280x720
	TV is not 16:9 aspect ratio	Use a wide screen TV
Entire boot sequence is observed and screen goes black after loading game message.	Dip Switches on SW 201 set incorrectly.	Adjust DIP Switch settings to match the resolution of the monitor you are using. Refer to I/O DIP Switch Settings in Appendix D.
	The DC power cable from the computer to the I/O board is not connected	Connect the I/O Power cable from the Computer to the I/O board. See Appendix D

Error Messages		
Symptom	Probable Cause	Solution
Most on screen error messages explain themselves.	Multiple	Follow the onscreen instructions. Many times turning the game off for ten seconds and then turning it back on will solve the error.
Flash code 6 on I/O Board Diode D102	CID is not connected or is defective	Check the USB cable connection. Swap with a known good cable. Call IT Service for further assistance.
Please turn game off, then connect Cabinet Identification Device (CID) then turn game back on.	CID is not connected	Connect CID to the Nighthawk System Box via USB cable.
	CID cable is defective	Try or swap with a known good USB cable.
	If LED is not flashing – Call I.T. Service	IT service will instruct you what to do.
Flash code 1 on I/O board diode D102	This indicates to USB connection fail from System Box to I/O Board.	Connect USB Cable.
Please turn game off, Then connect USB I/O board and then turn game back on.	USB cable is not connected	Connect the USB cable.
	USB cable is Defective	Try with a known good USB cable.
	I/O board has no power connection.	Verify power to the I/O board.
	I/O board is defective	Swap with a known good I/O board. Possibly bad. Call I.T. service.

Flash Code Messages		
Flash Code (I/O Diode D102)	Code Description	Solution
Flash code 2	This indicates to USB connection fail from System Box to I/O board.	Connect USB Cable.
Flash Code 3	INFO: Last reboot due to Watchdog time out.	Turn off game, wait 10 seconds, turn game on. If the problem persists call IT tech support.
Flash Code 4	Error when updating USB CID to latest version.	Turn off game, wait 10 seconds, turn game on. If the problem persists call IT tech support.
Flash Code 5	Updated USB CID was detected.	Turn off game, wait 10 seconds, turn game on. If the problem persists call IT tech support.
Flash code 6	CID is not connected or is defective	Check the USB cable connection. Swap with a known good cable. Call IT Service for further assistance.
Flash Code 7	CID Malfunction.	Make sure all connections are in place. Turn off game, wait 10 seconds, turn game on.
Flash Code 10	Error when updating USB I/O board to latest version.	Turn off game, wait 10 seconds, turn game on. If the problem persists call IT tech support.
Flash Code 11	Updated USB I/O board was detected.	Turn off game, wait 10 seconds, turn game on. If the problem persists call IT tech support.
Flash Code 12	I/O board is disconnected.	Make sure all connections are in place. Turn off game, wait 10 seconds, turn game on.
Flash Code 13	I/O board malfunction.	Make sure all connections are in place. Turn off game, wait 10 seconds, turn game on.
Flash Code 14	Incompatible I/O board.	Make sure all connections are in place. Turn off game, wait 10 seconds, turn game on.

Miscellaneous Problems		
Symptom	Probable Cause	Solution
Unable to exit Operator Menus.	Dipswitch SW202 position 4 is in the on position.	Set position 4 of SW202 to off. Press start to exit.
	Test switch wired from the I/O board is closed.	Verify satellite test switch is not closed.
Coin Meter is not working	Defective Coin Meter	Replace with a known good one.
	Not wired properly	Connect one lead to +5 or +12 volts depending on device. The other lead to coin meter on Service Panel Pin 2.
	Defective I/O board	Replace with a known good board.

APPENDIX B

INPUT/OUTPUT CONNECTIONS (I/O POWER, TRACKBALL, ETC.)

For Standard Online Kit and Deluxe Retrofit Kit

Trackball Harness Connector Pin Outs

I/O Board Connector	Trackball Connector
PIN WIRE #6 – Black	PIN WIRE #1 – Black
PIN WIRE #1 – Red	PIN WIRE #2 – Red
PIN WIRE #2 – Yellow	PIN WIRE #3 – Yellow
PIN WIRE #3 – Green	PIN WIRE #4 – Green
PIN WIRE #5 – Blue	PIN WIRE #5 – Blue
PIN WIRE #4 – Purple	PIN WIRE #6 – Purple

I/O Power Cable Pin Outs

Pin Number	Wire Color	Function
1	Yellow	+ 12 Volts DC
2	Black	Ground
3	Red	+ 5 Volts DC
4	Black	Ground

Control Panel J203 Connector Pin Outs

Pin	Color	Function
1	Green-White	Options
2	Brown-White	Left
3		No Connection
4	Yellow-White	Right
5	Violet-White	Flyby
6	Black	Volume GND
7	Black-White	Spin
8	Blue-White	Help
9	Red-White	Start
10	Black	Ground

Lamps J202 Connector Pin Outs

Pin	Color	Function
1	Red-Black	Lamp Power – Buttons
5	Red-Yellow	Help Lamp
6	Red-Green	Options Lamp

Speakers J301

Pin	Color	Function
1	Yellow-Red	Left Speaker +
2	Yellow-Green	Left Speaker -
3	White-Red	Right Speaker +
4	White-Green	Right Speaker -

Service Panel

Pin	Color	Function
1	Red-Black	Meter Power
2	Red-Green	Coin Meter
3	Orange-White	Volume Up
4	Orange-Yellow	Volume Down
5		No Connection
6	Blue	Test
7	Black	Test Ground

Coin Door J205

Pin	Color	Function
1	Red-Black	Lamp Power – Coin
2	Black	Lamp Ground – Coin
3		N.C.
4	Black	Bill Ground
5	Grey-White	Bill
6		No Connection
7		No Connection
8	Green-Blue	Coin 2
9	Red-Blue	Coin 1
10		No Connection
11	Black	Coin Ground

APPENDIX C REPLACEMENT PART NUMBERS

Please refer to these IT part numbers when placing orders.

Showpiece Part Numbers

Part Number	Description
925000369P	Showpiece, Golf Live 2021
900000304	Showpiece Stand for TV
900146007R	Cabinet Identification Device, Golf Live C.I.D. (Dongle)
902369000	I/O Board Assembly, Golf Live 2021, with wireless modem
900776369RA	System box, Golf Live 2021
753304004RB	Filter for system box
510000911R	Antenna, w/cable for wireless socket modem
999000715	Cash Vault Assembly, cash vault only
900938715	Cash Vault Sub-Assembly, GT Live security door w/Card Reader & DBA
760007104R	Card Reader
999000250	Bill Validator, MARS AE2681 (1/5/10/20) for I.T. security door
915003310R	Cable, USB, 3 ft
915015400R	Cable, HDMI, 15 ft
815000369	Manual, Golf Live 2021
820000369	Marquee, Golf Live 2021
900820369K-LM	Lighted Marquee Assembly – Golf Live 2021
751304115	Showpiece wing, right side
751304116	Showpiece wing, left side
740000004R	Speaker, 4 ohm
795000100	Wheel, Black, 3"
752304801R	Leg Leveler support plate for showpiece cabinet
795000150	Leg Leveler (Rubber base) for showpiece cabinet
880000030R	Trackball
885000030R	Trackball plate
850000001R	Pushbutton, Red
850000003R	Pushbutton, White
861000022R	Pushbutton, Blue Round Illuminated
861000025R	Pushbutton, Yellow Round Illuminated
900304012R1K	Keypad Kit for Golf Live
760304301	Wi-Fi Adapter
760304302	USB Hub

Online Kit Part Numbers

Please refer to these IT part numbers when placing orders.

Part Number	Description
925000369	KIT – STANDARD ONLINE GOLF LIVE 2021 U.S.
510000911R	ANTENNA W/CABLE FOR WIRELESS SOCKET MODEM
900325050	BAG SUB-ASSY, GOLF LIVE KIT
900146007R	BOARD ASSY, C.I.D., GOLF LIVE
902369000	BOARD ASSY, I/O, GOLF LIVE 2021 U.S. WITH WIRELESS MODEM MODULE
980000800	SHIPPING BOX, SYSTEM BOX KIT
915250304R	CABLE ASSEMBLY, I/O PWR/KIT, G-LIVE
915015400R	CABLE ASSEMBLY, HDMI, 15 FT
915000173R	CABLE ASSEMBLY, TRACKBALL/GUN INTERFACE
900300050	CABLE BAG SUB-ASSY FOR KITS WITH HDMI CABLES
999000060R	CARD READER BLANKING PLATE
900007104	CARD READER BEZEL (USB CABLE AND HARDWARE)
825100344R	CONTROL PNL, GOLF LIVE, DIECUT WITH CONTROL LABELS/TB HOLE
753304004RB	FILTER FOR SYSTEM BOX
915000234R	GROUND WIRE ASSEMBLY
815000369	MANUAL, GOLF LIVE 2021
820000369	MARQUEE, GOLF LIVE 2021
850000001R	PUSHBUTTON ASSY, RED WITH VERTICAL MOUNTED SWITCH
850000003R	PUSHBUTTON ASSY, WHITE WITH VERTICAL MOUNTED SWITCH
861000022R	PUSHBUTTON, BLUE ROUND ILLUM. W/SWITCH AND LED
861000025R	PUSHBUTTON, YELLOW ROUND ILLUM W/SWITCH AND LED
840775750	QUICK INSTALL, GOLF LIVE KIT
900775369RF	SYSTEM BOX, GOLF LIVE 2021
880000030R	TRACKBALL ASSY, 3" WHITE
885000030R	TRACKBALL PLATE FOR 3" TRACKBALL (WITH STANDOFFS)
915250308R	CABLE ASSEMBLY, INPUT/OUTPUT CONNECTIONS
900304012R1K	KEYPAD KIT FOR GOLF LIVE
900820369K-LM	LIGHTED MARQUEE ASSEMBLY, GOLF LIVE 2021
810007104R	LABEL FOR CARD READER: "INSERT PLAYER CARD HERE"
760007104R	CARD READER, MODEL 7104USB

APPENDIX D SYSTEM DIAGRAMS

Detailed Cable Connection Diagram

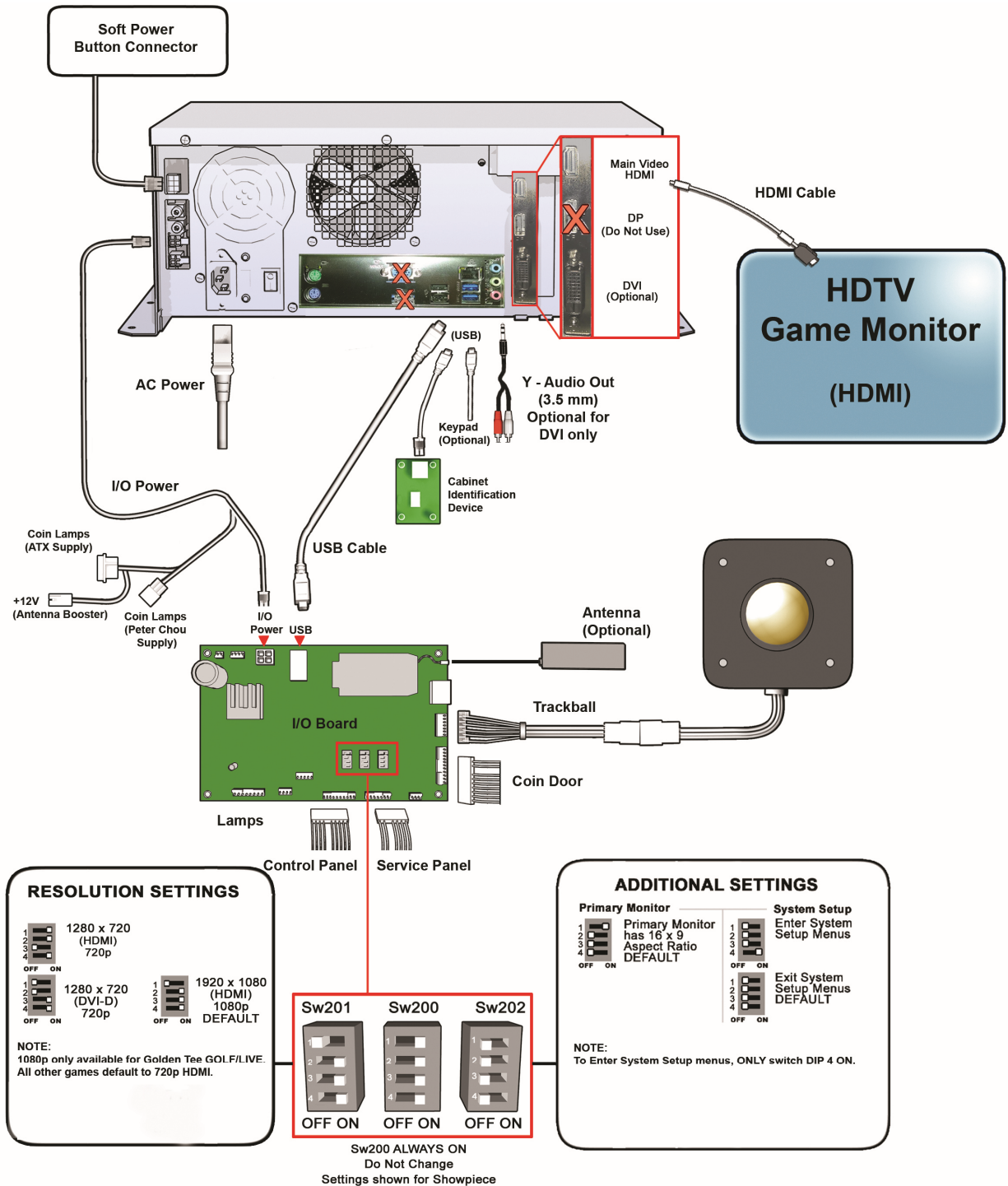

Nighthawk System Box Diagram

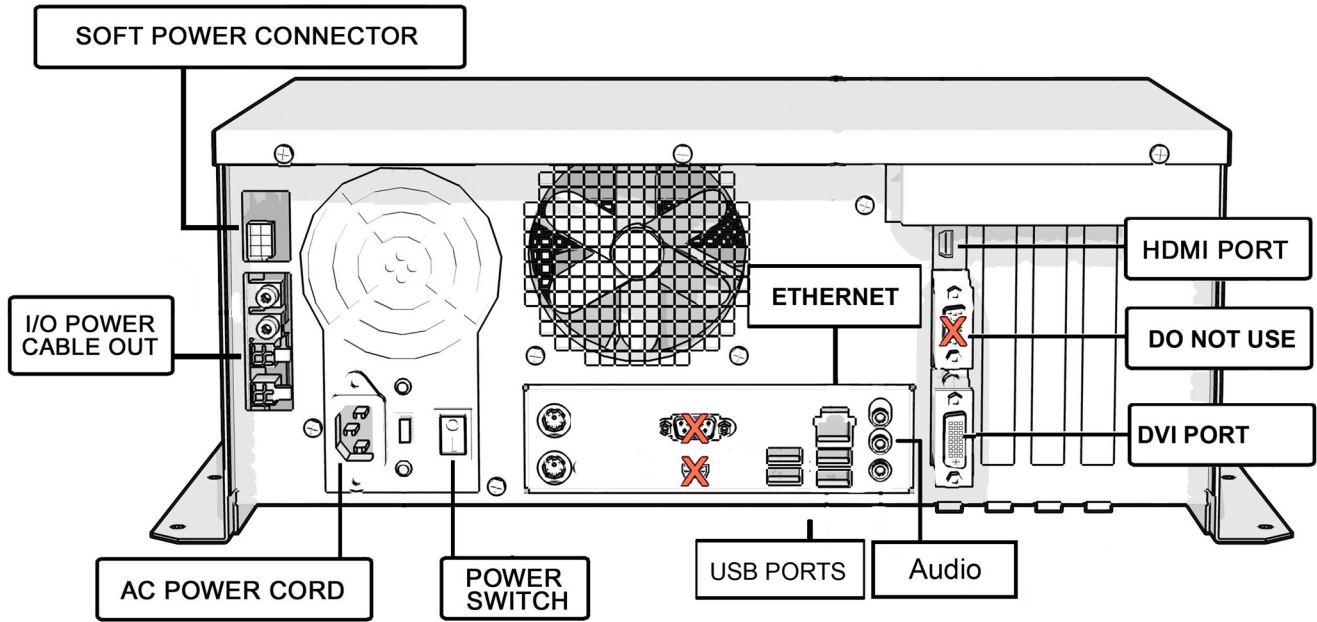

I/O Card Diagram

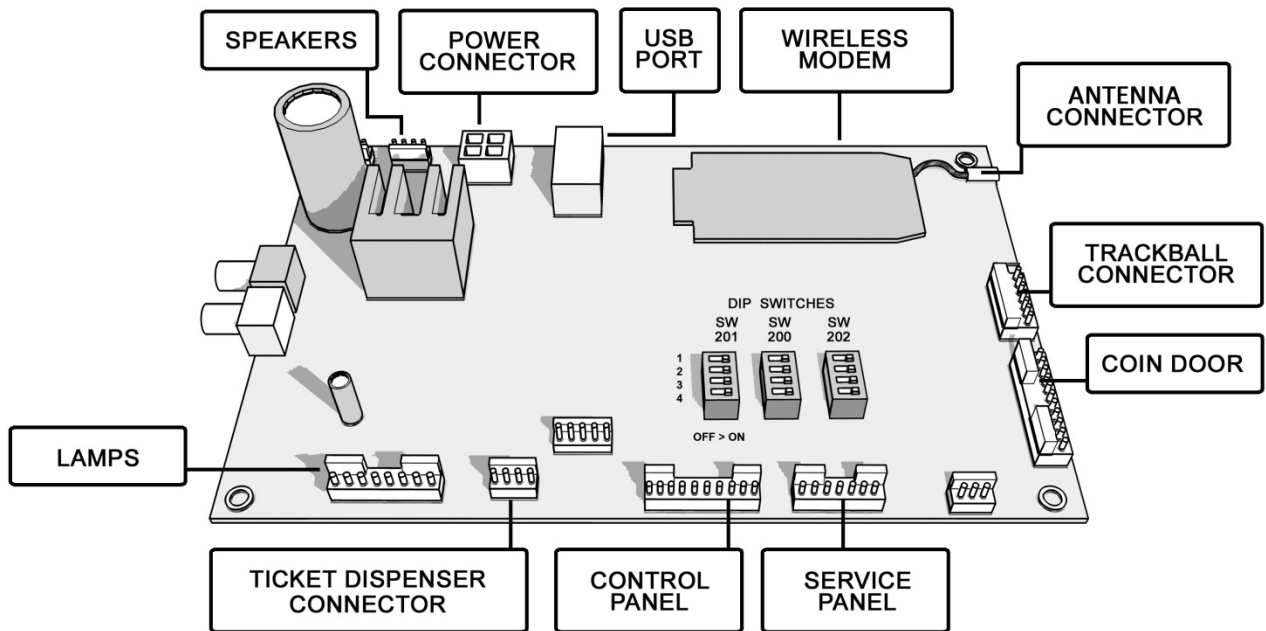

Video and I/O DIP Switch Settings for High Definition Televisions (HDTV)

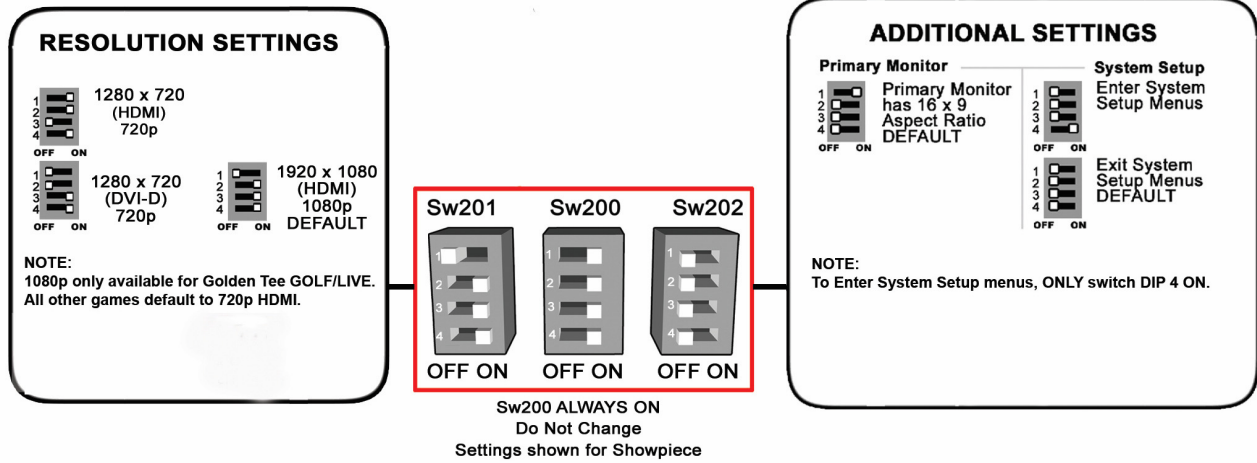

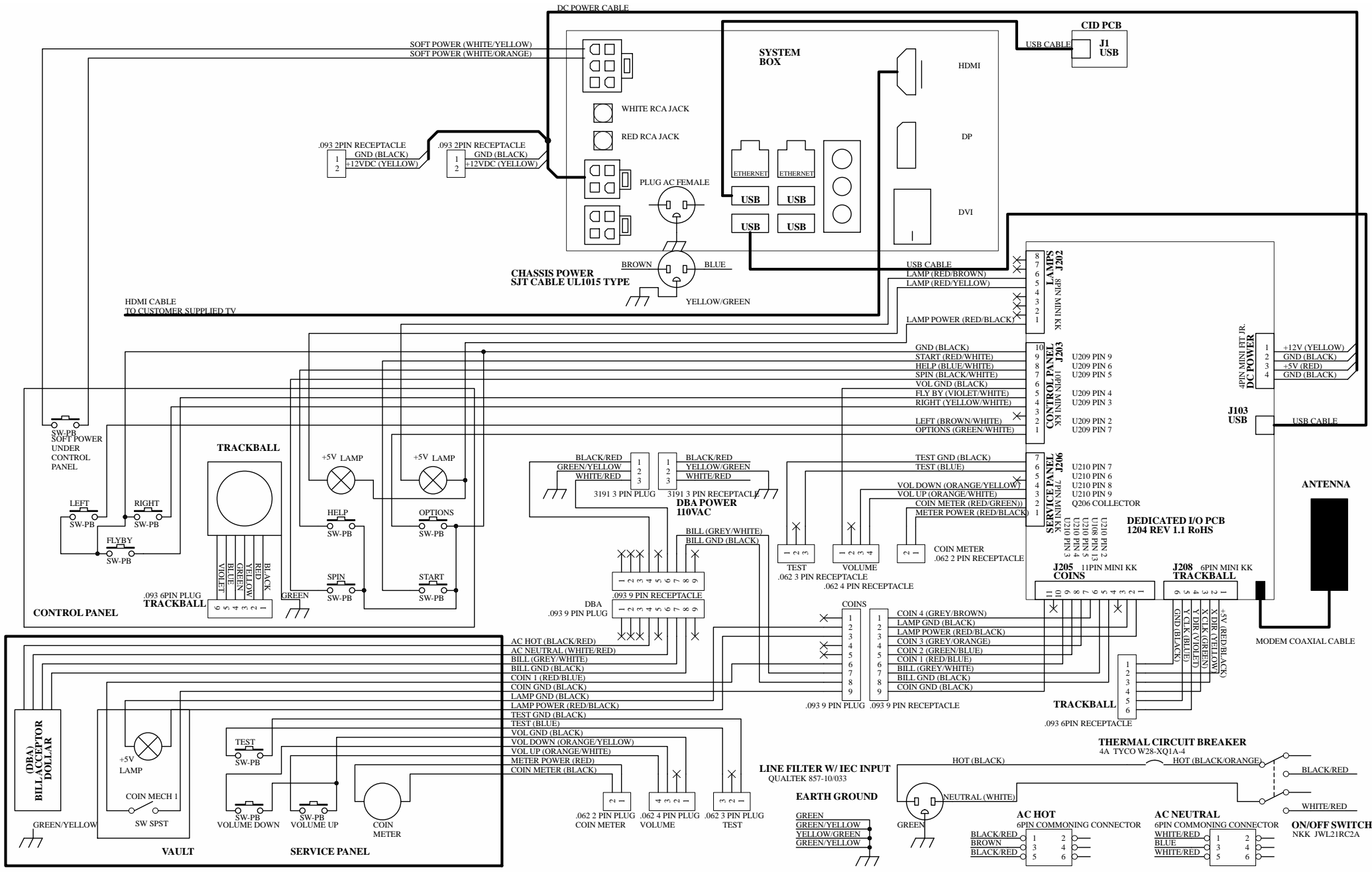

APPENDIX E

GNU GENERAL PUBLIC LICENSE

TERMS AND CONDITIONS FOR COPYING, DISTRIBUTION AND MODIFICATION

0. This License applies to any program or other work which contains a notice placed by the copyright holder saying it may be distributed under the terms of this General Public License. The "Program", below, refers to any such program or work, and a "work based on the Program" means either the Program or any derivative work under copyright law: that is to say, a work containing the Program or a portion of it, either verbatim or with modifications and/or translated into another language. (Hereinafter, translation is included without limitation in the term "modification".) Each licensee is addressed as "you".

Activities other than copying, distribution and modification are not covered by this License; they are outside its scope. The act of running the Program is not restricted, and the output from the Program is covered only if its contents constitute a work based on the Program (independent of having been made by running the Program). Whether that is true depends on what the Program does.

1. You may copy and distribute verbatim copies of the Program's source code as you receive it, in any medium, provided that you conspicuously and appropriately publish on each copy an appropriate copyright notice and disclaimer of warranty; keep intact all the notices that refer to this License and to the absence of any warranty; and give any other recipients of the Program a copy of this License along with the Program.

You may charge a fee for the physical act of transferring a copy, and you may at your option offer warranty protection in exchange for a fee.

2. You may modify your copy or copies of the Program or any portion of it, thus forming a work based on the Program, and copy and distribute such modifications or work under the terms of Section 1 above, provided that you also meet all of these conditions:

- a) You must cause the modified files to carry prominent notices stating that you changed the files and the date of any change.
- b) You must cause any work that you distribute or publish, that in whole or in part contains or is derived from the Program or any part thereof, to be licensed as a whole at no charge to all third parties under the terms of this License.
- c) If the modified program normally reads commands interactively when run, you must cause it, when started running for such interactive use in the most ordinary way, to print or display an announcement including an appropriate copyright notice and a notice that there is no warranty (or else, saying that you provide a warranty) and that users may redistribute the program under these conditions, and telling the user how to view a copy of this License. (Exception: if the Program itself is interactive but does not normally print such an announcement, your work based on the Program is not required to print an announcement.) These requirements apply to the modified work as a whole. If identifiable sections of that work are not derived from the Program, and can be reasonably considered independent and separate works in themselves, then this License, and its terms, do not apply to those sections when you distribute them as separate works. But when you distribute the same sections as part of a whole which is a work based on the Program, the distribution of the whole must be on the terms of this License, whose permissions for other licensees extend to the entire whole, and thus to each and every part regardless of who wrote it.

Thus, it is not the intent of this section to claim rights or contest your rights to work written entirely by you; rather, the intent is to exercise the right to control the distribution of derivative or collective works based on the Program.

In addition, mere aggregation of another work not based on the Program with the Program (or with a work based on the Program) on a volume of a storage or distribution medium does not bring the other work under the scope of this License.

3. You may copy and distribute the Program (or a work based on it, under Section 2) in object code or executable form under the terms of Sections 1 and 2 above provided that you also do one of the following:

- a) Accompany it with the complete corresponding machine-readable source code, which must be distributed under the terms of Sections 1 and 2 above on a medium customarily used for software interchange; or,
- b) Accompany it with a written offer, valid for at least three years, to give any third party, for a charge no more than your cost of physically performing source distribution, a complete machine-readable copy of the corresponding source code, to be distributed under the terms of Sections 1 and 2 above on a medium customarily used for software interchange; or,
- c) Accompany it with the information you received as to the offer to distribute corresponding source code. (This alternative is allowed only for noncommercial distribution and only if you received the program in object code or executable form with such an offer, in accord with Subsection b above.)

The source code for a work means the preferred form of the work for making modifications to it. For an executable work, complete source code means all the source code for all modules it contains, plus any associated interface definition files, plus the scripts used to control compilation and installation of the executable. However, as a special exception, the source code distributed need not include anything that is normally distributed (in either source or binary form) with the major components (compiler, kernel, and so on) of the operating system on which the executable runs, unless that component itself accompanies the executable.

If distribution of executable or object code is made by offering access to copy from a designated place, then offering equivalent access to copy the source code from the same place counts as distribution of the source code, even though third parties are not compelled to copy the source along with the object code.

4. You may not copy, modify, sublicense, or distribute the Program except as expressly provided under this License. Any attempt otherwise to copy, modify, sublicense or distribute the Program is void, and will automatically terminate your rights under this License. However, parties who have received copies, or rights, from you under this License will not have their licenses terminated so long as such parties remain in full compliance.

5. You are not required to accept this License, since you have not signed it. However, nothing else grants you permission to modify or distribute the Program or its derivative works. These actions are prohibited by law if you do not accept this License. Therefore, by modifying or distributing the Program (or any work based on the Program), you indicate your acceptance of this License to do so, and all its terms and conditions for copying, distributing or modifying the Program or works based on it.

6. Each time you redistribute the Program (or any work based on the Program), the recipient automatically receives a license from the original licensor to copy, distribute or modify the Program subject to these terms and conditions. You may not impose any further restrictions on the recipients' exercise of the rights granted herein. You are not responsible for enforcing compliance by third parties to this License.

7. If, as a consequence of a court judgment or allegation of patent infringement or for any other reason (not limited to patent issues), conditions are imposed on you (whether by court order, agreement or otherwise) that contradict the conditions of this License, they do not excuse you from the conditions of this License. If you cannot distribute so as to satisfy simultaneously your obligations under this License and

any other pertinent obligations, then as a consequence you may not distribute the Program at all. For example, if a patent license would not permit royalty-free redistribution of the Program by all those who receive copies directly or indirectly through you, then the only way you could satisfy both it and this License would be to refrain entirely from distribution of the Program.

If any portion of this section is held invalid or unenforceable under any particular circumstance, the balance of the section is intended to apply and the section as a whole is intended to apply in other circumstances.

It is not the purpose of this section to induce you to infringe any patents or other property right claims or to contest validity of any such claims; this section has the sole purpose of protecting the integrity of the free software distribution system, which is implemented by public license practices. Many people have made generous contributions to the wide range of software distributed through that system in reliance on consistent application of that system; it is up to the author/donor to decide if he or she is willing to distribute software through any other system and a licensee cannot impose that choice.

This section is intended to make thoroughly clear what is believed to be a consequence of the rest of this License.

8. If the distribution and/or use of the Program is restricted in certain countries either by patents or by copyrighted interfaces, the original copyright holder who places the Program under this License may add an explicit geographical distribution limitation excluding those countries, so that distribution is permitted only in or among countries not thus excluded.

In such case, this License incorporates the limitation as if written in the body of this License.

9. The Free Software Foundation may publish revised and/or new versions of the General Public License from time to time. Such new versions will be similar in spirit to the present version, but may differ in detail to address new problems or concerns.

Each version is given a distinguishing version number. If the Program specifies a version number of this License which applies to it and "any later version", you have the option of following the terms and conditions either of that version or of any later version published by the Free Software Foundation. If the Program does not specify a version number of this License, you may choose any version ever published by the Free Software Foundation.

10. If you wish to incorporate parts of the Program into other free programs whose distribution conditions are different, write to the author to ask for permission. For software which is copyrighted by the Free Software Foundation, write to the Free Software Foundation; we sometimes make exceptions for this. Our decision will be guided by the two goals of preserving the free status of all derivatives of our free software and of promoting the sharing and reuse of software generally.

NO WARRANTY

11. BECAUSE THE PROGRAM IS LICENSED FREE OF CHARGE; THERE IS NO WARRANTY FOR THE PROGRAM, TO THE EXTENT PERMITTED BY APPLICABLE LAW. EXCEPT WHEN OTHERWISE STATED IN WRITING THE COPYRIGHT HOLDERS AND/OR OTHER PARTIES PROVIDE THE PROGRAM "AS IS" WITHOUT WARRANTY OF ANY KIND, EITHER EXPRESSED OR IMPLIED, INCLUDING, BUT NOT LIMITED TO, THE IMPLIED WARRANTIES OF MERCHANTABILITY AND FITNESS FOR A PARTICULAR PURPOSE. THE ENTIRE RISK AS TO THE QUALITY AND PERFORMANCE OF THE PROGRAM IS WITH YOU. SHOULD THE PROGRAM PROVE DEFECTIVE, YOU ASSUME THE COST OF ALL NECESSARY SERVICING, REPAIR OR CORRECTION.

12. IN NO EVENT UNLESS REQUIRED BY APPLICABLE LAW OR AGREED TO IN WRITING WILL ANY COPYRIGHT HOLDER, OR ANY OTHER PARTY WHO MAY MODIFY AND/OR REDISTRIBUTE THE PROGRAM AS PERMITTED ABOVE, BE LIABLE TO YOU FOR DAMAGES, INCLUDING ANY GENERAL, SPECIAL, INCIDENTAL OR CONSEQUENTIAL DAMAGES ARISING OUT OF THE USE OR INABILITY TO USE THE PROGRAM (INCLUDING BUT NOT LIMITED TO LOSS OF DATA OR DATA BEING RENDERED INACCURATE OR LOSSES SUSTAINED BY YOU OR THIRD PARTIES OR A FAILURE OF THE PROGRAM TO OPERATE WITH ANY OTHER PROGRAMS), EVEN IF SUCH HOLDER OR OTHER PARTY HAS BEEN ADVISED OF THE POSSIBILITY OF SUCH DAMAGES.

How to Apply These Terms to Your New Programs If you develop a new program, and you want it to be of the greatest possible use to the public, the best way to achieve this is to make it free software which everyone can redistribute and change under these terms.

To do so, attach the following notices to the program. It is safest to attach them to the start of each source file to most effectively convey the exclusion of warranty; and each file should have at least the "copyright"

line and a pointer to where the full notice is found.

One line to give the program's name and an idea of what it does.

Copyright (C) yyyy name of author

This program is free software; you can redistribute it and/or modify it under the terms of the GNU General Public License as published by the Free Software Foundation; either version 2 of the License, or (at your option) any later version.

This program is distributed in the hope that it will be useful, but WITHOUT ANY WARRANTY; without even the implied warranty of MERCHANTABILITY or FITNESS FOR A PARTICULAR PURPOSE. See the GNU General Public License for more details.

You should have received a copy of the GNU General Public License along with this program; if not, write to the Free Software Foundation, Inc., 59 Temple Place - Suite 330, Boston, MA 02111-1307, USA.

Copyright 2004 Incredible Technologies, Inc. (IT). Certain programs, identified at IT's Website are free software subject to an associated license.

1. Because certain programs are licensed free of charge, see IT's website, there is no warranty for such programs to the extent permitted by applicable law. Except when otherwise stated in writing the copyright holders and/or other parties provide those programs "as is" without warranty of any kind, either expressed or implied, including, but not limited to, the implied warranties of merchantability and fitness for a particular purpose. The entire risk as to the quality and performance of those programs is with you. Should the programs prove defective, you assume the cost of all necessary servicing, repair or correction.

2. In no event unless required by applicable law or agreed to in writing will any copyright holder, or any other party who may modify and/or redistribute those programs be liable to you for damages including any general, special, incidental or consequential damages arising out of the use or inability to use those programs (including but not limited to loss of data or data being rendered inaccurate or losses sustained by you or third parties or a failure of those programs to operate with any other programs), even if such holder or other party has been advised of the possibility of such damages.

A complete machine-readable copy of the source code of those programs and associated license is available to any third party, at the IT website.

APPENDIX F INFORMATIONAL GUIDES

WIRELESS SIGNAL STRENGTH AND ANTENNA GUIDE

Understanding the basics of wireless antennas and the wireless frequency can help to improve your game's signal strength and reliability.

In a perfect world the tower antenna and the machine's antenna are in perfect phase with one another, and close enough in proximity that the strength is very good. In the real world the environment will change the phase of the signal and reduce its strength. Buildings, walls, metal or concrete, and even cars outside can affect the reflection of wireless signals. Basically, everything between the tower and the game will have some sort of effect.

The antenna in Golden Tee LIVE is designed to "see" the wireless signal equally from any direction. However, because objects in the machine's surroundings can affect the signal, the antenna may accept a better signal if it is moved a few inches from its original position, inverted, or rotated 45-to-180 degrees. There is no exact science to finding the optimal signal, so some locations may require some testing to get the best possible results.

Note: Do not position the antenna horizontally.

When testing the wireless signal strength, go to *ITNet Settings/Communication Settings* in the System Setup menus. Use tape or Velcro to temporarily position the antenna into a new location, and let it settle for at least 30 seconds. Note the antenna's current position and signal strength reading on the screen. Then try another location or orientation and note the results. The best location for the antenna can usually be found using this procedure. Once you find the optimal spot, affix the antenna using double sided tape. Remember that fewer obstacles between the antenna and the tower is your goal, and often that means that height is not always better.

A signal reading of 20 is adequate as long as there are not large or noticeable shifts in the signal strength (dipping into *Low Signal*). A signal reading of 25 to 50 is optimal; a great signal is anything above 50. Each location is different, and these characteristics can often change if the surroundings change. It is a good idea to check the signal strength test with every collection to see if you are continuing to get the optimal signal position.

COLLECTIONS GUIDE

Golden Tee LIVE is a revolutionary product that requires some special handling when making a collection. Follow these steps every time you make a collection to make sure your profits and payments are managed properly.

Step 1: Collect your Cash Box

Open the coin vault and collect the cash and bills. Count it carefully and note the total.

Step 2: Review the Collection Screen

Remember that there are various fees and charges associated with some Golden Tee LIVE features, so it is important to compare the total cash you collect to the Collection Screen in the game. Open the outer door of the cash vault and press the System Setup button to enter the System Setup Menus. Select **Collections and Earnings**, and then **Do Collection**. The machine will attempt to contact ITNet for complete and updated data.

If an error occurs, back out of the collection menus and try the process again. If the machine is unable to contact ITNet, an estimated collection will be presented. This estimate will be close to accurate, and should allow you to complete the collection. Any discrepancies will be reconciled once the machine is able to connect properly.

This process takes you to the main collection screen. You should familiarize yourself with this screen, and how the information is displayed. These figures will help you determine how much to give to the location.

Note the date range and number of days in operation. If used properly, these fields should match with your collection dates. They are also important for calculating some of the various monthly fees.

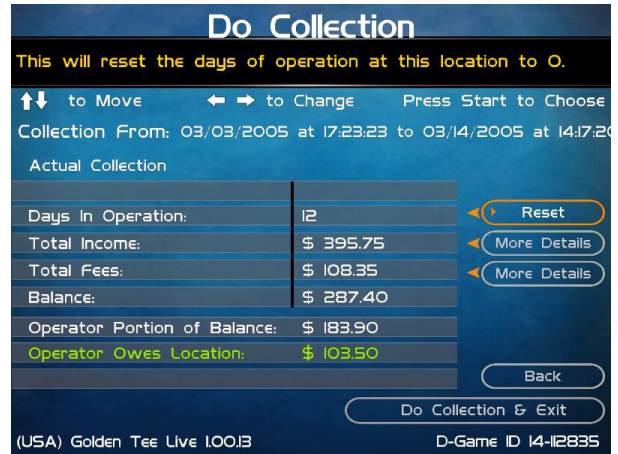

Review the **Total Income** and **Total Fees** columns to see how much money your machine made for this time period, and how much is owed for various fees for this time period.

Total Income includes income from Cash, Player Wallet, Credit Card purchases, and various Promotional or Gift Cards. Note that games paid by anything other than cash will NOT be in your cashbox, and will instead be credited to you on your ITNet statement. **THIS MEANS THAT YOUR CASHBOX WILL NOT MATCH YOUR TOTAL INCOME.** Select **More Details** to view a breakdown of cash, player account, gift card and credit card income.

To verify the Operator and Location portions, first divide Total Income by the correct split percentage to get the operator and location portions of income. Then divide Total Fees by its split percentage to get both portions of the fees. Then subtract each fee portion from the income portion to get the final operator and location portions.

Total Fees include ITNet fees, money for the Prize Fund, Communication fees, Credit Card fees, Software Update fees and Hardware Upgrade fees. Note that Software Update Fees and Hardware Update Fees are included for your convenience, to help you cover the costs of owning and operating your equipment. These two line items are NOT included on your monthly ITNet statement, but give you a great opportunity to split some of these costs with the location. The **Balance** column displays the Total Income minus the Total Fees, giving you a realistic total of income for this time period.

Step 3: Pay the Location

Operator Portion of Balance is the amount of the collection that you keep. Operator Owes Location is the amount of the collection that you pay your location. These amounts are determined by the split percentages set in the Collection Settings menus. In some extreme cases, there may not be enough money in the cash box to cover the location portion. **It is highly recommended that you do your best to pay the location at the time of the collection, as any missing funds will be reconciled during the monthly ITNet billing.**

Step 4: Reset the Collection Screen

It is highly recommended that you reset these audit screens after every collection. When you have finished reviewing the information, highlight **Do Collection and Exit** and press Start. This will set all of the fields in the **Do Collection** screen to zero. Be sure to empty your cash box at the same time, so these screens will match the money at your next collection.

INCOME SPLIT GUIDE

Golden Tee LIVE is a revolutionary product that offers a variety of ways to pay for game play, including credit cards, player wallet and gift cards. There are also some fees associated with the operation of Golden Tee LIVE. The operator/location split on many of these income and fee settings can be individually adjusted, allowing you to fine tune your costs and maximize your profits.

To access the Collection Settings menus, open the outer door of the cash vault and press the System Setup button to enter the System Setup Menus. Select **General Settings**, then **Operator Adjustables**, then **Collection Settings**. The four available categories are: Hardware Update Fee, Income Splits, Fee Splits, and Tax Settings.

Set Hardware Update Fee

This menu allows you to adjust the Hardware Update Fee. This fee is included for your convenience, as a method to have the location pay for part of your equipment. The default value is \$0.00 per week. Use this menu to adjust this value up or down. The weekly amount will be calculated on a per day basis, and added in to the **Total Fees** field on the **Do Collection** screen. Note that the Hardware Update Fee is included for your convenience; it is not an actual fee and is NOT included on your monthly ITNet statement.

Operator/Location Income Splits

Use this menu to fine-tune your splits for income generated from Cash, Player Wallet, Credit Card, ITNet Money Card, and Operator Money Card payments. Since there may be times when you have to pay the location before you actually have the cash in hand, you may want to adjust the split in your favor to cover the waiting period. The default settings are displayed on the accompanying screen.

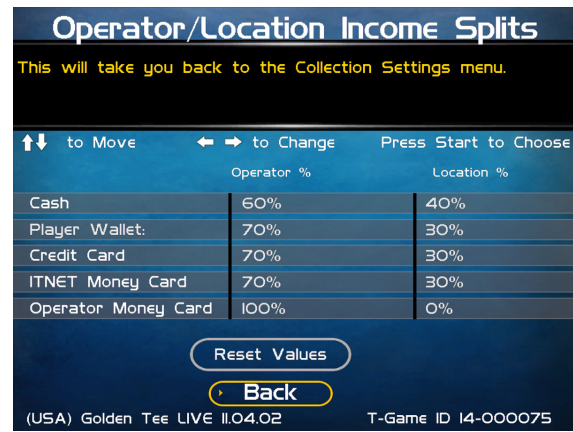

Operator/Location Fee Splits

Use this menu to determine how you wish to split the various fees associated with Golden Tee LIVE, including ITNet Fees, Prize Fund Fees, Credit Card Fees, Communication Fees, Software Update Fees and Hardware Update Fees. The location is benefiting from your game by increasing food and beverage sales and creating loyal patrons. Setting some of these splits in your favor will help you to cover your costs in a fair and equitable manner. The default settings are displayed on the accompanying screen.



Tax Settings

Many states require special taxes or license fees that affect your bottom line. Use this menu to account for these costs in your collection.

In these menus, you can set the Tax Rate percentage, the Tax Type, meaning what part of the collection is taxed and who pays for these taxes, and the Tax Split for how to share these fees with your location.

Incredible Technologies hopes that you will take advantage of these menus to maximize your earnings potential.

PLAYER WALLET GUIDE

Golden Tee LIVE offers a revolutionary Play for Prizes contest format that allows players from all over the world to compete for cash with every game they play. In most cases, prizes are awarded immediately following the completion of each contest, via a credit to special ITNet Player Wallet.

Player Wallets are available to the individual players directly through a Golden Tee LIVE machine. That means that the players can easily use their winnings to play more games of Golden Tee LIVE. Now, instead of getting a check in the mail and spending the winnings away from the game or location, the majority of players are using their winnings to play more Golden Tee LIVE games, thus putting their winnings right back into the machine. This is a huge benefit to both the location and operator, because it keeps people in their seats, eating and drinking and playing Golden Tee. Operators can look at this reinvestment as found money, and a brand new source of revenue.

When a player pays for his game using his Player Wallet, he is not putting cash directly into the coin box. This means that the game revenue in a normal collection cycle will typically exceed the actual cash in the game. Therefore it is very important to familiarize yourself with the Golden Tee LIVE collection menus and procedures, and your monthly ITNet billing statement.

When the player uses this Player Wallet money to play more Golden Tee, ITNet credits the full amount to the appropriate operator. These credits will appear on your regular monthly ITNet statement, and will mean a lower ITNet bill, or sometimes even a credit to your bank account!

You are encouraged to pay the location portion in full at each collection, to avoid additional accounting on your part. While there might be a delay before you get your money back from ITNet, it will simplify the process immensely if you can manage the location up front. The operator/location split percentage has been set in your favor at 70/30 for Player Wallet income, since you must wait for your portion. Use this as a selling tool to adjust the collection in your favor.

The Collection Menu on Golden Tee LIVE details the various income sources for your review. You are encouraged to spend some time with these screens so you understand where your revenue is being generated. You should also log in regularly to your Operator Services account on itsgames.com, to check on the performance of your equipment and check to see if the cash in the cash box will be enough to cover the split with your location.

- ◆ Skill based Play for Prizes adds an additional revenue source with huge potential
- ◆ Winners are encouraged to reinvest their winnings back to Golden Tee LIVE
- ◆ Entry Fees and Player Wallet Play must be collected and distributed by ITNet first
- ◆ The Player Wallet default split percentage is factory set to the operator's advantage
- ◆ Use the Collection Screen to set aside the various game fees, including Prize Pool money, and determine the location split
- ◆ Pay the location portion at the time of collection if at all possible
- ◆ Each month ITNet will issue a credit to your bill for Player Wallet activity on your machines.
- ◆ In some cases this additional revenue and resulting credit will cover or surpass your fees, in which case ITNet will credit your bank account.

GOLDEN TEE LIVE REVENUE GUIDE

Revenue Types - With GT LIVE, cash is now not your only source of income. You can't just count up the cash, deduct the fees and split the rest. Players can now play games with cash as well as 5 other revenue types. The different types of revenue are:

- Cash
- Player Wallet
- Credit Cards
- IT Gift cards
- Operator gift cards
- Operator free cash

Cash – Is just that; coin and currency. This is the only revenue that will appear on your hard meter, since it is counting physical pulses from the coin mechanisms and bill validator.

Player Wallet – This is the revenue earned when a player plays games with their “Play for Prizes” winnings. Players can still request a check for their winnings on the IT website, but most are rolling it right back into your game.

Credit Cards – This is revenue earned when a player pays by credit or debit card. GT LIVE currently accepts Visa and MasterCard.

IT Gift Cards – This is revenue earned when a player swipes his gift card to pay for a game. IT Gift cards are purchased through us directly and shipped either to the purchaser or the recipient of the gift. This is similar to a Wal-Mart or Best Buy gift card.

Operator gift cards – These are cards you can purchase for the cost of the plastic. You request whatever denomination you want. We will print the cards with your logo and artwork. You can give these out for promotions or refunds. Players will only be able to use them on machines registered to your account.

Operator free cash – This is the dollar value of games played using Operator free cash. These are credits you can put on your game for free play. This is intended for use if you want to test a game or set up a certain dollar amount of free play for promotional purposes, such as an open house.

ACCOUNTING FOR THE VARIOUS REVENUE TYPES

Cash – The GT Live machines are factory set to give you 60% and the location 40% of the cash.

Player account, Credit card and IT Gift revenue - Since this is revenue to you, but you do not have the cash in hand at the point of collection, you will get your money on your ITNet billing statement as a credit in a column titled “Due from IT.” You'll need to pay your location on collection day and wait to receive this revenue until your next statement, so you are basically fronting this revenue type to your locations. Because of this, the machines are factory set to give you 70% of this revenue and the location 30%. That extra 10% of the cash split that you're taking will help cover the 30% you're fronting.

Operator gift cards and Operator free cash – Operator gift cards and Operator free cash are a way to promote your GT Live without splitting this “Revenue” with your locations. This is accounted like non-revenue or free play. This revenue is set to give you 100% and the location 0%. Please note that any fees incurred from this revenue still apply.

Please note all the revenue and fee settings can be changed to whatever split percentage you want, for each type of revenue source.

GOLDEN TEE LIVE FEES

Fee Types – The 6 different fee types are as follows:

- ITNet Fees
- Credit Card fees
- Communication fees
- Prize Pool/Fund
- Software Update fees (operator benefit)
- Hardware Update fees (operator benefit)

ITNet portion – This is what is paid to IT for administering a LIVE game or the purchase of virtual balls and equipment. For every LIVE game the ITNet portion is \$0.35. IT is also paid half of the cost when a player purchases premium balls, Golden Tees or clubs, or paid YouTube™ shots. The player cost schedule below breaks out these fees.

Play Choice	Total to Player	Operator Portion	ITNet Portion	Prize Fund
Daily Contest	\$5.00	\$3.65	\$0.35	\$1.00
18-Hole LIVE	\$4.00	\$3.65	\$0.35	0
18-Hole Stats Play	\$4.00	\$3.65	\$0.35	0
18-Hole for Prizes	\$5.00	\$3.65	\$0.35	\$1.00
Closest to the Pin LIVE	\$2.00	\$0.90	\$0.10	\$1.00
Closest to the Pin Online	\$1.00	\$0.90	\$0.10	0
Closest to the Pin Casual	\$1.00	\$0.90	\$0.10	0
Casual (18 hole)	\$4.00	\$3.65	\$0.35	0
Mulligan	\$0.25	\$0.25	0	0
Hole-N-Win Par 3	\$0.50	0	\$0.50	IT Funded
Hole-N-Win Par 4	\$1.00	0	\$1.00	IT Funded
Virtual Golf Clubs	\$2.00	\$1.00	\$1.00	0
Virtual Golf Balls	\$0.50	\$0.25	\$0.25	0
Bag of 10 Golden Tees	\$0.50	\$0.25	\$0.25	0
Bag of 25 Golden Tees	\$1.00	\$0.50	\$0.50	0
Bag of 60 Golden Tees	\$2.00	\$1.00	\$1.00	0
Paid YouTube™ Shots	\$0.50	\$0.25	\$0.25	0
Money Shot	\$1.00	\$0.40	\$0.10	\$0.50
Money Shot 6 Play	\$5.00	\$2.00	\$0.50	\$2.50
Real Time Rival	\$4.00	\$3.65	\$0.35	0
Events Mode	\$5.00	\$3.65	\$0.35	0

Credit Card fees – When a player opts to pay by a credit card, there will be a merchant fee associated with this charge. The fee comes to just under 2% plus a per-transaction fee. When this transaction fee is rolled back in with the 2% fee, your actual percentage rate ends up being around 7.2%. This may look high, but for a micro transaction this is low.

For example a normal purchase of \$100.00 is made on a credit card. Add the 2% plus a \$0.30 per transaction fee. It comes to \$2.30 or 2.3%. Do this same transaction with a \$4.00 purchase. You would add the 2% (\$0.08) to the per-transaction fee of \$0.30 and you get \$0.38. This works out to 9.5%.

Communication fees – There is a communication fee for the use of the Sprint wireless service on the game. The Sprint charge is \$0.50 per day or \$15 per month. It does not matter if your game uses 500 or 5000 minutes per month, the rate stays the same. Please note that if you have Ethernet capability at your location, simply plug it in and your modem will automatically be disabled. You will also no longer be billed for communication fees.

Prize Pool/Fund– When players enter a LIVE game, they are asked if they want to play for prizes. This will not occur if your game is in a state that does not allow Live for Prize Play or if you disable Live for Prize Play on your machine. If the player opts to play for prizes (money), they are asked to pay an additional dollar. The prize fund money can be accounted as pass-thru money. This fee will appear on your ITNet statement, since IT collects these entry dollars from you, and disperses them to the winners through their player wallet.

Software Update fees – Down the road when you purchase new courses for your live game this will give you the opportunity to split the cost of your new courses with your location. It is handled much like the Hardware Update fee, described next.

Hardware Update fee – This Hardware Update fee is for you and you alone. You will NEVER BE BILLED for this fee. Operators have been asking for a place where they could recoup extra costs (should they so desire) from their locations. The default weekly fee is set to \$0.00. If you were to change the default setting to \$29 per week on your machine, you will have recouped half the cost of your LIVE game from your location in 4 years. Many operators use this feature for other purposes. It can be used in certain locations where a weekly minimum is required. It can also be used for a weekly contest participation fee. The dollar amount of this fee can be changed to whatever dollar amount you want. The percentage split may also be adjusted.

ACCOUNTING FOR FEES

All of the fees above are factory set to split 50/50. The collection will take the different revenue types and calculate the different percentage splits, then take the different fees and calculate their split percentages. The fees will be deducted from the revenue and a dollar value is given to you and to your location. These values are shown on the collection screens in System Setup mode.

COLLECTIONS

GT Live Collection Screen – The first thing you will see is the collection From ... to ... dates. Just below that you will either see “Estimated Collection” or “Actual Collection.” If you see “Estimated Collection” there was a problem getting a connection to our servers. We strongly suggest you back out without collecting and then go right back in to try to connect again. Nine times out of ten you should get an actual reading.

In the gray boxes, you will see the line item “days of operation.” This is the number of days since your last collection screen was cleared. You will see the total income, total fees, balance, operator portion of balance and operator owes location numbers. Since cash is no longer your only source of revenue, it is very important to view the details of the total income. To get these numbers, simply move the trackball up to the “More Details” blue box located directly to the right of the total income dollar value. Click your start button and you will be into the revenue breakdown page.

This screen shows a line item for each type of revenue source. This is where you can compare your cash on screen to your cash in hand. You can then go back to the main collection screen and do the same for your total fees. When you are done viewing all your numbers, click on the “Do Collection and Exit” button. The game will then send the collection data to your secure operator services web page for viewing at your office.

The next page is a sample GT LIVE collection sheet, showing the different revenue and income. This also shows the default percentages of the various split settings. You may want to take this form with you to your collections until you are comfortable with the system.



Collection Worksheet

Location _____ CID _____

From ___/___/___ to ___/___/___

Collector _____

Total Income \$ _____

Cash _____ (Default 60% Operator/40% Location)

Player Wallet (Due from IT) _____ (Default 70%/30%)

IT Gift Cards _____ (Default 70%/30%)

Credit Cards _____ (Default 70%/30%)

Operator Free Cash _____ (Default 100%/0%)

Operator Gift Cards _____ (Default 100%/0%)

Total Fees \$ _____

ITNet Fees _____ (\$0.35 p/ Live game; 50% of balls & clubs, Hole-N-Win, CTPP LIVE, paid YouTube)

Prize Fund _____ (\$1.00/\$0.50 for Money Shot)

Communication Fee _____ (\$0.50 per day; or \$15 per month)

Hardware Update Fee _____ (adjustable by the operator; not charged by IT)

Credit Card Fees _____ (7.2%)

Software Update Fees _____ (will activate with new courses)

Net to Split \$ _____ / _____
 Operator portion / Location Portion

GT LIVE COLLECTION PROCEDURE

Follow this step-by-step visual guide to aid in proper collections on your machines. Refer to the Collections Guide in your manual for more helpful information.

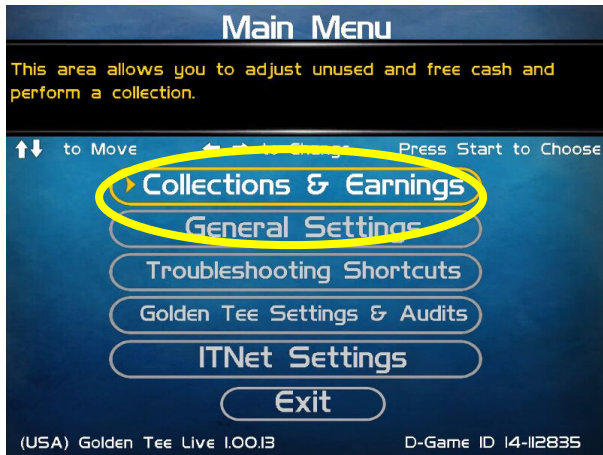

Press the System Setup button inside the coin door to access the System menus.

Use the trackball to highlight **Collections & Earnings** and press the Start button.

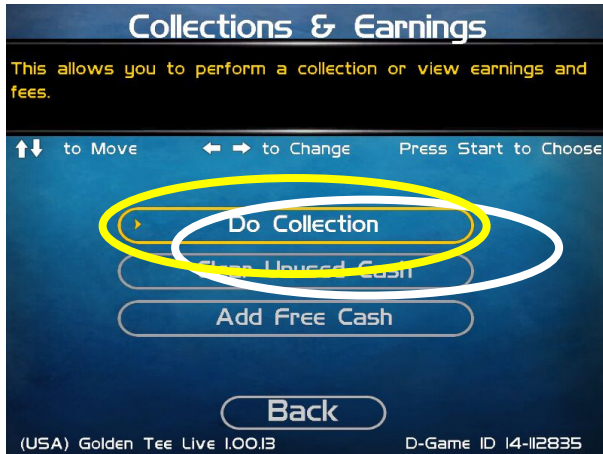

From the Collections & Earnings Menu, highlight **Do Collection** and press the Start Button. The game will connect with ITNet and gather the most current financial data.

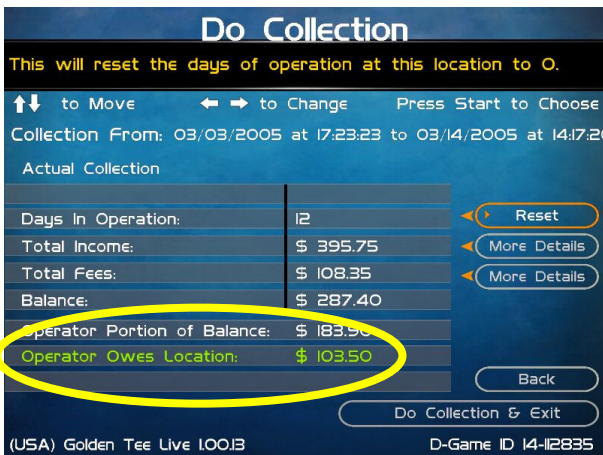

Note: Make sure that the top of the screen reads Actual Collection. If it reads Estimated Collection, the collection will not be accurate. It is possible the game is offline. In general, if the operator exits without recording and re-enters, the screen will then read Actual Collection.

Look at the dollar amount beside Operator Owes Location. This is the location portion that should be paid at the time of the collection. Due to the various alternative payment options this number will NOT match the cash in the coinbox. However, it is a good idea to pay the location its share at the time of collection. Any money owed to the operator will be credited on the monthly ITNet statement.

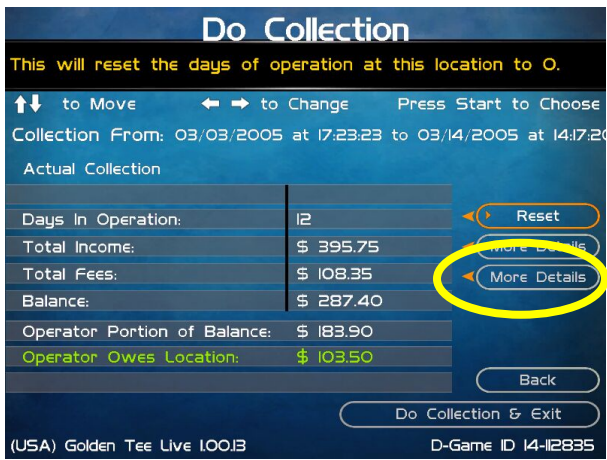

Once the location is paid, your collection is effectively complete. However, if you wish to view a more detailed breakdown of the various income and fee categories, use the trackball to highlight More Details and press the Start button.

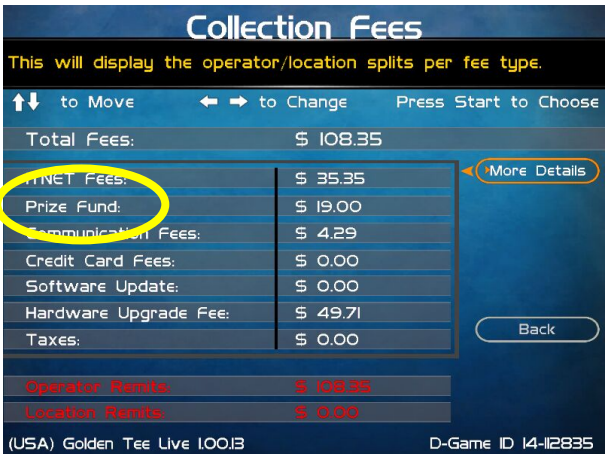

The Collection Fees menu displays the various fees associated with the current collection.

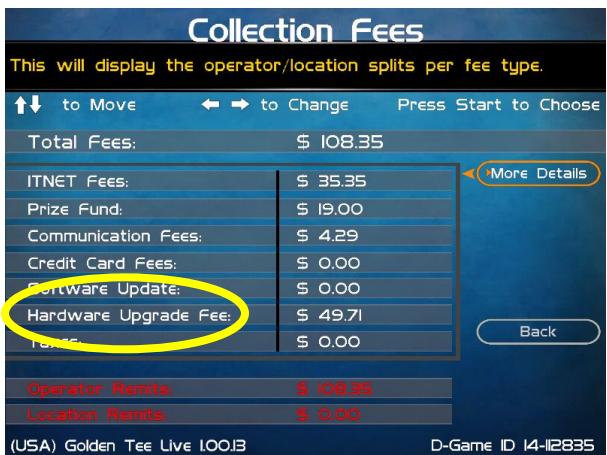

Note: The Hardware Upgrade Fee is included as a means for operators to have the location help pay for the cost of the game, and **IT does not collect or keep any portion of this fee**. This fee is completely adjustable and can be set to zero if desired.

Collection Fees

This will display the operator/location splits per fee type.

↑↓ to Move ← → to Change Press Start to Choose

Total Fees:	\$ 108.35	More Details
ITNET Fees:	\$ 35.35	
Prize Fund:	\$ 19.00	
Communication Fees:	\$ 4.29	
Credit Card Fees:	\$ 0.00	
Software Update:	\$ 0.00	
Hardware Upgrade Fee:	\$ 49.71	
Taxes:	\$ 0.00	
Back		
Operator Remits:	\$ 108.35	
Location Remits:	\$ 0.00	

(USA) Golden Tee Live 10013 D-Game ID 14-12835

If you wish to view the operator and location portions of these various fee categories, highlight More Details and press the Start button.

Collection Fee Details

This will take you back to the previous menu.

	Operator Portion	Location Portion	Total
ITNET Fees:	\$ 17.67	\$ 17.68	\$ 35.35
Prize Fund:	\$ 9.50	\$ 9.50	\$ 19.00
Communications Fee:	\$ 2.15	\$ 2.14	\$ 4.29
Credit Card Fees:	\$ 0.00	\$ 0.00	\$ 0.00
Software Update Fee:	\$ 0.00	\$ 0.00	\$ 0.00
Hardware Upgrade Fee:	\$ 24.86	\$ 24.85	\$ 49.71
Taxes:	\$ 0.00	\$ 0.00	\$ 0.00
TOTALS:	\$ 54.18	\$ 54.17	\$ 108.35
Operator Remits	\$ 108.35	To Incredible Technologies	
Operator Remits	\$ 0.00	To Tax Authorities	
Location Remits	\$ 0.00	To Tax Authorities	

Back

(USA) Golden Tee Live 10013 D-Game ID 14-12835

This screen further details the operator and location portions for the various fees, based on the adjustable split settings. See the GT LIVE manual for more information on how to set up your splits.

To exit this menu, highlight Back and press the Start button.

Do Collection

This will reset the days of operation at this location to 0.

↑↓ to Move ← → to Change Press Start to Choose

Collection From: 03/03/2005 at 17:23:23 to 03/14/2005 at 14:17:20

Actual Collection

Days In Operation:	12	Reset
Total Income:	\$ 395.75	More Details
Total Fees:	\$ 108.35	More Details
Balance:	\$ 287.40	
Operator Portion of Balance:	\$ 183.90	
Operator Owes Location:	\$ 103.50	

Do Collection & Exit

(USA) Golden Tee Live 10013 D-Game ID 14-12835

To complete your collection, get back to the Do Collection menu. Once there, use the trackball to highlight **Do Collection & Exit**, and press the Start button.

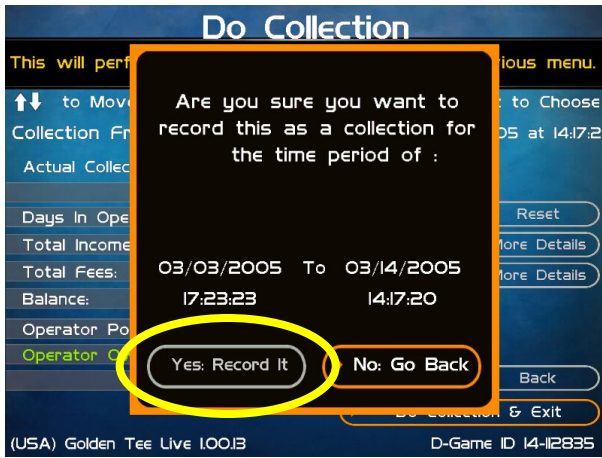

Check the dates in the window to make sure they match your time period. To complete the collection, highlight Yes: Record It and press the Start button.

This will reset all the income and fees to zero, so your next collection will be accurate for that time period.

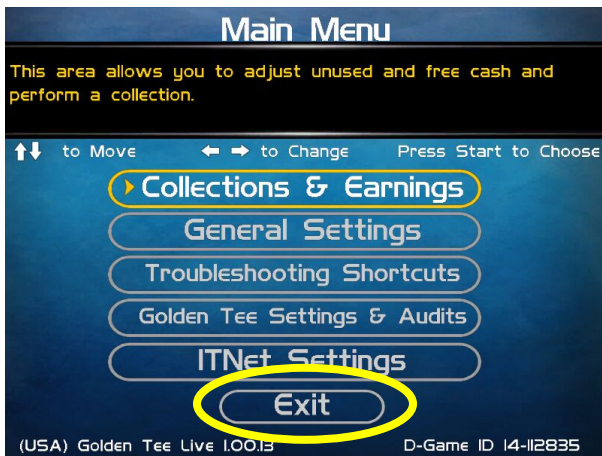

Continue to select Back on the various screens until you get to the Main Menu. Highlight Exit and press the Start button to exit System Setup mode and return to the game.

MENU NAVIGATION SHORTCUTS

Force a Call

- Push the red system setup button inside the coin door
- Select the **ITNet Settings** menu
- Select the **Connection Tests** menu
- Select **Force Call**
- Exit all the way out when complete

Change Collection Settings

- Push the red System Setup button inside the coin door
- Select **General Settings** menu
- Select **Operator Adjustables** menu
- Select **Collection Settings** menu
- Select the menu that you want changed

Disable Credit Cards

- Push the red system setup button inside the coin door
- Select **General Settings**
- Select **Operator Adjustables**
- Select **General Adjustments**
- Go to the **Accept Credit Card** line and change to a "Yes" or "No"

Add Operator Free Cash

- Push the red System Setup button inside the coin door
- Select **Collection and Earnings**
- Select **Add Free Cash**
- Move the trackball to select the desired dollar amount

APPENDIX G IT NET RULES AND REGISTRATI/ON FORMS



ITNet® Operating Rules

The following Rules shall govern the use of the ITNet system operated by Incredible Technologies, Inc., ("IT") for the benefit of owners of its products which can make use of it ("Operators.") Usage of the ITNet system constitutes agreement with, and agreement to comply with, these Rules. These Rules may be changed by IT at any time. Any change shall govern all usage of ITNet subsequent to such change being published on IT's web site or written notice of such change being provided to any given Operator, whichever comes first.

Forms: All Operators of TGAMES, as that term is used in the Operator Agreement (click here to review the Operator Agreement) must complete the following forms and keep them up-to-date with IT.

- The **ITNet Debit Account Form** requests basic bank account information, since a portion of the income generated by ITNet features is paid to Incredible Technologies, to be used for online features and administration. You can use your existing business account, or set up a separate account just for this purpose. Only one Debit form is required.
- The **ITNet Operator Agreement** outlines the basic commitments by both parties required to support the ITNet system.
- The **Game Registration Form** asks for the location that your machine is in. A separate Game Registration Form is required for each of your machines.
- An **IRS Form W-9** so that we may appropriately report all payments made to your company to the IRS as required by Federal law.

Timely Payment; Remedies: Operators of TGAMES shall timely pay all monies due IT in the normal course of business. Operators of TGAMES agree that IT may sweep their bank accounts as set forth in relevant payment agreements between IT and Operators for monies due IT, including monies due for products and services purchased by an Operator and not paid for by separate check or wire transfer. Operators of TGAMES further agree that IT shall have the right to limit the online access of, or disable, any TGAME owned by an Operator for which any payments, including but not limited to ITNet Fees or Upgrade Payments, are not paid timely. IT shall promptly re-enable any TGAME so disabled upon the payment of all monies owed to IT by Operator. Operators of TGAMES further agree that they will pay reasonable collection costs and fees, including simple interest of One Percent (1%) per calendar month or fraction of a calendar month on all payments more than fifteen (15) days late.

Operating Restrictions: Operators must obey the following rules and restrictions related to the operation of TGAMES:

1. Operators are required to assist IT in the enforcement of the Terms and Conditions of Play of the ITNet, which are posted on TGAMES and on the IT website. The Terms and Conditions of Play are herein incorporated by reference: Operators or employees of Operators who breach the Terms and Conditions of Play commit thereby a material breach of the Rules of the ITNet. Operators or employees of Operators who advise other persons to breach or disregard the Terms and Conditions of Play, or knowingly permit other persons to do so without notifying IT, likewise commit thereby a material breach of the Rules of the ITNet.
2. Operators must report non-compliance or cheating on ITNET Rules, either by other Operators or by players of TGAMES, should this become known to an Operator. If an Operator becomes aware of unusual play patterns on its TGAMES, it shall notify IT in a reasonable and timely manner of these unusual play patterns.

3. Operators shall only operate TGAMES at locations where OPERATOR has used its best, good-faith efforts to determine that the operation of TGAMES and related game play features are in compliance with all local, state, and other governmental body laws and regulations.
4. Operators shall make reasonable efforts to disable any user-adjustable feature which they know or should have known as not lawful to operate in the location where a TGAME is being operated.
5. Operators shall make reasonable efforts to properly license, certify, register, or otherwise comply with tracking, licensing and taxation requirements in the location where a TGAME is being operated. Operators shall indemnify and hold IT harmless for incorrect or inadequate licensing, registration, or taxation procedures which result in a claim against IT.
6. Operators shall only operate TGAMES in a traditional coin-operated environment. TGAMES shall be operated in a commercially reasonable fashion at all times. Failure to operate TGAMES in a commercially reasonable fashion, or to locate them in a traditional coin-operated environment, as determined solely by IT, shall be cause for appropriate action, up to and including loss of the ability to connect any given TGAME or TGAMES to the ITNet, at IT's sole discretion.
7. Operators agree that these Rules are subject to change at IT's sole discretion. Any change posted on IT's website and/or otherwise reasonably communicated to Operators shall be effective with regard to any particular TGAME upon the beginning of the next billing cycle for that TGAME.
8. As IT and Operators have the right to terminate the Operator Agreement at will and at their sole discretion, IT reserves the right, at its sole discretion, to impose sanctions for breach of the Operator's Agreement and/or the Rules of the ITNet upon Operators or individual TGAMES which are less onerous than a full termination of the Operator Agreement. Operators who do not agree to abide by the terms of sanctions imposed by IT must provide IT with written notice of same, which shall constitute written notice of termination of the Operator Agreement.

Game Maintenance: All Operators of TGAMES shall maintain such games in a reasonable and prudent manner, shall not materially alter them from the state in which they were sold by IT, and shall install and maintain all IT-supplied components as directed by IT in service manuals, service bulletins, and any other notification or instruction means. All Operators of TGAMES agree to indemnify and hold IT harmless for any claim by any Operator, employee or agent of an Operator, or any third party in which the Operator's installation or maintenance, or lack thereof, of a TGAME was a contributory factor in causing such claim. Operators shall also provide prompt and courteous technical support and service to locations where TGAMES have been placed in service.

ITNet Image/Text Placement: All Operators agree that IT has the right, at its sole discretion, to include images and/or text with TGAMES, or to push them to TGAMES through the ITNet or other suitable transmission or transfer means, which display during the play of TGAMES and/or when TGAMES are not in use. These images and/or text may include, but are not limited to, advertisements for IT's products and services, advertisements for the products and services of third parties, or images and/or text of an entertaining, educational, or whimsical nature.

Governing Law and Jurisdiction: The validity and construction of these Rules, and the Operator Agreement which governs and empowers them, and of the rights and obligations herein shall be determined and governed by the laws of the State of Illinois. The parties hereby submit to the Jurisdiction of any state or federal court in Cook County Illinois. Operators operating outside the borders of the United States of America, regardless of their citizenship or residency, explicitly agree to allow any assets they may have in the USA or any other foreign country to be attached, garnished, forfeited or otherwise reached by any legal act if, after due process of law, they are found to be liable to IT for damages by reason of breach of these Rules.

Severability: If any provision of these Rules shall be held by a court of competent jurisdiction to be illegal, invalid or unenforceable, the parties nevertheless agree that the court should endeavor to give effect to the parties' intentions as reflected in the provision, and the remaining provisions shall remain in full force and effect.

ITNet® Operating Rules Version 4/10



ITNET DEBIT ACCOUNT FORM

You **MUST** have this form on file at Incredible Technologies, Inc.
or your games will not be activated for online play.

After processing of the ITNet® forms, a personalized Operator Identification Card will be mailed to you.
The Operator Identification Card allows you to immediately register your games on-site.

Billing Information for Automatic Debit Payments

Authorization Agreement for Pre-authorized Payments For participation in ITNet®

I (we) authorize Incredible Technologies, Inc., hereafter called COMPANY, to initiate debit entries to my (our) bank account indicated below. I (we) authorize the financial institution named below, hereafter called INSTITUTION, to credit the amount of such entries to my (our) account to correct any errors, and the Institution to deposit any such corrections to my (our) account. I have attached an unsigned and voided check for the account I wish to be debited from time to time and in varying amounts.

Please Print Clearly and Legibly to Insure Accuracy.

_____		<input type="checkbox"/> Checking Account	<input type="checkbox"/> Savings Account
Company Name		_____	
_____		Bank Account Number	
Address		_____	
_____	_____	Bank Routing Number (VERY IMPORTANT)	
City, State, Zip	County	_____	
_____		Bank Name	
Company Contact		_____	
() _____	() _____	_____	
Phone Number	Fax Number	Bank Phone Number	

To assist in verifying data, please attach an unsigned voided blank check from your account.

The authority is to remain in full force and effect until I (we) revoke the agreement in writing as hereafter provided. Any revocation is effective only after COMPANY has received written notice from me (us) to terminate this agreement in such time and manner to afford a reasonable opportunity to act upon the notice. I (we) have the right to stop payment of a debit entry by notification to the Institution in such time and manner to afford a reasonable opportunity to act prior to charging the account. A copy of this authorization will be provided at your request.

Email Addresses

Incredible Technologies® can alert you to a variety of information through email.
Please fill in the name and email address of the parties responsible for the following areas:

Main _____	_____
Main Contact Name	Main Contact Email Address
Billing _____	_____
Billing Contact Name	Billing Contact Email Address
Technical _____	_____
Technical Contact Name	Technical Contact Email Address
Promotions _____	_____
Promotions Contact Name	Promotions Contact Email Address

Authorized Signature _____ **Date** _____

Signature MUST accompany this form.



Fill out this form completely and mail or fax to:
Incredible Technologies, Inc.
200 Corporate Woods Parkway, Vernon Hills, IL 60061
(847) 870-7027 Phone (847) 454-9155 ITNet Registration Fax
Allow up to 10 Business Days for Processing.



ITNET GAME REGISTRATION FORM

USE THIS FORM ONLY IF YOU CANNOT REGISTER YOUR GAME ON-SITE.

For faster service, Use Your ITNet® Operator Identification Card and Register Your Game Right at the Location!

Company Name: _____ Contact: _____

Address: _____

Phone: _____ Date: _____

Fax: _____ Email: _____

ITNet® Operator ID Number: _____

Debit Account On File: Yes No If No, include ITNet® Debit Account Form.

Game Type: Golden Tee LIVE Silver Strike LIVE PowerPutt LIVE

Game ID Number/CID: _____

Location Name: _____

Location Address: _____

City/State: _____ Zip Code: _____
Be sure the Zip Code is accurate.

Location Phone Number: (_____) _____

Please Select One of the Following:

Please **REGISTER** this Game.

Please **UNREGISTER** This Game.

This Game is in a **NEW LOCATI/ON**.
Old Location Name: _____

Authorized Signature _____ Date _____

Signature **MUST** accompany this form.



Fill out this form completely and mail or fax to:
Incredible Technologies, Inc.
 200 Corporate Woods Parkway, Vernon Hills, IL 60061
 (847) 870-7027 Phone (847) 454-9155 ITNet Registration Fax
 Allow up to 10 Business Days for Processing.



ITNET™ OPERATOR AGREEMENT

IMPORTANT!!

THIS DOCUMENT MUST BE SIGNED AND ON FILE WITH INCREDIBLE TECHNOLOGIES FOR YOUR GOLDEN TEE LIVE AND SILVER STRIKE LIVE MACHINES TO RECEIVE ONLINE FEATURES OR TO RECEIVE TECHNICAL SUPPORT FOR THEM.

This AGREEMENT is made and entered into this _____ day of _____, 20___, by and between Incredible Technologies, Inc. ("IT"), an Illinois corporation, whose address is 200 Corporate Woods Parkway, Vernon Hills, IL 60061, and, _____ ("OPERATOR"), whose address is:

WHEREAS, IT is skilled in the design of hardware and software relating to coin-operated video games, and; WHEREAS, OPERATOR is skilled in the operation and management of coin-operated video games and represents that it is in the business of operating and managing the same.

NOW THEREFORE, for and in consideration of the mutual promises herein and other valuable consideration, the parties agree as follows:

1. APPLICATION.

This Agreement shall apply to the operation of all games ("TGAMES") that are capable of connecting to IT's Incredible Technologies Network ("ITNET") that Operator elects to register with the ITNET for the purpose of obtaining additional services and/or enabling additional game play features. It shall also apply to the operation of all IT games owned and operated by OPERATOR which are not online ("UGAMES") as set forth below.

2. IT OBLIGATIONS.

IT agrees to do the following:

- A. Administer the ITNET and offer contests on a regular and periodic basis throughout the year, and allow OPERATOR'S TGAMES to be included in such contests provided that OPERATOR has complied with all ITNET rules and regulations, which are subject to change at IT's sole discretion without notice, and this Agreement;
- B. Be responsible for payment and distribution of all IT sponsored contest prizes;
- C. Provide technical support to technical representatives of OPERATOR in the installation and maintenance of TGAMES, in their connection to the ITNET, and in the installation and maintenance of UGAMES as set forth in sales agreements and accompanying manuals and warranties;
- D. Fax, mail, email or otherwise make available billing statements to OPERATOR at least 4 business days prior to the date of automatic debiting of amounts owed to IT for ITNET related fees;
- E. Provide usual and customary accounting and related services for ITNET fees, prizes, IRS 1099 reporting, and the like;
- F. Warrant TGAMES and UGAMES for 90 day replacement for defects in materials and workmanship;
- G. Pay all money, if any, owed to OPERATOR timely when due, as determined by IT in its sole discretion;
- H. Use its best reasonable efforts to positively promote the ITNET program.

3. OPERATOR OBLIGATIONS.

OPERATOR agrees to do the following:

- A. Operate all TGAMES ITNET and UGAMES according to the terms of this Agreement, including adherence to the terms and conditions of the ITNET for games connected to the ITNET;
- B. Fill out and submit Game Initialization Forms, Game Registration Forms, Debit Account Forms, and such other forms as IT may require from time to time;
- C. Comply with the rules and regulations of the ITNET, which are subject to change at IT's sole discretion without notice, and report non-compliance or cheating on ITNET rules should this become known to OPERATOR;
- D. Provide prompt and courteous technical support and service to locations where the TGAMES and UGAMES have been placed in service;
- E. Pay all money owed to IT, including but not limited to any and all ITNET fees incurred on games registered to Operator's account, by depositing such amounts in the account that OPERATOR sets up under the Debit Account Form prior to the date that the account will be automatically debited;
- F. Only operate TGAMES and/or UGAMES at locations where OPERATOR has used its best, good-faith efforts to determine that the operation of TGAMES and/or UGAMES and related game play features are in compliance with all local, state, and other governmental body laws and regulations;

G. Only operate TGAMES and/or UGAMES in a traditional coin-operated environment as determined solely by IT, unless otherwise approved by IT;
H. Hold IT harmless for any losses due to theft or machine setting tampering;
I. Use its best reasonable efforts to positively promote the ITNET program; and,
J. Re-register TGAMES when any relevant information changes, including but not limited to moving the TGAME to a new location or selling the TGAME to a new Operator. Pay all ITNet Fees incurred by a TGAME unless and until it is either registered to the new Operator or unregistered by the current Operator.

4. TIMELY PAYMENT; REMEDIES

OPERATOR agrees to timely pay all monies due IT in the normal course of business. OPERATOR agrees that IT may sweep OPERATOR'S bank accounts as set forth in relevant payment agreements between IT and OPERATOR for monies due IT, including monies due for products and services purchased by OPERATOR and not paid for by separate check or wire transfer. OPERATOR further agrees that IT shall have the right to limit the online access of, or disable, any TGAME or UGAME owned by OPERATOR for which any payments, including but not limited to ITNet Fees or Upgrade Payments, are not paid timely. IT agrees to promptly re-enable any TGAME or UGAME so disabled upon the payment of all monies owed to IT by OPERATOR. Operators of TGAMES further agree that they will pay reasonable collection costs and fees, including simple interest of One Percent (1%) per calendar month or fraction of a calendar month on all payments more than fifteen (15) days late.

5. TAXES.

OPERATOR agrees to pay all taxes, fees, and assessments of any kind which may be assessed by any governmental body on the fees generated by the TGAMES and UGAMES, including, but not limited to any gross receipts taxes. OPERATOR is not responsible for any income tax or related assessments that are directly attributable to the business of IT.

6. ASSIGNMENT.

Neither party to this Agreement may sell, assign, transfer, pledge, or encumber, with or without consideration, all or any part of their interest in this Agreement without first obtaining the written consent of the other party.

7. EXPIRATION AND TERMINATION.

This Agreement shall continue in force for a period of one year from the date hereof, and shall automatically renew for successive one-year periods upon the anniversary date, and annually thereafter, unless sooner terminated in writing. Notwithstanding the forgoing, either party may terminate this agreement immediately upon notice to the other party.

8. EFFECT OF TERMINATION.

No termination shall affect any right, liability, or obligation, which accrues prior to such termination. Additionally, termination shall not affect either party's obligations to the other which by the nature thereof are intended to survive any such termination, including, but not limited to, the obligations of maintaining confidentiality as well as the obligations for payment of any outstanding monies that may be owed by one party to another and related remedies.

9. CONFIDENTIALITY.

Each party agrees that the trade secrets, technological information, marketing plans, game play data, location and game revenue data, and any other confidential business information disclosed in the course of performance under this Agreement, including the terms of this Agreement, shall be held in strict confidence and not disclosed to anyone without the written consent of the other party. Notwithstanding the forgoing, OPERATOR may share such financial information relating to TGAMES and/or UGAMES as OPERATOR deems appropriate with the locations in which the TGAMES and/or UGAMES are operated, and IT may list or otherwise publish such non-financial information regarding OPERATOR and the locations at which the TGAMES and/or UGAMES are operated on its website(s). Furthermore, IT may disclose such information as is reasonably necessary to collect unpaid accounts to debt collection agencies and/or its legal representatives. This provision shall survive the termination or expiration of this agreement for a period of two years from the date thereof.

10. ITNet IMAGE/TEXT PLACEMENT.

All Operators agree that IT has the right, at its sole discretion, to include images and/or text with TGAMES, or to push them to TGAMES through the ITNet or other suitable transmission or transfer means, which display during the play of TGAMES and/or when TGAMES are not in use. These images and/or text may include, but are not limited to, advertisements for IT's products and services, advertisements for the products and services of third parties, or images and/or text of an entertaining, educational, or whimsical nature.

11. GOVERNING LAW AND JURISDICTION.

The validity and construction of this Agreement and of the rights and obligations herein shall be determined and governed by the laws of the State of Illinois. The parties hereby submit to the Jurisdiction of any state or federal court in Cook County Illinois. OPERATORS operating outside the borders of the United States of America, regardless of their citizenship or residency, explicitly agree to allow any assets they may have in the USA or any other foreign country to be attached, garnished, forfeited or otherwise reached by any legal act if, after due process of law, they are found to be liable to IT for damages by reason of breach of this Agreement.

12. SEVERABILITY.

If any provision of this Agreement shall be held by a court of competent jurisdiction to be illegal, invalid or unenforceable, the parties nevertheless agree that the court should endeavor to give effect to the parties' intentions as reflected in the provision, and the remaining provisions shall remain in full force and effect.

13. HEADINGS.

The headings in this Agreement are inserted for convenience and reference only, and are not intended to be part of or to affect the meaning or interpretation of this Agreement.

14. ENTIRE AGREEMENT, MODIFICATION AND MERGER.

This Agreement, including the Exhibits attached hereto, if any, states the entire Agreement between the parties with respect to the subject matter hereof, and supersedes and cancels all previous agreements, negotiations, commitments and representations regarding the subject matter of hereof which may have previously been made between the parties, whether orally or in writing. This Agreement may not be modified or altered except by written instrument duly executed by both parties.

15. ADDITIONAL DOCUMENTS.

The parties shall execute any and all documents, agreements, contracts, or other writings, which may be necessary or appropriate to carry out the terms, spirit and intent of this Agreement.

16. COUNTERPARTS.

This Agreement may be executed in any number of counterparts, each of which will be deemed an original, but all of which together shall constitute one and the same instrument.

17. INDEPENDENT CONTRACTORS.

Each of the parties to this Agreement shall be deemed to have the status of independent contractors, and nothing contained herein shall be deemed or construed as creating a joint venture, partnership, agency, or employer/employee relationship between the parties.

In Witness Whereof, the parties hereto have duly executed this Agreement on the day and year first written above.

INCREDIBLE TECHNOLOGIES, INC.

OPERATOR

By: _____

By: _____

Its: _____

Its: _____

(Printed name and title)

(Printed name and title)

IMPORTANT!!

THIS DOCUMENT MUST BE SIGNED AND ON FILE WITH INCREDIBLE TECHNOLOGIES FOR YOUR GOLDEN TEE LIVE MACHINES TO RECEIVE ONLINE FEATURES. YOU MUST ALSO RETURN ALL NECESSARY IRS FORMS BEFORE YOUR ACCOUNT CAN BE ENABLED AND ONLINE FEATURES ACCESSED.

Fill out this form completely and mail or fax to:

**Incredible Technologies, Inc.
200 Corporate Woods Parkway
Vernon Hills, IL 60061
(847) 870-7027 Phone (847) 454-9155 ITNet Registration Fax**

Allow up to 10 Business Days for Processing.

Request for Taxpayer Identification Number and Certification

**Give Form to the
 requester. Do not
 send to the IRS.**

Print or type See Specific Instructions on page 2.	Name (as shown on your income tax return)	
	Business name/disregarded entity name, if different from above	
	Check appropriate box for federal tax classification (required): <input type="checkbox"/> Individual/sole proprietor <input type="checkbox"/> C Corporation <input type="checkbox"/> S Corporation <input type="checkbox"/> Partnership <input type="checkbox"/> Trust/estate	
	<input type="checkbox"/> Limited liability company. Enter the tax classification (C=C corporation, S=S corporation, P=partnership) ▶	
	<input type="checkbox"/> Other (see instructions) ▶	
Address (number, street, and apt. or suite no.)		Requester's name and address (optional)
City, state, and ZIP code		
List account number(s) here (optional)		

Part I Taxpayer Identification Number (TIN)

Enter your TIN in the appropriate box. The TIN provided must match the name given on the "Name" line to avoid backup withholding. For individuals, this is your social security number (SSN). However, for a resident alien, sole proprietor, or disregarded entity, see the Part I instructions on page 3. For other entities, it is your employer identification number (EIN). If you do not have a number, see *How to get a TIN* on page 3.

Social security number									

Note. If the account is in more than one name, see the chart on page 4 for guidelines on whose number to enter.

Employer identification number									

Part II Certification

Under penalties of perjury, I certify that:

1. The number shown on this form is my correct taxpayer identification number (or I am waiting for a number to be issued to me), and
2. I am not subject to backup withholding because: (a) I am exempt from backup withholding, or (b) I have not been notified by the Internal Revenue Service (IRS) that I am subject to backup withholding as a result of a failure to report all interest or dividends, or (c) the IRS has notified me that I am no longer subject to backup withholding, and
3. I am a U.S. citizen or other U.S. person (defined below).

Certification instructions. You must cross out item 2 above if you have been notified by the IRS that you are currently subject to backup withholding because you have failed to report all interest and dividends on your tax return. For real estate transactions, item 2 does not apply. For mortgage interest paid, acquisition or abandonment of secured property, cancellation of debt, contributions to an individual retirement arrangement (IRA), and generally, payments other than interest and dividends, you are not required to sign the certification, but you must provide your correct TIN. See the instructions on page 4.

Sign Here	Signature of U.S. person ▶	Date ▶
------------------	----------------------------	--------

General Instructions

Section references are to the Internal Revenue Code unless otherwise noted.

Purpose of Form

A person who is required to file an information return with the IRS must obtain your correct taxpayer identification number (TIN) to report, for example, income paid to you, real estate transactions, mortgage interest you paid, acquisition or abandonment of secured property, cancellation of debt, or contributions you made to an IRA.

Use Form W-9 only if you are a U.S. person (including a resident alien), to provide your correct TIN to the person requesting it (the requester) and, when applicable, to:

1. Certify that the TIN you are giving is correct (or you are waiting for a number to be issued),
2. Certify that you are not subject to backup withholding, or
3. Claim exemption from backup withholding if you are a U.S. exempt payee. If applicable, you are also certifying that as a U.S. person, your allocable share of any partnership income from a U.S. trade or business is not subject to the withholding tax on foreign partners' share of effectively connected income.

Note. If a requester gives you a form other than Form W-9 to request your TIN, you must use the requester's form if it is substantially similar to this Form W-9.

Definition of a U.S. person. For federal tax purposes, you are considered a U.S. person if you are:

- An individual who is a U.S. citizen or U.S. resident alien,
- A partnership, corporation, company, or association created or organized in the United States or under the laws of the United States,
- An estate (other than a foreign estate), or
- A domestic trust (as defined in Regulations section 301.7701-7).

Special rules for partnerships. Partnerships that conduct a trade or business in the United States are generally required to pay a withholding tax on any foreign partners' share of income from such business. Further, in certain cases where a Form W-9 has not been received, a partnership is required to presume that a partner is a foreign person, and pay the withholding tax. Therefore, if you are a U.S. person that is a partner in a partnership conducting a trade or business in the United States, provide Form W-9 to the partnership to establish your U.S. status and avoid withholding on your share of partnership income.

The person who gives Form W-9 to the partnership for purposes of establishing its U.S. status and avoiding withholding on its allocable share of net income from the partnership conducting a trade or business in the United States is in the following cases:

- The U.S. owner of a disregarded entity and not the entity,
- The U.S. grantor or other owner of a grantor trust and not the trust, and
- The U.S. trust (other than a grantor trust) and not the beneficiaries of the trust.

Foreign person. If you are a foreign person, do not use Form W-9. Instead, use the appropriate Form W-8 (see Publication 515, Withholding of Tax on Nonresident Aliens and Foreign Entities).

Nonresident alien who becomes a resident alien. Generally, only a nonresident alien individual may use the terms of a tax treaty to reduce or eliminate U.S. tax on certain types of income. However, most tax treaties contain a provision known as a “saving clause.” Exceptions specified in the saving clause may permit an exemption from tax to continue for certain types of income even after the payee has otherwise become a U.S. resident alien for tax purposes.

If you are a U.S. resident alien who is relying on an exception contained in the saving clause of a tax treaty to claim an exemption from U.S. tax on certain types of income, you must attach a statement to Form W-9 that specifies the following five items:

1. The treaty country. Generally, this must be the same treaty under which you claimed exemption from tax as a nonresident alien.
2. The treaty article addressing the income.
3. The article number (or location) in the tax treaty that contains the saving clause and its exceptions.
4. The type and amount of income that qualifies for the exemption from tax.
5. Sufficient facts to justify the exemption from tax under the terms of the treaty article.

Example. Article 20 of the U.S.-China income tax treaty allows an exemption from tax for scholarship income received by a Chinese student temporarily present in the United States. Under U.S. law, this student will become a resident alien for tax purposes if his or her stay in the United States exceeds 5 calendar years. However, paragraph 2 of the first Protocol to the U.S.-China treaty (dated April 30, 1984) allows the provisions of Article 20 to continue to apply even after the Chinese student becomes a resident alien of the United States. A Chinese student who qualifies for this exception (under paragraph 2 of the first protocol) and is relying on this exception to claim an exemption from tax on his or her scholarship or fellowship income would attach to Form W-9 a statement that includes the information described above to support that exemption.

If you are a nonresident alien or a foreign entity not subject to backup withholding, give the requester the appropriate completed Form W-8.

What is backup withholding? Persons making certain payments to you must under certain conditions withhold and pay to the IRS a percentage of such payments. This is called “backup withholding.” Payments that may be subject to backup withholding include interest, tax-exempt interest, dividends, broker and barter exchange transactions, rents, royalties, nonemployee pay, and certain payments from fishing boat operators. Real estate transactions are not subject to backup withholding.

You will not be subject to backup withholding on payments you receive if you give the requester your correct TIN, make the proper certifications, and report all your taxable interest and dividends on your tax return.

Payments you receive will be subject to backup withholding if:

1. You do not furnish your TIN to the requester,
2. You do not certify your TIN when required (see the Part II instructions on page 3 for details),
3. The IRS tells the requester that you furnished an incorrect TIN,
4. The IRS tells you that you are subject to backup withholding because you did not report all your interest and dividends on your tax return (for reportable interest and dividends only), or
5. You do not certify to the requester that you are not subject to backup withholding under 4 above (for reportable interest and dividend accounts opened after 1983 only).

Certain payees and payments are exempt from backup withholding. See the instructions below and the separate Instructions for the Requester of Form W-9.

Also see *Special rules for partnerships* on page 1.

Updating Your Information

You must provide updated information to any person to whom you claimed to be an exempt payee if you are no longer an exempt payee and anticipate receiving reportable payments in the future from this person. For example, you may need to provide updated information if you are a C corporation that elects to be an S corporation, or if you no longer are tax exempt. In addition, you must furnish a new Form W-9 if the name or TIN changes for the account, for example, if the grantor of a grantor trust dies.

Penalties

Failure to furnish TIN. If you fail to furnish your correct TIN to a requester, you are subject to a penalty of \$50 for each such failure unless your failure is due to reasonable cause and not to willful neglect.

Civil penalty for false information with respect to withholding. If you make a false statement with no reasonable basis that results in no backup withholding, you are subject to a \$500 penalty.

Criminal penalty for falsifying information. Willfully falsifying certifications or affirmations may subject you to criminal penalties including fines and/or imprisonment.

Misuse of TINs. If the requester discloses or uses TINs in violation of federal law, the requester may be subject to civil and criminal penalties.

Specific Instructions

Name

If you are an individual, you must generally enter the name shown on your income tax return. However, if you have changed your last name, for instance, due to marriage without informing the Social Security Administration of the name change, enter your first name, the last name shown on your social security card, and your new last name.

If the account is in joint names, list first, and then circle, the name of the person or entity whose number you entered in Part I of the form.

Sole proprietor. Enter your individual name as shown on your income tax return on the “Name” line. You may enter your business, trade, or “doing business as (DBA)” name on the “Business name/disregarded entity name” line.

Partnership, C Corporation, or S Corporation. Enter the entity's name on the “Name” line and any business, trade, or “doing business as (DBA) name” on the “Business name/disregarded entity name” line.

Disregarded entity. Enter the owner's name on the “Name” line. The name of the entity entered on the “Name” line should never be a disregarded entity. The name on the “Name” line must be the name shown on the income tax return on which the income will be reported. For example, if a foreign LLC that is treated as a disregarded entity for U.S. federal tax purposes has a domestic owner, the domestic owner's name is required to be provided on the “Name” line. If the direct owner of the entity is also a disregarded entity, enter the first owner that is not disregarded for federal tax purposes. Enter the disregarded entity's name on the “Business name/disregarded entity name” line. If the owner of the disregarded entity is a foreign person, you must complete an appropriate Form W-8.

Note. Check the appropriate box for the federal tax classification of the person whose name is entered on the “Name” line (Individual/sole proprietor, Partnership, C Corporation, S Corporation, Trust/estate).

Limited Liability Company (LLC). If the person identified on the “Name” line is an LLC, check the “Limited liability company” box only and enter the appropriate code for the tax classification in the space provided. If you are an LLC that is treated as a partnership for federal tax purposes, enter “P” for partnership. If you are an LLC that has filed a Form 8832 or a Form 2553 to be taxed as a corporation, enter “C” for C corporation or “S” for S corporation. If you are an LLC that is disregarded as an entity separate from its owner under Regulation section 301.7701-3 (except for employment and excise tax), do not check the LLC box unless the owner of the LLC (required to be identified on the “Name” line) is another LLC that is not disregarded for federal tax purposes. If the LLC is disregarded as an entity separate from its owner, enter the appropriate tax classification of the owner identified on the “Name” line.

Other entities. Enter your business name as shown on required federal tax documents on the "Name" line. This name should match the name shown on the charter or other legal document creating the entity. You may enter any business, trade, or DBA name on the "Business name/disregarded entity name" line.

Exempt Payee

If you are exempt from backup withholding, enter your name as described above and check the appropriate box for your status, then check the "Exempt payee" box in the line following the "Business name/disregarded entity name," sign and date the form.

Generally, individuals (including sole proprietors) are not exempt from backup withholding. Corporations are exempt from backup withholding for certain payments, such as interest and dividends.

Note. If you are exempt from backup withholding, you should still complete this form to avoid possible erroneous backup withholding.

The following payees are exempt from backup withholding:

1. An organization exempt from tax under section 501(a), any IRA, or a custodial account under section 403(b)(7) if the account satisfies the requirements of section 401(f)(2),
 2. The United States or any of its agencies or instrumentalities,
 3. A state, the District of Columbia, a possession of the United States, or any of their political subdivisions or instrumentalities,
 4. A foreign government or any of its political subdivisions, agencies, or instrumentalities, or
 5. An international organization or any of its agencies or instrumentalities.
- Other payees that may be exempt from backup withholding include:
6. A corporation,
 7. A foreign central bank of issue,
 8. A dealer in securities or commodities required to register in the United States, the District of Columbia, or a possession of the United States,
 9. A futures commission merchant registered with the Commodity Futures Trading Commission,
 10. A real estate investment trust,
 11. An entity registered at all times during the tax year under the Investment Company Act of 1940,
 12. A common trust fund operated by a bank under section 584(a),
 13. A financial institution,
 14. A middleman known in the investment community as a nominee or custodian, or
 15. A trust exempt from tax under section 664 or described in section 4947.

The following chart shows types of payments that may be exempt from backup withholding. The chart applies to the exempt payees listed above, 1 through 15.

IF the payment is for . . .	THEN the payment is exempt for . . .
Interest and dividend payments	All exempt payees except for 9
Broker transactions	Exempt payees 1 through 5 and 7 through 13. Also, C corporations.
Barter exchange transactions and patronage dividends	Exempt payees 1 through 5
Payments over \$600 required to be reported and direct sales over \$5,000 ¹	Generally, exempt payees 1 through 7 ²

¹ See Form 1099-MISC, Miscellaneous Income, and its instructions.

² However, the following payments made to a corporation and reportable on Form 1099-MISC are not exempt from backup withholding: medical and health care payments, attorneys' fees, gross proceeds paid to an attorney, and payments for services paid by a federal executive agency.

Part I. Taxpayer Identification Number (TIN)

Enter your TIN in the appropriate box. If you are a resident alien and you do not have and are not eligible to get an SSN, your TIN is your IRS individual taxpayer identification number (ITIN). Enter it in the social security number box. If you do not have an ITIN, see *How to get a TIN* below.

If you are a sole proprietor and you have an EIN, you may enter either your SSN or EIN. However, the IRS prefers that you use your SSN.

If you are a single-member LLC that is disregarded as an entity separate from its owner (see *Limited Liability Company (LLC)* on page 2), enter the owner's SSN (or EIN, if the owner has one). Do not enter the disregarded entity's EIN. If the LLC is classified as a corporation or partnership, enter the entity's EIN.

Note. See the chart on page 4 for further clarification of name and TIN combinations.

How to get a TIN. If you do not have a TIN, apply for one immediately. To apply for an SSN, get Form SS-5, Application for a Social Security Card, from your local Social Security Administration office or get this form online at www.ssa.gov. You may also get this form by calling 1-800-772-1213. Use Form W-7, Application for IRS Individual Taxpayer Identification Number, to apply for an ITIN, or Form SS-4, Application for Employer Identification Number, to apply for an EIN. You can apply for an EIN online by accessing the IRS website at www.irs.gov/businesses and clicking on Employer Identification Number (EIN) under Starting a Business. You can get Forms W-7 and SS-4 from the IRS by visiting IRS.gov or by calling 1-800-TAX-FORM (1-800-829-3676).

If you are asked to complete Form W-9 but do not have a TIN, write "Applied For" in the space for the TIN, sign and date the form, and give it to the requester. For interest and dividend payments, and certain payments made with respect to readily tradable instruments, generally you will have 60 days to get a TIN and give it to the requester before you are subject to backup withholding on payments. The 60-day rule does not apply to other types of payments. You will be subject to backup withholding on all such payments until you provide your TIN to the requester.

Note. Entering "Applied For" means that you have already applied for a TIN or that you intend to apply for one soon.

Caution: A disregarded domestic entity that has a foreign owner must use the appropriate Form W-8.

Part II. Certification

To establish to the withholding agent that you are a U.S. person, or resident alien, sign Form W-9. You may be requested to sign by the withholding agent even if item 1, below, and items 4 and 5 on page 4 indicate otherwise.

For a joint account, only the person whose TIN is shown in Part I should sign (when required). In the case of a disregarded entity, the person identified on the "Name" line must sign. Exempt payees, see *Exempt Payee* on page 3.

Signature requirements. Complete the certification as indicated in items 1 through 3, below, and items 4 and 5 on page 4.

1. Interest, dividend, and barter exchange accounts opened before 1984 and broker accounts considered active during 1983. You must give your correct TIN, but you do not have to sign the certification.

2. Interest, dividend, broker, and barter exchange accounts opened after 1983 and broker accounts considered inactive during 1983. You must sign the certification or backup withholding will apply. If you are subject to backup withholding and you are merely providing your correct TIN to the requester, you must cross out item 2 in the certification before signing the form.

3. Real estate transactions. You must sign the certification. You may cross out item 2 of the certification.

4. Other payments. You must give your correct TIN, but you do not have to sign the certification unless you have been notified that you have previously given an incorrect TIN. "Other payments" include payments made in the course of the requester's trade or business for rents, royalties, goods (other than bills for merchandise), medical and health care services (including payments to corporations), payments to a nonemployee for services, payments to certain fishing boat crew members and fishermen, and gross proceeds paid to attorneys (including payments to corporations).

5. Mortgage interest paid by you, acquisition or abandonment of secured property, cancellation of debt, qualified tuition program payments (under section 529), IRA, Coverdell ESA, Archer MSA or HSA contributions or distributions, and pension distributions. You must give your correct TIN, but you do not have to sign the certification.

What Name and Number To Give the Requester

For this type of account:	Give name and SSN of:
1. Individual	The individual
2. Two or more individuals (joint account)	The actual owner of the account or, if combined funds, the first individual on the account ¹
3. Custodian account of a minor (Uniform Gift to Minors Act)	The minor ²
4. a. The usual revocable savings trust (grantor is also trustee) b. So-called trust account that is not a legal or valid trust under state law	The grantor-trustee ¹ The actual owner ¹
5. Sole proprietorship or disregarded entity owned by an individual	The owner ³
6. Grantor trust filing under Optional Form 1099 Filing Method 1 (see Regulation section 1.671-4(b)(2)(i)(A))	The grantor*
For this type of account:	Give name and EIN of:
7. Disregarded entity not owned by an individual	The owner
8. A valid trust, estate, or pension trust	Legal entity ⁴
9. Corporation or LLC electing corporate status on Form 8832 or Form 2553	The corporation
10. Association, club, religious, charitable, educational, or other tax-exempt organization	The organization
11. Partnership or multi-member LLC	The partnership
12. A broker or registered nominee	The broker or nominee
13. Account with the Department of Agriculture in the name of a public entity (such as a state or local government, school district, or prison) that receives agricultural program payments	The public entity
14. Grantor trust filing under the Form 1041 Filing Method or the Optional Form 1099 Filing Method 2 (see Regulation section 1.671-4(b)(2)(i)(B))	The trust

¹ List first and circle the name of the person whose number you furnish. If only one person on a joint account has an SSN, that person's number must be furnished.

² Circle the minor's name and furnish the minor's SSN.

³ You must show your individual name and you may also enter your business or "DBA" name on the "Business name/disregarded entity" name line. You may use either your SSN or EIN (if you have one), but the IRS encourages you to use your SSN.

⁴ List first and circle the name of the trust, estate, or pension trust. (Do not furnish the TIN of the personal representative or trustee unless the legal entity itself is not designated in the account title.) Also see *Special rules for partnerships* on page 1.

*Note. Grantor also must provide a Form W-9 to trustee of trust.

Note. If no name is circled when more than one name is listed, the number will be considered to be that of the first name listed.

Secure Your Tax Records from Identity Theft

Identity theft occurs when someone uses your personal information such as your name, social security number (SSN), or other identifying information, without your permission, to commit fraud or other crimes. An identity thief may use your SSN to get a job or may file a tax return using your SSN to receive a refund.

To reduce your risk:

- Protect your SSN,
- Ensure your employer is protecting your SSN, and
- Be careful when choosing a tax preparer.

If your tax records are affected by identity theft and you receive a notice from the IRS, respond right away to the name and phone number printed on the IRS notice or letter.

If your tax records are not currently affected by identity theft but you think you are at risk due to a lost or stolen purse or wallet, questionable credit card activity or credit report, contact the IRS Identity Theft Hotline at 1-800-908-4490 or submit Form 14039.

For more information, see Publication 4535, Identity Theft Prevention and Victim Assistance.

Victims of identity theft who are experiencing economic harm or a system problem, or are seeking help in resolving tax problems that have not been resolved through normal channels, may be eligible for Taxpayer Advocate Service (TAS) assistance. You can reach TAS by calling the TAS toll-free case intake line at 1-877-777-4778 or TTY/TDD 1-800-829-4059.

Protect yourself from suspicious emails or phishing schemes.

Phishing is the creation and use of email and websites designed to mimic legitimate business emails and websites. The most common act is sending an email to a user falsely claiming to be an established legitimate enterprise in an attempt to scam the user into surrendering private information that will be used for identity theft.

The IRS does not initiate contacts with taxpayers via emails. Also, the IRS does not request personal detailed information through email or ask taxpayers for the PIN numbers, passwords, or similar secret access information for their credit card, bank, or other financial accounts.

If you receive an unsolicited email claiming to be from the IRS, forward this message to phishing@irs.gov. You may also report misuse of the IRS name, logo, or other IRS property to the Treasury Inspector General for Tax Administration at 1-800-366-4484. You can forward suspicious emails to the Federal Trade Commission at: spam@uce.gov or contact them at www.ftc.gov/idtheft or 1-877-IDTHEFT (1-877-438-4338).

Visit IRS.gov to learn more about identity theft and how to reduce your risk.

Privacy Act Notice

Section 6109 of the Internal Revenue Code requires you to provide your correct TIN to persons (including federal agencies) who are required to file information returns with the IRS to report interest, dividends, or certain other income paid to you; mortgage interest you paid; the acquisition or abandonment of secured property; the cancellation of debt; or contributions you made to an IRA, Archer MSA, or HSA. The person collecting this form uses the information on the form to file information returns with the IRS, reporting the above information. Routine uses of this information include giving it to the Department of Justice for civil and criminal litigation and to cities, states, the District of Columbia, and U.S. possessions for use in administering their laws. The information also may be disclosed to other countries under a treaty, to federal and state agencies to enforce civil and criminal laws, or to federal law enforcement and intelligence agencies to combat terrorism. You must provide your TIN whether or not you are required to file a tax return. Under section 3406, payers must generally withhold a percentage of taxable interest, dividend, and certain other payments to a payee who does not give a TIN to the payer. Certain penalties may also apply for providing false or fraudulent information.

**APPENDIX H
MOUNTING TEMPLATES**



MONITOR
DIRECTION

TRACKBALL ORIENTATION DIAGRAM

(VIEWED FROM UNDERSIDE OF CONTROL PANEL)

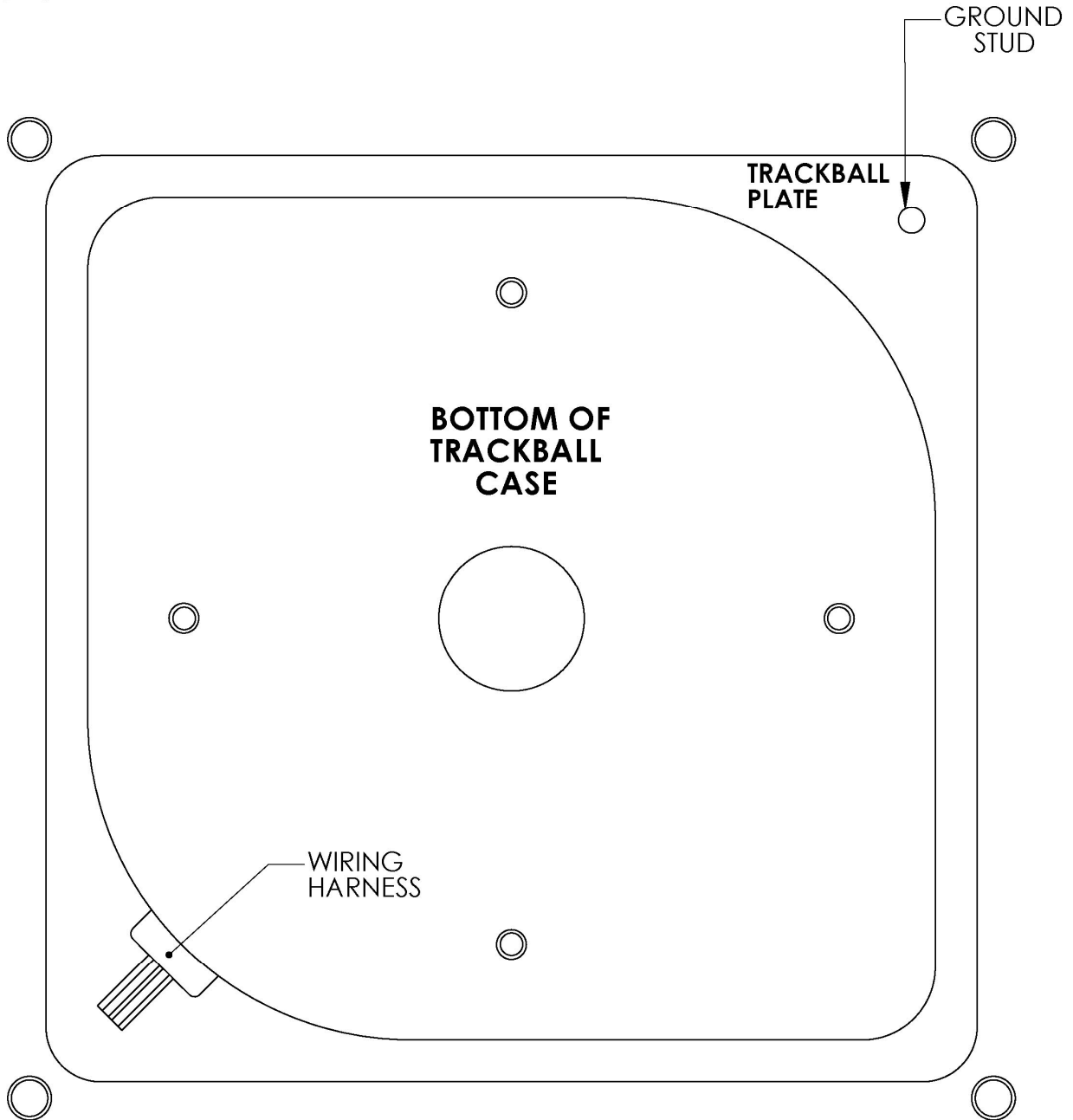

INSTALLATION NOTES:

- 1) THE WIRING HARNESS SHOULD POINT AWAY FROM THE MONITOR AND TO THE LEFT.
- 2) GROUND PIN SHOULD BE TOWARD THE MONITOR AND ON THE RIGHT SIDE.

TRACKBALL MOUNTING TEMPLATE

- ◆ TOOLS REQUIRED: Drill with 9/32" or 5/16" and 3/4" drill bits, Sabre saw, Scissors, Router

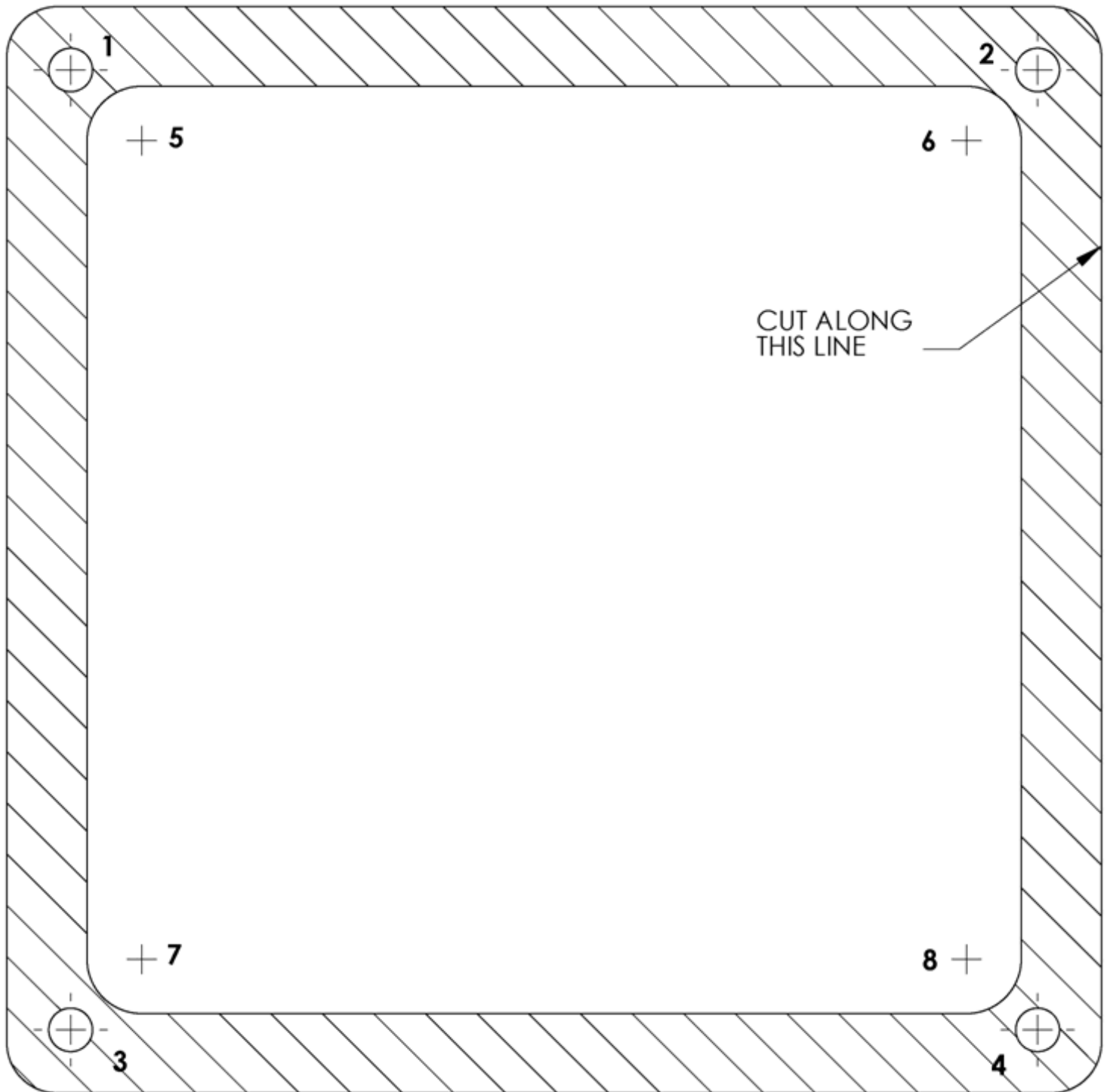

INSTRUCTIONS:

1. CUT THE TEMPLATE OUT WITH A PAIR OF SCISSORS ALONG THE NOTED LINE. TAPE THIS TEMPLATE TO THE TOP OF THE CONTROL PANEL AS FAR FROM THE MONITOR AS POSSIBLE, MAKING SURE THAT THE TRACKBALL CLEARS THE CABINET.
2. USING A SHARP OBJECT, MARK THE EIGHT (8) POINTS SHOWN HERE ON THE CONTROL PANEL. USING A PENCIL TRACE THE OUTSIDE OF THE TEMPLATE AND THEN REMOVE IT.
3. DRILL HOLES 1-4 WITH THE 9/32" OR 5/16" DRILL BIT
4. DRILL HOLES 5-8 WITH THE 3/4" DRILL BIT
5. ROUTE THE CROSSHATCHED REGION TO A DEPTH OF ABOUT .060" (ABOUT THE THICKNESS OF A PENNY).
6. USING THE SABRE SAW CUT OUT THE CENTER PORTION BY CUTTING BETWEEN HOLES 5-8.

LEFT BUTTON DRILL TEMPLATE

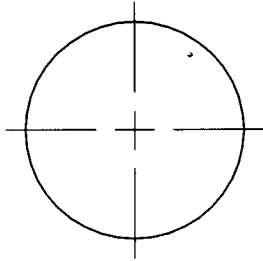
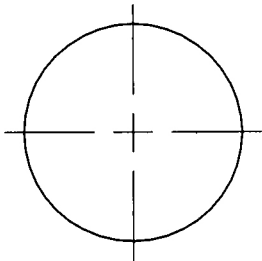

2

THE CENTER OF
BUTTON #2 SHOULD
BE LOCATED 2.75"
ABOVE, AND 9" TO
THE LEFT OF THE
CENTER OF THE
TRACKBALL.

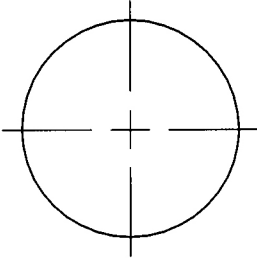

RIGHT BUTTON DRILL TEMPLATE

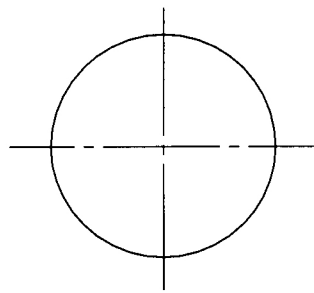

1

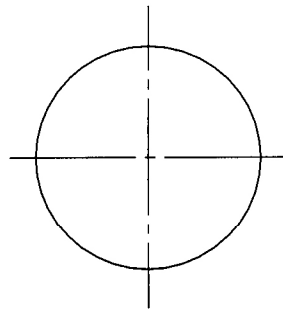
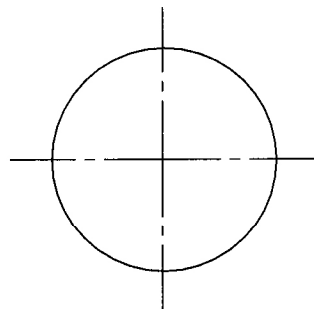
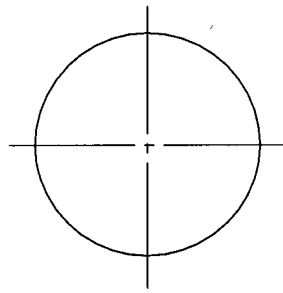

1) THE CENTER OF BUTTON #1 SHOULD BE LOCATED APPROX. 8" TO THE RIGHT OF THE CENTER OF THE TRACKBALL WITH THE BUTTONS CENTERED ABOUT THE TRACKBALL VERTICALLY.

2) FOR GOLDEN TEE FORE CABINETS THE #1 BUTTON HOLE SHOULD BE ALIGNED WITH THE EXISTING BACKSPIN BUTTON HOLE.

CARD READER MOUNTING TEMPLATE - SHEET A

FOR MODIFICATION OF INCREDIBLE TECHNOLOGIES' CABINET

1. CUT OUT AND POSITION TEMPLATE AGAINST COIN DOOR FLANGE AND AGAINST THE INSIDE CABINET WALL.
2. WHILE HOLDING TEMPLATE IN POSITION:
USING AN AWL, MAKE 4 MARKS FOR EACH OF THE PLATE MOUNTING HOLES AND MARK THE CENTER POINTS OF THE CUT OUT.
3. DRILL THE FOUR PLATE MOUNTING HOLES (3/16 DIA).
4. NEXT, DRILL A 3/8" DIA HOLE IN EACH OF THE FOUR CENTER MARKS FOR THE CUT OUT.
5. USING A SMALL SAW, CUT OUT THE AREA BETWEEN DRILLED HOLES.
6. MOUNT CARD READER TO PLATE AND ENTIRE ASSY. TO CABINET.

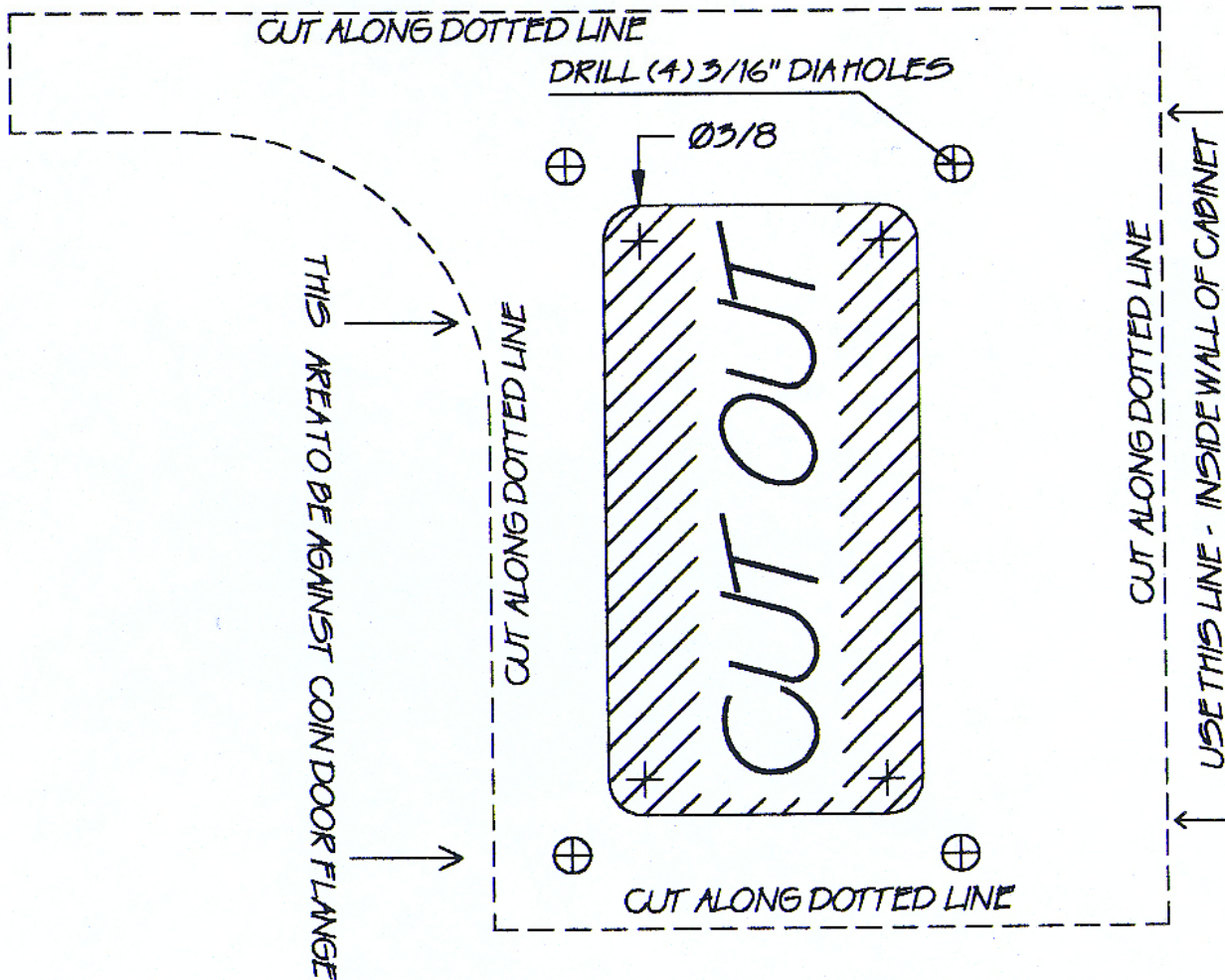

CARD READER MOUNTING TEMPLATE - SHEET B

CARD READER POSITIONING FOR MOST GAME CABINETS

1. CUT OUT TEMPLATE AS SHOWN (along dotted lines).
2. USING A TAPE MEASURE, LOCATE TOP OF CUTOUT TEMPLATE AT $25 \frac{5}{16}$ " FROM THE BOTTOM OF THE CABINET AND $\frac{3}{4}$ " FROM THE RIGHT SIDE OF THE CABINET.
3. WHILE HOLDING TEMPLATE IN POSITION:
USING AN AWL, MAKE 4 MARKS FOR EACH OF THE PLATE MOUNTING HOLES AND MARK THE CENTER POINTS OF THE CUT OUT.
4. DRILL THE FOUR PLATE MOUNTING HOLES ($\frac{3}{16}$ " DIA.).
5. NEXT, DRILL A $\frac{3}{8}$ " DIA. HOLE IN EACH OF THE FOUR CENTER MARKS FOR THE CUT OUT.
USING A SMALL SAW, CUT OUT THE AREA BETWEEN DRILLED HOLES.
6. MOUNT CARD READER TO PLATE AND ENTIRE ASSEMBLY TO CABINET.

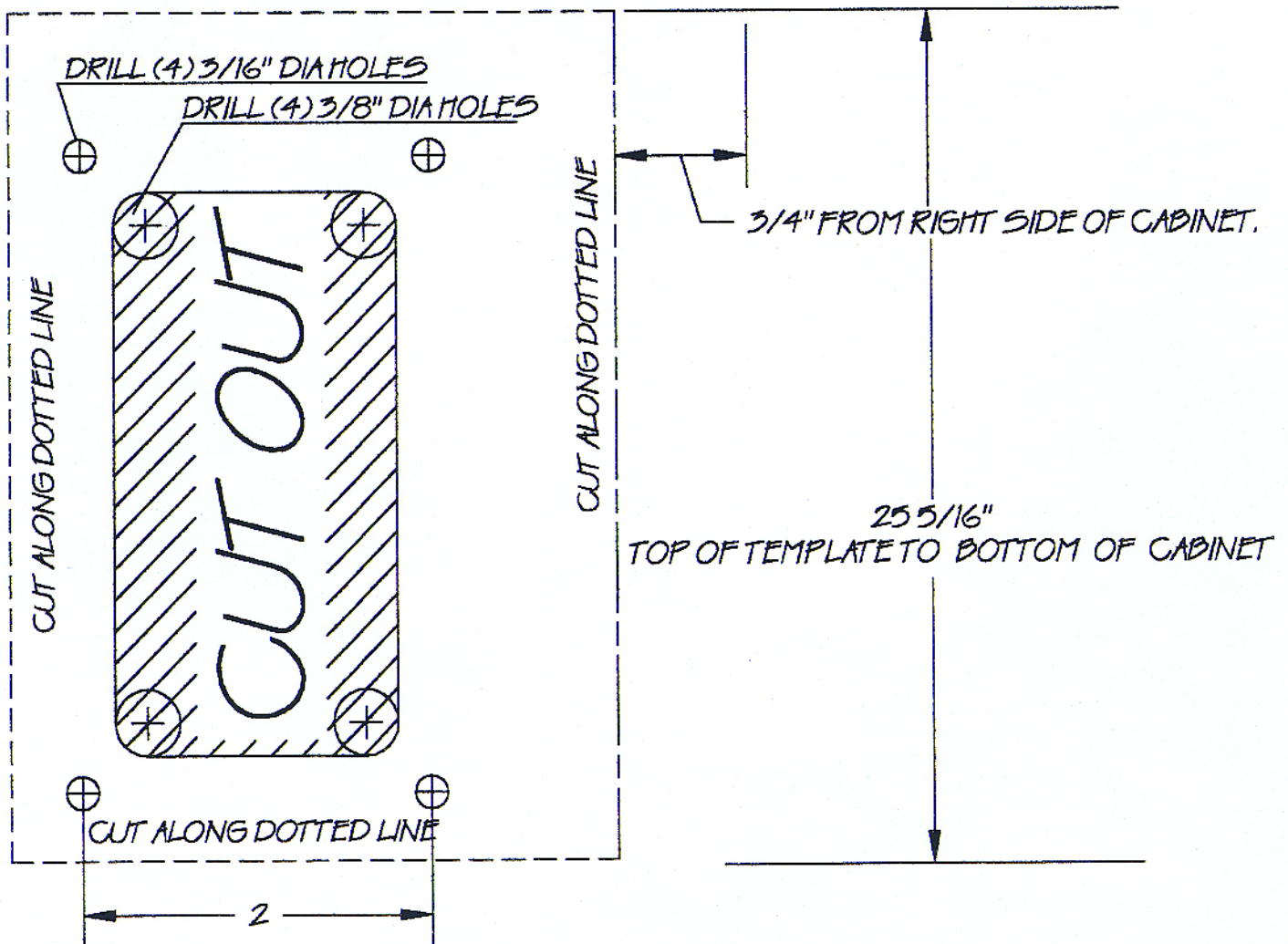

FAN INSTALLATION TEMPLATE - GENERIC CABINET

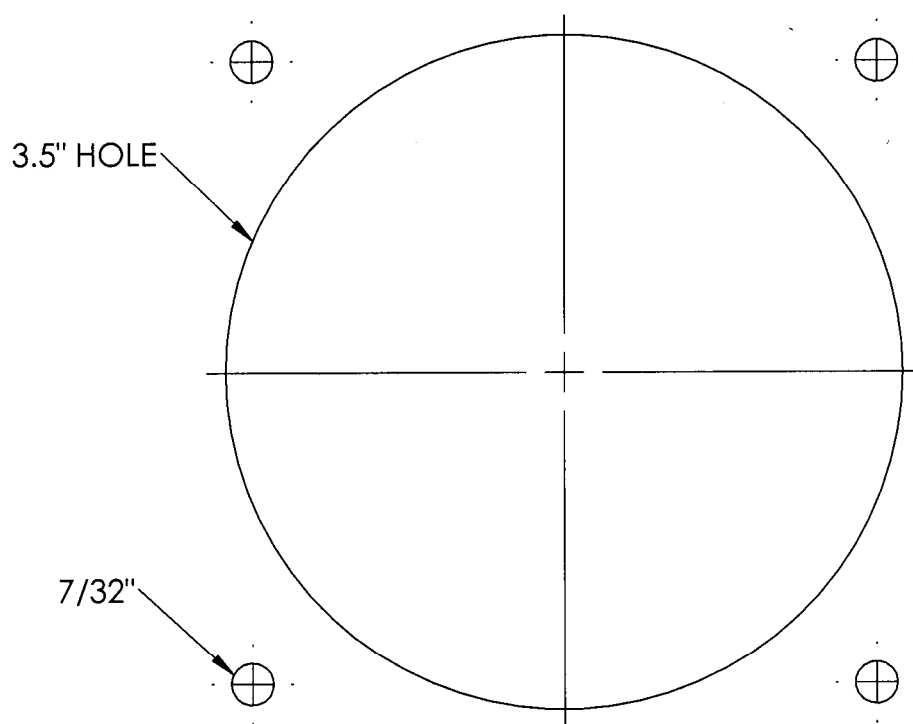

- 1) PLACE THIS TEMPLATE IN THE LOWER RIGHT BACK SIDE OF THE CABINET AND TAPE IT IN PLACE.
- 2) MARK THE CENTERS OF THE FOUR OUTSIDE HOLES AND THE LARGE CENTER HOLE USING AN AWL, NAIL, OR OTHER SHARP OBJECT. REMOVE THE TEMPLATE.
- 3) DRILL THE FOUR 7/32" HOLES CENTERED ON THE FOUR OUTSIDE MARKS.
- 4) DRILL THE CENTER HOLE USING A 3.5" HOLE SAW.

FAN INSTALLATION TEMPLATE - GT4

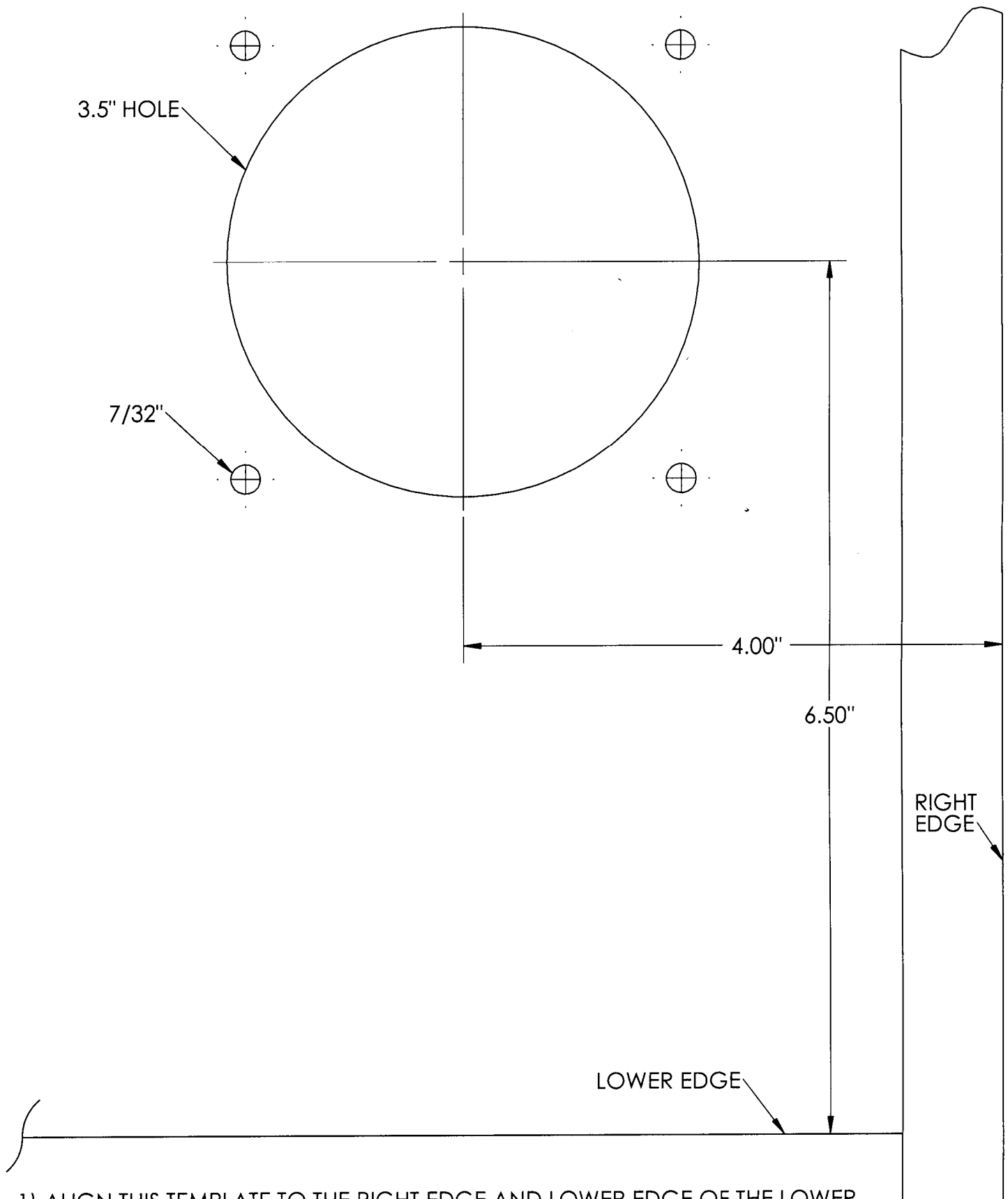

- 1) ALIGN THIS TEMPLATE TO THE RIGHT EDGE AND LOWER EDGE OF THE LOWER BACK SIDE OF THE CABINET AND TAPE IT IN PLACE.
- 2) MARK THE CENTERS OF THE FOUR OUTSIDE HOLES AND THE LARGE CENTER HOLE USING AN AWL, NAIL, OR OTHER SHARP OBJECT. REMOVE THE TEMPLATE.
- 3) DRILL THE FOUR 7/32" HOLES CENTERED ON THE FOUR OUTSIDE MARKS.
- 4) DRILL THE CENTER HOLE USING A 3.5" HOLE SAW.

Contact Information

IT Sales and Service

To purchase additional Golden Tee machines or any of IT's other fine products, please visit IT's website at www.itsgames.com and click on PRODUCTS!

For the phone numbers below, when prompted "if you know your party's extension you may enter it at any time", enter the three-digit number following the "x".

General Numbers

IT Sales Hotline:

800-262-0323 x383

847-870-7027 x383

Technical Support, Warranty & Repair:

Incredible Technologies, Inc.

800-262-0323 x380 or x381

847-870-7027 x380 or x381

847-454-9008 Fax

Parts and Customer Service:

Incredible Technologies, Inc.

800-262-0323 x386

847-870-7027 x 386

847-454-9156 Fax

Operator Services:

Incredible Technologies, Inc.

800-262-0323 x382

847-870-7027 x382

847-454-9155 Fax

Accounting

Incredible Technologies, Inc.

800-262-0323 x382

847-870-7027 x382

847-454-9007 Fax

IT Mailing Address:

Incredible Technologies, Inc.
200 Corporate Woods Parkway
Vernon Hills, IL 60061

ITNet Registration Fax Number

847-454-9155

Sales Fax Number

847-454-9156

General Fax Number: 847-870-0120
Tech Services Fax Number: 847-454-9008

IT Vendor Information

Mars Technical Service:

Phone: 800-345-8172

Happ Controls:

Phone: 888-289-4277



Incredible Technologies, Inc.

Phone (847) 870-7027 (800) 262-0323

www.itsgames.com