

Peta Jacobson's
Golden Tee '99™

OPERATION MANUAL

1 GETTING STARTED	2		
GAME PACKAGE CONTENTS.....	2		
<i>Non-Tournament Kit Version:</i>	2		
<i>ITS Tournament Version:</i>	2		
RECOMMENDED TOOLS AND SUPPLIES.....	2		
<i>Non-Tournament Kit Version:</i>	2		
<i>ITS Tournament Version:</i>	2		
2 INSTALLATION PREPARATION	2		
THE CABINET	3		
<i>Power Requirements</i>	3		
<i>Monitor Requirements</i>	3		
<i>Cabinet Selection</i>	3		
CONTROL PANEL.....	4		
<i>Trackball Preparation</i>	4		
<i>Button Preparation</i>	6		
GRAPHIC OVERLAYS.....	6		
<i>Control Panel Overlay Installation</i>	6		
<i>Function Labels Overlay Installation</i>	7		
<i>Marquee Installation</i>	7		
WIRING AND HARDWARE ASSEMBLY	7		
<i>Control Panel Assembly</i>	7		
<i>Printed Circuit Board (PCB)</i>	7		
<i>Wire Harness</i>	8		
<i>Power Wires</i>	8		
<i>Monitor Wires</i>	8		
<i>Speaker Wires</i>	8		
<i>SYNC</i>	8		
<i>Coin Doors, Test Switch, Service Button, and Volume Control Panel</i>	9		
<i>Mars Light Hookup (optional)</i>	9		
<i>Final Check</i>	9		
LED SIGN (ITS ONLY).....	10		
3 CONNECTING THE PHONE LINE (ITS ONLY)	10		
<i>Node Connections</i>	11		
<i>Phone Connections</i>	11		
4 INITIAL POWER-UP	12		
5 DIP SWITCH SETTINGS	12		
6 OPERATOR MODE.....	13		
VOLUME SETTINGS	14		
ITS COLLECTION REPORT AS DOLLARS (ITS ONLY)	14		
ITS COLLECTION REPORT AS COINS (ITS ONLY)	14		
OPERATOR ADJUSTABLES	15		
<i>Game Mode Selection</i>	15		
<i>Game Resets</i>	15		
<i>Attract Mode Sounds</i>	16		
<i>Credits and Coin Door Settings</i>	16		
<i>Delay Time Adjustment</i>	16		
<i>Coin Door Protection Menu</i>	17		
<i>Skill Level Adjustment (In Regular Play Only)</i>	17		
<i>Hole In One Contest Mode (In Regular Play Only)</i>	18		
<i>Three Hole Operator Event</i>	18		
GAME AUDITS.....	19		
<i>Display Coin Audits</i>	19		
<i>Display Game Selection Audits</i>	19		
<i>Number of Golfers and Holes Played</i>	19		
<i>ASPEN LAKE Audits</i>	20		
<i>COCONUT COVE Audits</i>	20		
<i>RANCHO SAGUARO Audits</i>	20		
<i>Reset Audits</i>	20		
TOURNAMENT MENU (ITS ONLY)	21		
<i>Tournament Operator Adjustables</i>	21		
<i>Display Tournament Audits</i>	22		
<i>Display Hardware Audits</i>	22		
<i>Display Timers</i>	22		
LEADERBOARD MENU.....	23		
<i>Display Leaderboard Menu</i>	23		
<i>Clear Leaderboard Menu</i>	24		
SYSTEM TESTS MENU	24		
<i>Video Screen Test</i>	24		
<i>Full GROM Checksum Test</i>	24		
<i>Fast GROM Checksum Test</i>	25		
<i>Video RAM Test</i>	25		
<i>Palette RAM Test</i>	26		
<i>Board Test</i>	26		
<i>Sound Test</i>	26		
<i>Control Panel Test</i>	27		
<i>Voltage Adjust Test</i>	27		
<i>Sign Test (ITS Only)</i>	27		
<i>Serial Port Test (ITS Only)</i>	27		
APPENDIX A			
GENERAL TROUBLESHOOTING	28		
PHONE LINE CONNECTION PROBLEMS (ITS ONLY).....	28		
VIDEO PROBLEMS.....	30		
SOUND PROBLEMS	31		
CONTROL PROBLEMS	31		
POWER-UP PROBLEMS.....	32		
LED SIGN PROBLEMS (ITS ONLY).....	33		
MISCELLANEOUS PROBLEMS	33		
APPENDIX B			
JAMMA HARNESS CONNECTION AND			
CABINET SCHEMATIC	34		
JAMMA HARNESS CONNECTION.....	34		
TRACKBALL HARNESS CONNECTION.....	34		
CABINET SCHEMATIC.....	35		
APPENDIX C			
ITS TOURNAMENT OVERVIEW.....	36		
<i>Game Highlights</i>	37		
<i>Tournament Highlights</i>	37		
<i>Networking Highlights</i>	37		
<i>Accounting Highlights</i>	37		
ITS GAME INITIALIZATION FORM (ITS ONLY)	38		
ITS DEBIT ACCOUNT FORM (ITS ONLY).....	38		
APPENDIX D			
ITS TOURNAMENT PROCEDURES	39		
OFFICIAL TOURNAMENT RULES	39		
BEGINNING A TOURNAMENT	40		
COLLECTION PROCEDURE	40		
ENDING A TOURNAMENT	41		
PRIZE CLAIM PROCEDURE	42		
TOURNAMENT ICONS	43		
APPENDIX E			
FREQUENTLY ASKED QUESTIONS ABOUT THE ITS.....	44		
APPENDIX F			
WARRANTY INFORMATION.....	48		

1 Getting Started

Game Package Contents

Non-Tournament Kit Version:

- (1) Printed Circuit Board (PCB) Assembly
- (1) Connecting Wire Harness (JAMMA)
- (1) Trackball Assembly w/Metal Plate
- (1) Trackball Cable Assembly
- (3) Button Assemblies
- (1) Marquee Styrene
- (1) Marquee Plexiglas
- (1) Control Panel Overlay
- (1) Set of Function Labels
- (1) Manual

ITS Tournament Version:

- (1) Golden Tee '99 Golf Tournament Cabinet
- (1) Tournament Operation Manual
- (1) Monitor Manual
- (1) Bill Acceptor Manual
- (1) 50 ft. Telephone Cable
- (1) Telephone Line T-Splitter
- (1) Envelope of important operator forms

Recommended Tools and Supplies

Non-Tournament Kit Version:

- Phillips and Slotted Screwdrivers
- Socket Set, Wire Cutters and Strippers
- Pliers or Channel Locks
- Electric Drill with 3/32", 1/4", and 7/16" Bits
- Chassis or Sheet Metal Punch
- Razor Knife and Sharp Blades
- Soldering Iron and 60/40 Resin Core Solder
- Assorted Fastening Hardware
- Heat Shrink Tubing (3/32", 1/8", and 3/16")
- Masking Tape or 4" Wire Ties

IF YOU DO YOUR OWN PAINTING, YOU'LL NEED THESE PAINT SUPPLIES:

- Air Brush or Paint Sprayer
- Paint Brush, Paint Roller and Pan
- Paint (and Primer)
- Sandpaper

ITS Tournament Version:

- Normal telephone outlet that connects to an outside phone line.
- Inexpensive telephone, used to test the line connection.
- Voltmeter - used to verify voltage on the PCB.

2 Installation Preparation

BEFORE YOU START.....

1. Check to see if all the needed parts have been included in your kit or tournament cabinet (See *Game Package Contents*)
2. Do you have the necessary tools? (See *Recommended Tools and Supplies*)
3. Do not work with any part of the system plugged in (lights, monitor, or power supply).

NOTE: (FOR TOURNAMENT OWNERS ONLY)

Your Tournament cabinet has been checked at the factory prior to shipping and should be ready to plug-in and play. However, connections or components often come loose during shipping. Make sure you check all of the connectors, wires and harnesses on your cabinet before turning the game on. You may skip to LED Sign on page 10.

Also, be sure to check the voltage level of the power supply from the circuit board. For best results, make sure the voltage reading is set to 5.2 volts on the circuit board, not on the power supply or the JAMMA connector. See *JAMMA Harness Connection* on page 34

The Cabinet

Power Requirements

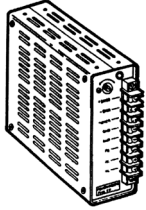

Make sure the game you have chosen to convert is able to supply all the required voltages for GOLDEN TEE '98.

+5 VDC 5 amps
+12 VDC 2 amps

WARNING!!!

The output level of many "regulated" switching power supplies actually vary with load. For this reason, the power supply from an old game may not be correctly adjusted for GOLDEN TEE '98. This makes the existing power supply inappropriate and hazardous to your new game. Therefore, it is very important to adjust the +5 VDC supply WITHOUT connecting the PCB, then readjusting it later, after the PCB has been installed. Measure power on the PCB, on an IC. Damage will occur if the power supply is outside the acceptable limits (between 4.8 and 5.5 VDC.)

Monitor Requirements

GOLDEN TEE '99 requires a monitor in a horizontal mount raster scan with negative composite SYNC. It can be difficult to change the monitor from vertical to a horizontal unit, therefore, installation will be easier if you choose a horizontal mount cabinet.

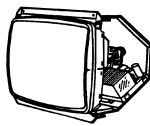

Cabinet Selection

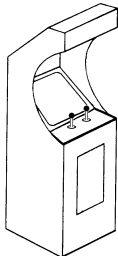

You can choose either a new cabinet or a used cabinet for your GOLDEN TEE '99 game. Reusing a cabinet is by far the most cost-effective way to maximize the return of your initial investment. In either case, all you need to provide is the cabinet with a power supply and monitor. We provide the rest. The end result is a new game at a very low cost.

NOTE:

It is recommended that a large control panel with a 25" monitor, like those on a 4-player cabinet, be used for your GOLDEN TEE '99.

When selecting a cabinet, keep this in mind:

A cabinet with a 25" monitor and a large control panel will allow you to mount the trackball farther from the monitor. This prevents players hands from hitting the monitor glass when rolling the trackball forward, and will earn better than a smaller control panel with a smaller monitor.

1. Remove the following from the cabinet:
 - Main Logic Board(s)
 - Control Panel
 - Monitor Plexiglas
 - Marquee
 - Cabinet Graphics
2. Thoroughly clean out your cabinet. Remove all the old buttons, joysticks and wires from the control panel. **DO NOT** remove monitor and speaker wires.
3. Remove the old graphics and adhesive from the control panel, and the side of the cabinet. Remove adhesive with solvent.
4. For a fresh look, painting is highly recommended. Spray painting gives a better finish, but if an air brush or paint sprayer is unavailable, a roller is second best. Remember to cover all exposed surfaces not to be painted.
5. Remember, spending time on the cabinet's appearance (i.e., marquee, control panel, and cabinet graphics) will raise your profits with the introduction of a new game package, especially if the cabinet looks clean and new.
6. The "new game look" should always apply to the inside of your game as well. A few wire ties and shrink tubing on your harness, some fastening hardware on your subassemblies, and a sweep with the vacuum cleaner will ensure that glitches do not occur.

Control Panel

Mounting the trackball correctly and securely is very important for the profitability of your new game. Follow these instructions carefully for mounting the trackball to: 1) a metal control panel; 2) a wooden control with routing; 3) or a wooden control panel without routing. (Refer to template inserts which came with your new kit.)

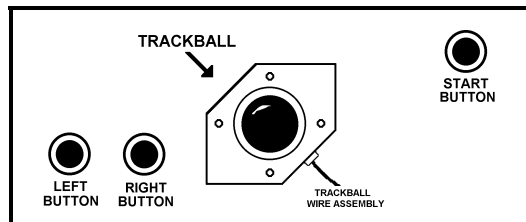

CONTROL PANEL LAYOUT
(Trackball MUST be centered on the control panel)

NOTE:

Installing the trackball as far away from the monitor as possible will prevent players hands from hitting the monitor glass when rolling the trackball forward.

NOTE:

The trackball mounting bolts may become loose over time, which may present a danger to your players. Make sure the bolt heads are flat and secure on the control panel surface and that the bolts are tightly secured. It is highly recommended that a nylon-insert locking nut be added and tightened against the existing nut of each carriage bolt to ensure a tight, secure fit.

Trackball Preparation



When making the hole for the trackball, follow the instructions, starting on the next page, for the type of control panel you will be using.

NOTE:

When installing the trackball, make sure the trackball is in the right orientation. (Refer to picture below.)

Trackball Orientation Diagram

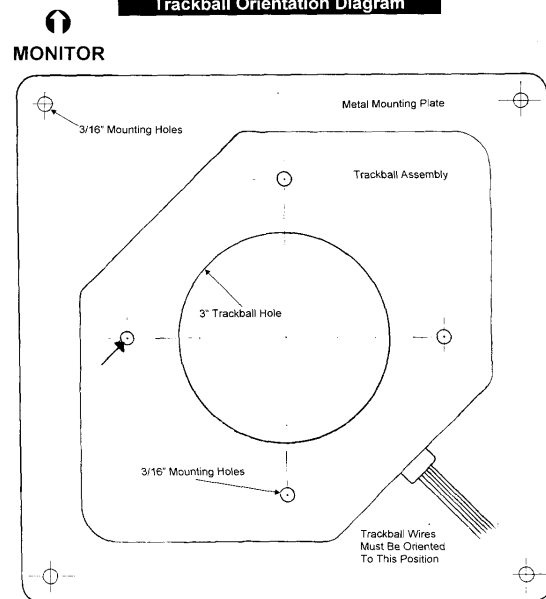

PLAYER

IMPORTANT:

Position the trackball as far away from the monitor as possible. Be sure the trackball is mounted straight and in the correct orientation.

TRACKBALL ORIENTATION (NOT DRAWN TO SCALE)

IMPORTANT!:

The supplied trackball comes equipped with a grounding cable. This cable *must be* connected to field ground to protect the trackball P.C. boards from becoming damaged by electro-static discharge.

To mount trackball to a metal control panel use Trackball Mounting Template #1

1. Fill any existing holes in the metal control panel.
2. Place and secure **TEMPLATE #1** to your control panel in the desired location.

NOTE: The trackball should be as far away from the monitor as possible.

3. Carefully drill the holes for the ball and the mounting bolts using the template as a guide.
4. Remove template and file down any rough edges.
5. See Graphic Overlays section on page 6 on how to install the graphics.
6. Mount the trackball under the control panel using the 4 carriage bolts. It is highly recommended that a nylon-insert locking nut be added to the nut of each carriage bolt to ensure a tight, secure fit. **Loose bolts can create unsafe conditions for game play.**

NOTE: Be sure the trackball is mounted as shown in the diagram on page 4.

NOTE: Do not over-tighten the trackball. It will warp and cause the trackball to not operate correctly.

NOTE: The supplied metal plate is not needed with metal control panels.

NOTE: Be sure to mount the trackball so as much of the ball is exposed as possible.

7. Securely fasten the trackball grounding wires to Field Ground in your cabinet. This step is important in reducing static buildup and discharge caused by the trackball.
8. If using Plexiglas on your control panel, it is highly recommended that a 3-1/2" hole be cut in the Plexiglas for the trackball. This allows for players to use the full height of the trackball. Carefully file and smooth the edges of the hole in the Plexiglas so players do not cut their hands when playing.

To mount trackball to a wooden control panel with routing capability use Trackball Mounting Template #2

1. Fill any existing holes in the wooden control panel.
2. Place and secure **Template #2** to your control panel in the desired location.

NOTE: The trackball should be as far away from the monitor as possible.

3. Carefully cut the hole for the trackball in the shape indicated on the template.
4. Drill the mounting holes indicated.
5. Next route out the shaded area indicated on **TEMPLATE #2**, 1/16" deep. Use a 1/2" Rabbeting Bit for best results. This is so the supplied metal plate will be flush with the control panel surface.
6. Remove template and file down any rough edges.
7. See Graphic Overlays section on page 6 on how to install the graphics.
8. Mount the trackball to the metal plate using the 4 carriage bolts supplied. Then mount the metal plate to the wooden control panel. It is highly recommended that a nylon-insert locking nut be added to the nut of each carriage bolt to ensure a tight, secure fit. **Loose bolts can create unsafe conditions for game play.**

NOTE: Be sure the trackball is mounted as shown in the diagram on page 4.

NOTE: Do not over-tighten the trackball. It will warp and cause the trackball to not operate correctly.

NOTE: Be sure to mount the trackball so as much of the ball is exposed as possible.

9. Securely fasten the trackball grounding wires to Field Ground in your cabinet. This step is important in reducing static buildup and discharge caused by the trackball.
10. If using Plexiglas on your control panel, it is highly recommended that a 3-1/2" hole be cut in the Plexiglas for the trackball. This allows for players to use the full height of the trackball. Carefully file and smooth the edges of the hole in the Plexiglas so players do not cut their hands when playing.

To mount trackball to a wooden control panel without routing capability use Trackball Mounting Template #3

1. Fill any existing holes in the wooden control panel.
2. Place and secure *Template #3* to your control panel in the desired location.

NOTE: The trackball should be as far away from the monitor as possible.

3. Carefully cut the hole for the trackball in the shape indicated on the template. The trackball should fit the hole shape exactly.
4. Drill the mounting holes as indicated.
5. Remove template and file down any rough edges.
6. Using the *Trackball Orientation Template*, cut a 3" hole in the Plexiglas overlay to fit over the trackball. Be sure to include holes for the buttons and all of the mounting bolts. Carefully file and smooth the cut edges so players do not cut their hands when playing.
7. See Graphic Overlays section on page 6 on how to install the graphics.
8. Insert the trackball into the newly cut hole. Place the Plexiglas overlay on top of the control panel. Place the supplied metal plate under the trackball and use the carriage bolts to secure it to the control panel. The metal plate below and the Plexiglas above will secure the trackball into position. It is highly recommended that a nylon-insert locking nut be added to the nut of each carriage bolt to ensure a tight, secure fit. **Loose bolts can create unsafe conditions for game play.**

NOTE: Be sure the trackball is mounted as shown in the diagram on page 4.

NOTE: Do not over-tighten the trackball. It will warp and cause the trackball to not operate correctly.

NOTE: Be sure to mount the trackball so as much of the ball is exposed as possible.

9. Securely fasten the trackball grounding wires to Field Ground in your cabinet. This step is important in reducing static buildup and discharge caused by the trackball.

Button Preparation

1. When making the holes for the buttons, **DO NOT use the Function Labels to outline any new holes.** The Function Labels are designed to fit right over the buttons when installed on the control panel. If the labels are used as a template the holes will be too big, and the buttons will fall through. Instead, use the labels as a guide to where you want to drill your new holes, and then cut a 1-1/8" hole in the center of where the labels are to be placed. **DO NOT stick the labels to the panel at this time.**
2. Drill or punch the holes marked for buttons or bolts. Use a chassis or sheet metal punch for best results on button holes.
3. Use a file to smooth any rough edges on the holes.
4. Fill any old and unused holes with wood, resin, or a metal plate.
5. It is recommended that you cover your control panel with Plexiglas. Now would be a good time to cut it to fit while the dimensions and tools are at hand.

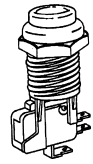

Graphic Overlays

GOLDEN TEE '99 comes equipped with graphics that will accommodate a variety of existing game cabinets.

Control Panel Overlay Installation

1. Make sure the control panel is clean and free from dust, grease, metal filings, and sawdust. The background overlay provided with the game is oversized to accommodate most control panel sizes. Center the background overlay on the control panel surface. Be sure to leave enough excess material above and below the control panel in order to trim it evenly.
2. Remove the protective backing from the background overlay. Center the background overlay over the control panel and place down gently, making sure to keep it square. Using your hands, press down firmly, starting from the center and smooth the background overlay outward, making sure all bubbles have been pressed out for a clean, flat surface.

- Using a sharp razor knife, trim any excess from the background overlay. Carefully pierce through the overlay above each control panel hole that you have marked. Cut out material covering the pre-drilled holes with the razor knife. Be sure to cut the background overlay above each hole and trim cleanly and evenly.

Function Labels Overlay Installation

Line up the supplied function labels with the corresponding control panel holes. Remove the backing and carefully press into place. Be sure they are straight. Attach the **HOOK/SWING reference diagram** above the trackball label. If your control panel is too narrow to fit the reference diagram, mount the diagram under the monitor glass on the bezel. Refer to the diagrams below.

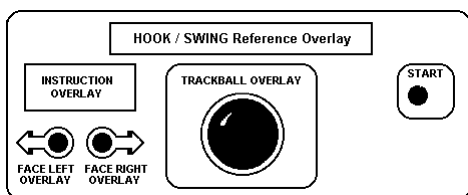

FUNCTION LABEL LAYOUT #1

or put the **HOOK/SWING Reference diagram** on the monitor bezel.



FUNCTION LABEL LAYOUT #2

Marquee Installation

If your cabinet needs a new marquee glass, determine the correct size and cut the Plexiglas (supplied) to fit. Using the old marquee glass as a template, center the Plexiglas on your new marquee graphics, making sure that all the printed images will be visible. Using a razor knife, score the new marquee deeply, following the edges of the old glass. Carefully break off the styrene. Be sure the light behind the marquee works and that the glass is clean on both sides. Now install the marquee graphics and glass securely.

Wiring and Hardware Assembly

REMEMBER! DO NOT WORK WITH ANY PART OF THIS SYSTEM PLUGGED IN (Lights, Monitor, or Power Supply).

NOTE:

All switch wires used in this game need to be wired to the normally open connection on the switches. Each switch requires a ground wire on the common connector and the appropriate control or switch wire on the other normally open connector of the switch.

Control Panel Assembly

- Install the trackball and buttons on the control panel by following the detailed instructions beginning on page 4. The two red buttons are used for FACE LEFT and FACE RIGHT. The white button is used as the START button.

NOTE:

If you want your new game to earn money, you must install the trackball correctly.

- If you are using Plexiglas for added protection, don't forget to place it on the panel before inserting the buttons.
- Wire the trackball and buttons using the *JAMMA Harness Connection and Cabinet Schematic* table on page 34. Connect the trackball using the supplied trackball cable into PLAYER 1 on the PCs.

IMPORTANT!:

The supplied trackball comes equipped with a grounding cable. This cable *must be* connected to field ground to protect the trackball P.C. boards from becoming damaged by electro-static discharge.

Printed Circuit Board (PCB)

Mount the PCB to the side of the cabinet with the connector toward the top of the drawer. This will keep the wire harness from slipping off due to vibration. Mark and drill pilot holes (3/32") onto the cabinet side, being careful not to drill through to the outside. Attach the PCB standoffs to the cabinet using wood screws and spacers, snug but not too tight or the board may warp or crack. Be sure the board is not being flexed in any way.

Wire Harness

WARNING!

Be sure that all power is OFF before connecting power supply.



1. If you are installing GOLDEN TEE '99 into a Dynamo cabinet with a pre-installed JAMMA harness, you will notice that it does not have a wire for the test switch. You will have to add a contact to the edge connector at the proper position (position 15). Some cabinets (Dynamo included) have only one coin switch input and the coin switches are wired together. Connect the designated wires to the coin switches separately.
2. Attach the wire harness connector to the PCB. Be sure it is mounted correctly.

WARNING!!!

Make sure you have identified PIN 1 on the connector before powering up. Plugging the JAMMA connector in backwards will cause damage to the PCB.

3. It is best to use connectors (not supplied) whenever joining a set of harness wires to a subassembly. If you choose to solder wires together, follow this procedure:
 - Strip off about 1/2" of insulation from the wire.
 - Slide a piece of heat-shrink tubing over the end.
 - Do not leave a lot of excess wire spooled up in your cabinet. Cut the wires to the length you need plus a few extra inches. Leave enough for proper cable dressing. Do not make it stretch across the inside of the cabinet.
4. Solder the new wire to the original wire. Use a straight in-line splice.

Power Wires

1. Connect the wires that are designated for your power supply. You will need a supply of +5 vdc, and +12 vdc. The +5 vdc must be regulated to within 5% (+ or - 0.25). The +12 vdc may be unregulated but should not stray too far or the sound may be affected. If the cabinet's supply does not provide these voltages, it will have to be replaced. A switching-type supply is recommended.
2. You will notice that you have more than one wire for each voltage. Use all wires supplied on the harness. This will ensure better power transmission and prevent overloading of the edge connector pads.
3. Tin all power supply wires before connecting them to the power supply. Loose strands may short out the supply. For best results, connect spade lugs to the ends of the power wires and attach to the screw terminals of the power supply.

Monitor Wires

You will be connecting the RED, GREEN, and BLUE video drives along with the composite SYNC and video GROUND wires.

Speaker Wires



Connect the speaker wires paying attention to their polarity.

NOTE:

If your cabinet has two speakers, connect both. If they are 8 or 16 ohm speakers, connect them in parallel, if they are 4 ohm, connect them in series.

Position speakers as far from the monitor as possible. If placed too close, the speaker's magnet may deflect the monitor and cause strange coloration, which can usually be corrected by degaussing the monitor. Make sure everything else in the cabinet is attached securely for the same reason.

SYNC

This is the recommended approach for a Wells-Gardener monitor and should work with some others as well.

If your monitor does not have a composite SYNC input but has separate horizontal and vertical SYNC inputs, try connecting the composite SYNC signal from the PCB to the negative horizontal SYNC signal on the monitor. This should produce a satisfactory result, although some adjustment of the monitor's SYNC controls may be necessary.

Coin Doors, Test Switch, Service Button, and Volume Control Panel

1. Wire the coin doors and the test / service switch(es) as per the *JAMMA Harness Connection and Cabinet Schematic* table on page 34.
2. Connect the door lamps to the +12 vdc supply. Some games have separate power supply outputs for the lamps.
3. Install a test switch somewhere convenient inside the coin door area. This switch allows you to enter adjustables, run diagnostics, and see or clear audits. Make it readily accessible through the coin door. Wire it to the Test wire on the JAMMA Harness.
4. Install a service switch (not included) somewhere convenient inside the coin door area. This switch allows you to give credits to players without affecting the game's credit audits or coin meters. Example: A player puts in a coin and gets no credit, the operator can then push the service button and a credit is given to the player without affecting the game's audits and coin meter.
5. GOLDEN TEE '99 has the ability to adjust volume at any time during a game. Install two push button switches (not included) inside the coin door for easy access. Connect the switches to the JAMMA harness. Refer to the *JAMMA Harness Connection and Cabinet Schematic* table on page 34.
6. GOLDEN TEE '99 is also capable of running a Mars Light or other external signal, which will be activated if the game is running a special Hole-In-One contest.

Mars Light Hookup (optional)

Equipment required

A MARS light police beacon and a 3 amp 120 volt AC solid state relay with a 2.5 to 8 volt control line.

1. Connect a wire from PIN 2 of the PCB's ticket connector to the positive control line of the relay.
2. Connect a wire from PIN 3 of the PCB's ticket connector to the negative control line of the relay.

WARNING!

Make sure all power is OFF before installation

3. The hot AC line in should connect to one side of the light and the return should connect to the AC input of the relay.
4. From the AC output of the relay, connect a wire to the other side of the light.

WARNING!

Make sure all wires and connections are securely fastened, with no loose strands of wire. Improper or sloppy connections can cause serious injury or fire.

5. The Hole-In-One contest is turned ON in the *Operator Adjustables* in order for the light to activate when a hole-in-one is made.

NOTE:

Mars Light will only work for sound PROMS 1.0 and above.

Final Check

1. Check the game inside and out for any imperfections. Secure any loose wiring or fastening hardware.
2. Make sure the coin door is tight and the coin mechs are well adjusted.
3. Make sure all assemblies are firmly attached. Anything that is not mounted securely will rattle when the game is played. This game makes use of low-frequency sounds which can cause any loose joints to rattle.

LED Sign (Tournament Version Only)

The LED message sign is folded back for safe shipping purposes. Before you start your game, lift the LED sign forward until it is in an upright position. Make sure the cables connecting the sign to the cabinet do not get caught or pinched in the access hole. Attach the metal support brackets, found inside the cash box, to the back of the sign and cabinet. This bracket will prohibit the sign from falling backward. Make sure to orient the bracket so the V-shaped notch lines up with the hinge on the bottom of the sign box. Use the supplied short screws to attach the top of the bracket to the sign box. Use the longer screws to attach the bracket to the cabinet.

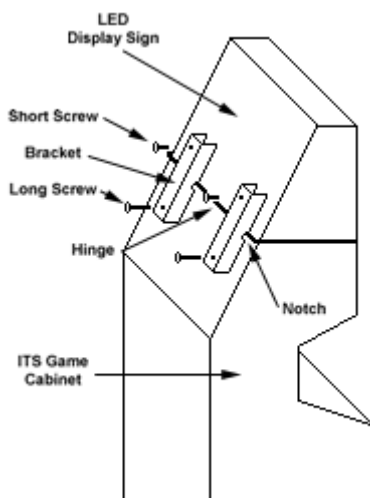

NOTE:

Make sure the brackets are oriented correctly. Mounting the brackets backwards or using the wrong screws will allow the mounting screws to drive too far into the sign box and may damage the sign's electronics.

3 Connecting The Phone Line

(Tournament Version Only)

In order for your game to join the tournament, you must connect the game to a regular telephone line. The ITS requires a regular phone line that gives a dial tone. Phone systems that are not direct outside lines may not work.

1. Set up your ITS-compatible Golden Tee '99 Golf cabinet as you would any other video game. Be sure the LED sign and modem are properly connected to the PCB and the modem is on. Use the illustrations on the next page to verify proper connections.
2. Make sure the supplied, long, round telephone cable is plugged into the phone jack marked LINE on the modem. Thread the other end of the cable through the mouse hole below the back door. Be sure to loop the cable through the cable clip for extra strain relief.
3. Connect the end of the long cable into any existing telephone jack. Use the included splitter if you are connecting to a jack already in use. If no jack is available, you will need to install a phone jack, preferably near the cabinet.
4. Turn on the game cabinet and watch the Attract mode. The game will automatically attempt an initialization call. Pay attention to the various screen messages, and listen carefully to the modem for a dial tone, dialing sounds and the modem connect sound as the game makes its call.
5. Automatic installation is complete when the screen displays a SUCCESSFUL message. If an unsuccessful message appears, enter Test Mode by pressing the button inside the coin door. A second attempt to call will begin when you exit Test Mode by pressing the START button. If your first few attempts to call are unsuccessful, check the Troubleshooting section in this manual.

NOTE:

If you are unable to get your game to complete a successful call, contact your distributor or the Incredible Technologies Technical Department.

6. After your successful phone call, the game is now connected to the Tournament System and ready for public play! Tournament information will appear on the LED sign and promotional materials will be sent from the ITS, for display at each location.

IMPORTANT:

Fill out the ITS Game Initialization Forms for each cabinet and location. Fax or mail the Initialization Forms to I.T. to validate your game. Your game will **NOT** access the tournament if these forms are not received.

Node Connections

If you are planning to place more than one tournament game in a location, you may want to connect them together so all of the ITS machines share the same phone line. Follow the directions below to correctly daisy-chain your tournament cabinets together.

ITS games can be connected together and share one phone line. All of your game cabinets will require operating modems. Connect the first game cabinet up to the phone line following the directions listed under *Connecting The Phone Line* on page 10.

From the first cabinet, connect the long round telephone cable, supplied with the game, to the jack on the modem marked PHONE. Connect the other end of this cable into the modem of the next cabinet in line. The cable connects to the jack marked LINE on the modem. If a third cabinet is to be connected, attach another telephone cable to the PHONE jack from the second machine and connect the other end to the LINE jack on the third machine. Repeat this sequence until all of your tournament machines are daisy-chained together.

All ITS-compatible games will have the ability to be connected together in a location. Even if each machine is a different game running a different tournament, only one phone line will be necessary for all of the data to be transferred.

NOTE:

Because the node connection is a daisy chain, it is very important that all connected units be in operation. If one of the nodes is turned off or out of service, the nodes connected after that machine will not transfer their data.

Phone Connections

Connecting to the PCB

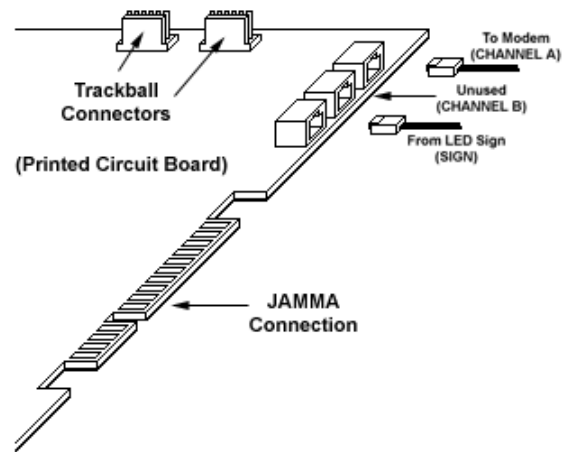

Connecting to the Modem

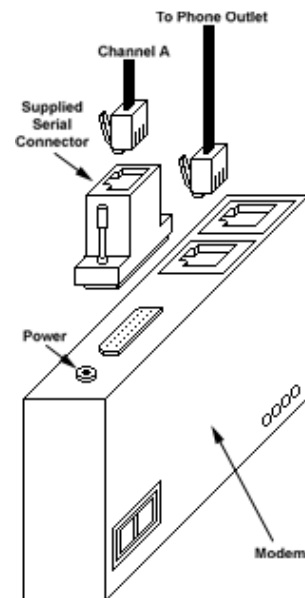

Connecting to the Wall

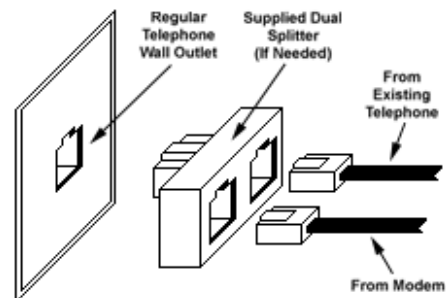

4 Initial Power-Up

1. Connect the JAMMA Harness.

WARNING!!!

Make sure the harness is plugged in correctly. Damage to the PCB will occur if the JAMMA connector is plugged in wrong.

2. Connect the supplied phone cable to a phone jack. *(Tournament Version Only)*
3. Plug in the game and turn it ON.
4. Look and smell for smoke (**TURN IT OFF IMMEDIATELY IF ANY IS NOTICED**).

NOTE:

Use the Voltage Adjust Test on page 27 to adjust your power supply. The ideal reading should be 5.2 volts on the circuit board. This is very important for your game to perform correctly. The voltage should be checked and adjusted regularly for best game performance.

5. Make sure the LED's on the PCB are flashing. If not, something is wrong, turn off the game.
6. Listen for sound. Sounds should be heard in the attract mode.
7. How is the picture? Is it centered? Is it too bright? Is it in focus? Adjust your monitor to get the best picture possible.

NOTE:

Check your monitor manual to make adjustments. Some test patterns are available through the game's system tests by pressing the Test switch. Use them when making any adjustments. (See System Tests Menu on page 24. Proper monitor adjustment is very important.)

8. Try all coin switches. Drop quarters or tokens through to check the coin mechs. Insert a dollar bill into the bill validator and listen for the credits to ring up. Make sure the game is adding credits. You can use the PLAYER CONTROL TEST by pressing the test switch and entering the SYSTEM TESTS MENU on page 24. Do all of the controls work? Try playing the game with the volume up and listen for rattling as you play. Tighten anything that is making noise.
9. Upon initial power-up, the game will initialize to factory default settings. These settings affect game elements such as number of credits per coin, difficulty settings, etc. The OPERATOR ADJUSTABLES MODE section will describe how to alter these settings and view the system audits or run system tests.
10. If you wish to automatically run a series of system tests, hold down the START button when you power up the game cabinet. The game will automatically perform the FAST GROM, VIDEO & PALETTE RAM and sound tests, and end on the player control test screen. This is a good, quick way to check the integrity of your PCB.

5 Dip Switch Settings

The SW1-Dip switches can be found on the main PCB near the JAMMA connector.

Dip switch 4 (ON): Always "ON" (DEFAULT)
Dip switch 4 (OFF): *** NOT USED ***
Dip switch 3 (ON): Normal Mode (DEFAULT)
Dip switch 3 (OFF): Cocktail Mode
Dip switch 2 (ON): One Trackball (DEFAULT)
Dip switch 2 (OFF): Two Trackballs (cocktail version)
Dip switch 1 (ON): Normal Game Play (DEFAULT)
Dip switch 1 (OFF): Operator Mode Menu

NOTE:

For Cocktail tables, dip switches 2 and 3 must be set to OFF.

There are also SW2-Dip switches near the flashing green LED. Switches #1 and #2 must be "ON" and switches #3 and #4 should be "OFF"

6 Operator Mode

To enter the **OPERATOR MODE MENU**, press the Test Button, located just inside the coin door. When the Test Button is pressed or SW1-DIP Switch 1 is flipped to the "OFF" position, the screen displays the OPERATOR MODE MENU.

NOTE:
If you used SW1-DIP switch 1 to enter the **OPERATOR MODE MENU**, you will need to flip SW1-DIP switch 1 back to the ON position in order to return to the game.

When in OPERATOR MODE, the game's software version and **ITS** ID Number are always displayed at the top of each screen.

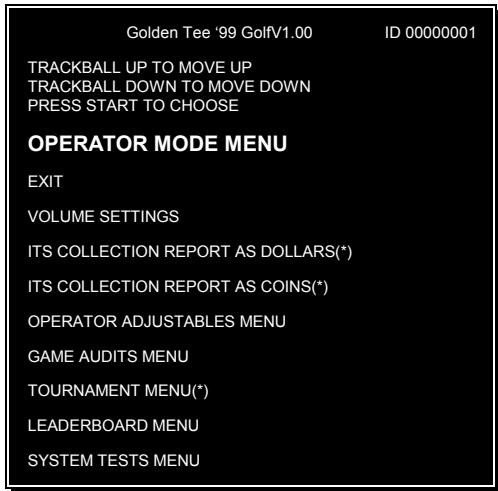

OPERATOR MODE MENU

The OPERATOR MODE MENU allows you to enter into several different areas:

VOLUME SETTINGS is used to adjust the volume of your game for your location.

ITS COLLECTION REPORT AS DOLLARS displays the current tournament coin audits, for use in separation of ITS fees from your collections. In this setting the audits are displayed in US dollars.

ITS COLLECTION REPORT AS COINS displays the current tournament coin audits, for use in separation of ITS fees from your collections. In this setting, the audits are displayed in total number of coins.

OPERATOR ADJUSTABLES is used for customizing your game for your location. Some of the features in Operator Adjustables are number of coins per game, sounds on or off when no one is playing, difficulty settings, etc. These do not effect tournament play.

GAME AUDITS allows you to check your game's overall earnings, game times, game scores, etc. The Audits can be reset through this menu as well.

TOURNAMENT MENU offers adjustables and settings for low-level tournaments settings.

LEADERBOARD MENU allows you to view the top scores on the Leaderboard for each golf course. *For Regular play only.*

SYSTEM TESTS verifies the operation of the hardware, controls, and monitor through easy and automatic procedures accessed through these menus.

Menu items can be highlighted rolling the trackball Up or Down. The FACE LEFT and FACE RIGHT buttons highlight menu items as well. To select a highlighted item, press the START button.

To exit any of these tests and return the game to its normal state, use the trackball or FACE LEFT and FACE RIGHT buttons to highlight the line that says EXIT, and press the START button.

COLOR KEY NOTE:
For easy identification, all test screens have been color coded. Items displayed in GREEN are the Menu titles. This is the name of the menu that is currently displayed. Items appearing in YELLOW are the menu's instructions. The BLUE items are choices available in this menu. The WHITE item is the selection that is currently highlighted. If RED is ever displayed, there is a problem with that item and it should be corrected.

Volume Settings

The *Volume Settings* screen is used to adjust the sounds that are heard during game play.

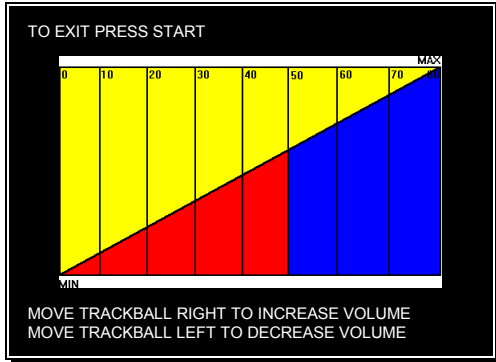

VOLUME SETTINGS SCREEN

When this screen appears, music will play. Move the trackball to the right to increase the game's sounds and music. Rolling the trackball to the left will make the game sounds softer. When you have adjusted the sounds to the appropriate volume, press the START button to exit back to the main menu.

Your cabinet also comes equipped with volume increase/decrease push buttons, located inside the coin door.

ITS Collection Report As Dollars (Tournament Version Only)

Use this screen to assist in collections during tournaments.



ITS COLLECTION REPORT AS DOLLARS SCREEN

RESET COLLECTION COUNTS is used to erase all of the collection counts stored in memory.

TOTAL DOLLARS displays the total number of dollars on both the tournament and regular games, since these audits were last reset.

ITS PORTION displays the number of valid tournament games on your machine, times the ITS fee. Separate this amount from your collection before you make your split. Deposit this amount into your debit account on a timely basis, to ensure proper funds.

OPERATOR/LOCATION displays the total dollars collected, minus the ITS portion. This is the amount of your collection that you may split with your location.

ITS Collection Report As Coins (Tournament Version Only)

Use this screen to assist in collections during tournaments.



ITS COLLECTION REPORT AS COINS SCREEN

TOTAL COINS displays the total number of coins on both the tournament and regular games, since these audits were last reset.

ITS PORTION displays the number of valid tournament games on your machine, times the ITS fee. Separate this amount from your collection before you make your split. Deposit this amount into your debit account, to ensure proper funds.

OPERATOR/LOCATION displays the total coins collected, minus the ITS portion. This is the amount of your collection that you may split with your location.

NOTE:

This collection report is exactly the same as **COLLECTION REPORT AS DOLLARS**, except that the earnings are represented as a total coin count rather than a dollar value.

Operator Adjustables

The **OPERATOR ADJUSTABLE MENU** is accessed through the OPERATOR MODE MENU.

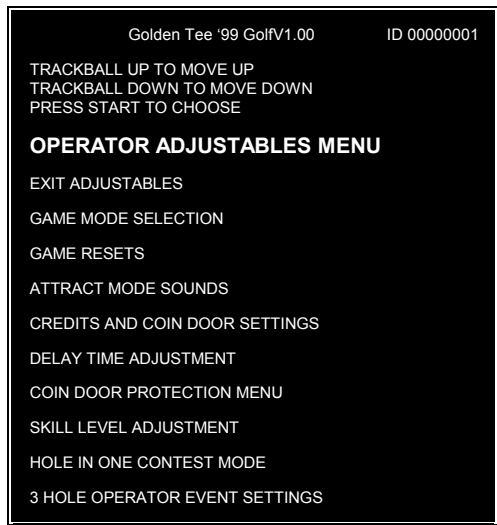

OPERATOR ADJUSTABLES MENU SCREEN

There are many customizing procedures that you can control. Below is a brief description of each adjustable function and what the screen looks like when displayed. Remember, to select an item from any menu, use the trackball to highlight the item in purple, and then press the START button.

Game Mode Selection

This menu allows you to place the game in standard COIN MODE, or choose FREE PLAY.



GAME MODE SELECTION SCREEN

In **COIN MODE**, the game will only work if coins are deposited into the game.

In **FREE PLAY**, coins are not needed for play, and the START button is always active.

IMPORTANT:

If **FREE PLAY** is set to ON when a tournament is in progress, your machine will not allow tournament play.

Game Resets

The **GAME RESETS** menu will cancel or zero out any custom features or bookkeeping figures that are no longer wanted.

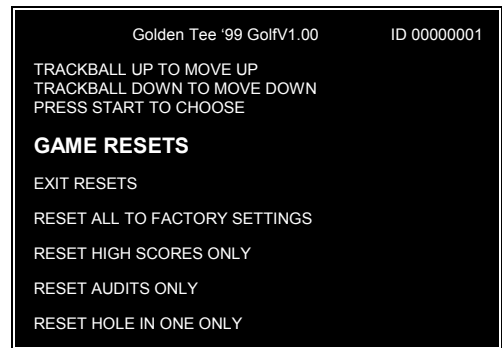

GAME RESETS MENU SCREEN

RESET ALL TO FACTORY SETTINGS will change the game back to the way the game was preset when new. Any custom features such as Free Play and Skill Levels will be changed back to the original settings set at the factory.

RESET HIGH SCORES ONLY is used to erase all of the high scores stored in memory.

RESET AUDITS ONLY is used when all of your bookkeeping and statistics have been gathered from the Audits section, and are no longer needed. If you like to gather all of your accounting information each week, or after each collection, it is a good practice to reset all of the audits so your coin count will match the audit information.

RESET HOLE IN ONE ONLY is used to erase all of the Hole-In-Ones that have occurred in the game.

Attract Mode Sounds

This menu is used to adjust the sounds that are heard while no one is playing the game.

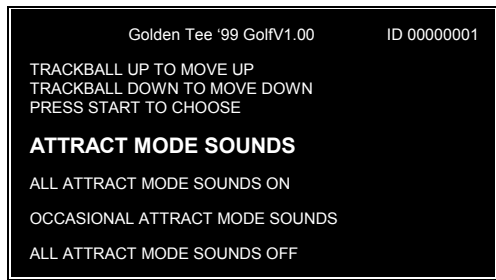

ATTRACT MODE SOUNDS MENU SCREEN

ALL ATTRACT MODE SOUNDS ON will play sounds during every attract cycle.

OCCASIONAL ATTRACT MODE SOUNDS plays sounds about every ten to twelve times the attract mode is repeated.

ALL ATTRACT MODE SOUNDS OFF will not allow any sounds to be played during the attract mode.

Credits and Coin Door Settings

This menu allows you to change the number of coins needed to play GOLDEN TEE 3-D GOLF.

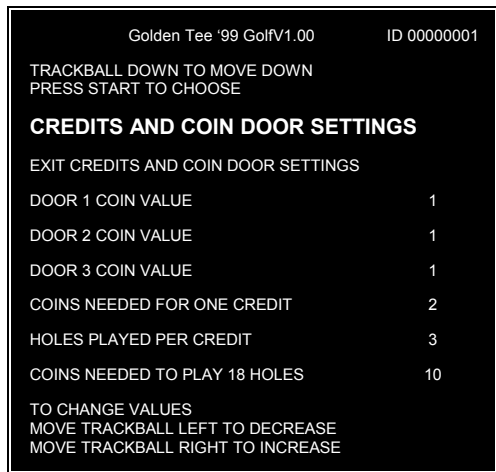

CREDIT AND COIN DOOR SETTING SCREEN

You can set each door to different coin values by highlighting **DOOR 1 COIN VALUE** for coin door 1, **DOOR 2 COIN VALUE** for coin door 2, etc.. Moving Trackball left or right will change the number of credits that each coin represents.

COINS NEEDED FOR ONE CREDIT..... To award a game credit, the player will need to insert an adjustable number of coins.

HOLES PLAYED PER CREDIT..... This defines the number of holes the player is given for each credit. This value can range from 1 to 3 holes.

COINS NEEDED TO PLAY 18 HOLES..... To play an entire 18 holes at a reduced cost to the player, you can set this value to something less than the cost of buying holes as described above. The default is 10 coins for 18 holes. This is a savings of 2 coins, at a rate of 2 coins for 3 holes. The player will need to insert all 10 coins at the start of a game to take advantage of this discount feature.

Delay Time Adjustment

This allows for changing the delay of game time.

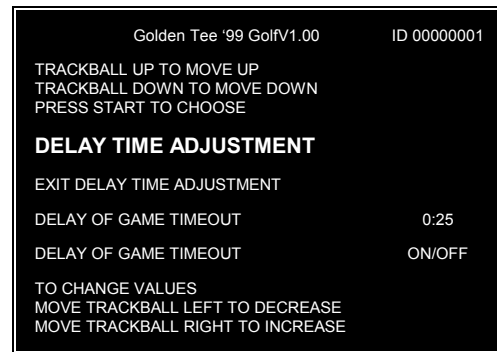

BUTTON CONFIGURATIONS SCREEN

DELAY OF GAME TIMEOUT (1)The game will give the player a penalty stroke if they have not swung the club after this amount of time.

DELAY OF GAME TIMEOUT (2) ... The TIMEOUT can be disabled by selecting "OFF" - We recommend leaving this "ON" so the game will return to the attract mode if a player walks away from a game in progress.

Coin Door Protection Menu



COIN DOOR PROTECTION MENU

COIN DOOR PROTECTION is implemented by monitoring the coin switch pulse width. A pulse longer than the **MAXIMUM COUNT** sets the game alarm counter. Each count represents about 4 milliseconds.

If two game alarms occur then the game halts and displays a coin failure message. Any unused credits in the game are cleared.

A count of good coin drops is kept and each time the **GOOD COIN COUNT** is reached the game alarm counter is cleared. This allows an occasional coin switch glitch to be tolerated.

A count of all switch alarms for each coin door is also kept. These counters can be cleared by selecting **RESET COIN DOOR ALARM COUNTS** and **RESET COIN SWITCH COUNTS**.

NOTE:

Coin mechanisms and bill acceptors vary widely. Test your game thoroughly with the coin protection ON to make sure the software is compatible with your hardware.

Skill Level Adjustment

(In Regular Play Only)

Golden Tee '99 Golf allows for changing the level of skill needed to play the game. This feature is good for locations with younger or novice players who are less skilled at the game, or expert or accomplished players who demand a greater challenge.

NOTE:

The skill level adjustment will only affect regular play. Skill level on all Tournament games is controlled by the ITS, so every machine plays the same.



SKILL LEVEL ADJUSTMENT SCREEN

To set the game to an easy skill level, highlight... **SKILL LEVEL 1 - EASIEST**.

To set the game to a difficult skill level, highlight... **SKILL LEVEL 5 - HARDEST**.

SKILL LEVEL 2, SKILL LEVEL 3, and SKILL LEVEL 4 are settings between the easiest and hardest levels. Sometimes it is best if the skill level is adjusted gradually over a period of time.

NOTE:

This menu will not affect tournament play. The skill level of each tournament is set by the ITS and is the same on every tournament machine.

Hole In One Contest Mode

(In Regular Play Only)

The **HOLE IN ONE CONTEST MODE** can be used if you or your location wants to give away prizes for a hole-in-one during regular play.



HOLE IN ONE CONTEST MODE SCREEN

Setting the **HOLE-IN-ONE CONTEST "ON"** will cause a loud siren and fanfare to go off if a hole-in-one is made. The hole-in-one message can be altered depending on your type of contest.

HOLE IN ONE CONTEST - WIN IMMEDIATELY will display a "YOU HAVE WON" message.

HOLE IN ONE CONTEST - QUALIFY TO WIN will display a "YOU HAVE QUALIFIED" message.

This feature will only work in regular play. Hole-in-ones are handled differently during tournament play.

NOTE:

Unless you are running your own special contest, apart from ITS Tournaments, this setting should remain *OFF*. Players and locations can become confused when this message appears during Regular Play, especially while a Tournament is in progress.

Three Hole Operator Event

Golden Tee 99 comes with a new feature that allows for in-house league or tournament play. This feature sets up a 3-hole course for head-to-head competition. 1 to 4 Players select a course, and a random selection of 3 different holes becomes available for play.

After the 3 holes are played, the final scores are displayed. Great Shot Points and Longest Drive are used as tie-breakers. This screen will be displayed until an official presses the start button. Next the course record screens will appear.

You can run this event in many different ways. You can have a single elimination system, a winner stays, loser pays system, a best of 3 system, etc. The 3-hole feature encourages fast play and allows for a large number of challengers.



3 HOLE OPERATOR EVENT SCREEN

To activate the 3 Hole Event, highlight 3 HOLE OPERATOR EVENT SETTINGS on the Operator Adjustables screen.

Highlight 3 HOLE OPERATOR EVENT and spin the trackball to the right to change OFF to ON. OFF deactivates the 3-hole event and allows regular play. ON activates the 3-hole event and will NOT allow regular play. Online ITS Tournament play is NOT available while the game is in this setting.

You may want to change the coins needed to play in the 3-hole event. Highlight COINS PER PLAYER and move the trackball to the left or right to adjust the number of coins needed to begin a 3-hole event game. The default setting is 2.

Game Audits

The **GAME AUDITS MENU** will supply you with a detailed accounting of helpful and informative bookkeeping and statistics. It can be accessed through the **OPERATOR MODE MENU**.

Golden Tee '99 GolfV1.00	ID 00000001
TRACKBALL UP TO MOVE UP TRACKBALL DOWN TO MOVE DOWN PRESS START TO CHOOSE	
GAME AUDITS MENU	
EXIT AUDITS	
DISPLAY COIN AUDITS	
DISPLAY GAME SELECTION AUDITS	
NUMBER OF GOLFERS AND HOLES PLAYED	
ASPEN LAKE AUDITS	
COCONUT COVE AUDITS	
RANCHO SAGUARO AUDITS	
RESET AUDITS	

GAME AUDITS SCREEN

Display Coin Audits

When you choose to review the coin audits, the *Display Coin Audits* screen will appear.

Golden Tee '99 GolfV1.00	ID 00000001
PRESS START TO EXIT	
DISPLAY COIN AUDITS	
COIN DOOR 1 COINS	XX
COIN DOOR 2 COINS	XX
COIN DOOR 3 COINS	XX
TOTAL COINS	XX
COINS TO ITS	XX
TOURNAMENT GAMES PLAYED	XX
REGULAR GAMES STARTED	XX
SECONDS PER COIN	XX

DISPLAY COIN AUDITS SCREEN

Display Game Selection Audits

This menu will show the audits for each game selection.

Golden Tee '99 GolfV1.00	ID 00000001
PRESS START TO EXIT	
DISPLAY GAME SELECTION AUDITS	
STROKE GAMES	XX
SKINS GAMES	XX
ASPEN LAKE COURSE	XX
COCONUT COVE	XX
RANCHO SAGUARO	XX
FORWARD ONLY STROKES	XX

DISPLAY GAME SELECTION AUDITS SCREEN

Number of Golfers and Holes Played

This menu displays how many games were played by 1, 2, 3, or 4 players and how many holes were played during a game.

Golden Tee '99 GolfV1.00	ID 00000001
PRESS START TO EXIT	
NUMBER OF GOLFERS AND HOLES PLAYED	
TOTAL 1 GOLFER GAMES	XX
TOTAL 2 GOLFER GAMES	XX
TOTAL 3 GOLFER GAMES	XX
TOTAL 4 GOLFER GAMES	XX
TOTAL 1-8 HOLE GAMES	XX
TOTAL 9-17 HOLE GAMES	XX
TOTAL 18 HOLE GAMES	XX
TOTAL FULL GAMES STARTED	XX

NUMBER OF GOLFERS AND HOLES PLAYED SCREEN

ASPEN LAKE Audits

This menu displays the audits for the ASPEN LAKE course.

Golden Tee '99 GolfV1.00	ID 00000001
PRESS START TO EXIT	
ASPEN LAKE AUDITS	
TOTAL GAMES	XXX
TOTAL HOLES PLAYED	XXX
AVERAGE HOLES PER GAME	XXX
TOTAL STROKES	XXX
TOTAL PUTTS	XXX
TOTAL WATER OR UNPLAYABLE BALLS	XXX
TOTAL OUT OF BOUNDS SHOTS	XXX
TOTAL DELAY OF GAMES	XXX

ASPEN LAKE AUDITS SCREEN

RANCHO SAGUARO Audits

This menu will display the audits for the RANCHO SAGUARO course.

Golden Tee '99 GolfV1.00	ID 00000001
PRESS START TO EXIT	
RANCHO SAGUARO AUDITS	
TOTAL GAMES	XXX
TOTAL HOLES PLAYED	XXX
AVERAGE HOLES PER GAME	XXX
TOTAL STROKES	XXX
TOTAL PUTTS	XXX
TOTAL WATER OR UNPLAYABLE BALLS	XXX
TOTAL OUT OF BOUNDS SHOTS	XXX
TOTAL DELAY OF GAMES	XXX

RANCHO SAGUARO AUDITS SCREEN

COCONUT COVE Audits

This menu displays the audits for the COCONUT COVE Audits course.

Golden Tee '99 GolfV1.00	ID 00000001
PRESS START TO EXIT	
COCONUT COVE AUDITS	
TOTAL GAMES	XXX
TOTAL HOLES PLAYED	XXX
AVERAGE HOLES PER GAME	XXX
TOTAL STROKES	XXX
TOTAL PUTTS	XXX
TOTAL WATER OR UNPLAYABLE BALLS	XXX
TOTAL OUT OF BOUNDS SHOTS	XXX
TOTAL DELAY OF GAMES	XXX

COCONUT COVE AUDITS SCREEN

Reset Audits

This menu will reset your audits.

Golden Tee '99 GolfV1.00	ID 00000001
TRACKBALL UP TO MOVE UP TRACKBALL DOWN TO MOVE DOWN PRESS START TO CHOOSE	
RESET AUDITS	
NO RESET AUDITS	
RESET AUDITS	

RESET AUDITS SCREEN

If you wish to set all of the game audits (described above) back to zero, highlight **RESET AUDITS** from this menu and press the START button. The screen will briefly display **AUDIT RESET**. Be careful, because once you have reset the Audits, the data is lost forever.

If you change your mind and decide not to reset the audits to zero, highlight **NO RESET AUDITS** and you will exit this screen without making any changes.

Tournament Menu (Tournament Version Only)



TOURNAMENT MENU SCREEN

Select **TOURNAMENT OPERATOR ADJUSTABLES** to enter into a menu of tournament settings and options. Most of these settings will not be necessary for normal tournament access and phone connections, and should be left at the factory settings as shown on the screen displayed on page 21.

DISPLAY TOURNAMENT AUDITS displays detailed tournament audits on the tournament games played on the machine. Most of these audits are not necessary for routine information and collection purposes. This information may be used to help determine possible tampering or game problems.

DISPLAY HARDWARE AUDITS displays the voltage readings for the PCB during initial power up of the game and during play of the game.

DISPLAY TIMERS displays time settings that your machine is currently using. These settings are set by the **ITS** via modem. It also displays game ID and serial numbers.

Tournament Operator Adjustables

Most of these settings will not need to be changed for normal tournament access and phone connections in most locations. The settings should remain as shown in the screen display below.



TOURNAMENT OPERATOR ADJUSTABLES MENU

FORCE TOURNAMENT UPLOAD may be used if you need to force a phone call to the **ITS**. To force a call, highlight **FORCE TOURNAMENT UPLOAD** using the trackball. Then move the trackball to the right to display YES. When you exit out of Test Mode, the game will automatically make a phone call attempt. If the call is successful, this setting will default back to NO. If the call is not successful, the game will continue to call periodically until a successful call is made.

Some phone systems or companies may require an initial prefix, such as "9", before dialing. Highlight **OUTSIDE LINE ACCESS NUMBER** to select your desired prefix. Moving the trackball left or right will increase or decrease the number. When the desired number is displayed, press the **START** button. Zero means no prefix is used.

Some phone systems or companies may require a delay before dialing in order to connect to a dial tone. Highlight **OUTSIDE LINE ACCESS DELAY** and move the trackball left or right to select the desired delay. The number represents seconds. When the desired delay time is displayed, press the **START** button. The default delay is 2.

Some older locations may still use rotary, or pulse phone systems. You can change the game to accept rotary phone lines by highlighting **ROTARY DIAL PHONE LINE** and then moving the trackball to the right to change the setting to YES. If your location uses the more common tone lines, make sure this setting is set to NO.

MODEM CONNECT TIMEOUT is used to adjust the amount of time the modem remains on line in order to complete a phone call. If you notice your game timing out before a connected call is completed, you may wish to increase this setting, to allow for longer connect time. The default setting is 1:30.

DISPLAY UPLOAD DIAGNOSTICS will display debugging code on the screen during a phone call. This setting should remain on NO.

DISABLE ITS ACCESS will completely disable the game from trying to make a call. To avoid losing your tournament capability, this setting should remain on NO.

DISABLE MODEM CONNECTION is used at the factory during production and should remain on NO.

Display Tournament Audits

This screen shows a detailed history of tournament activity on your machine. Normally, you will not need to access this screen. These audits can *not* be reset by the operator. At the start of each tournament, this audits screen is reset to zero by the ITS. You can use this screen to verify your total ITS collections, and verify any power loss or reset claims by players.

Golden Tee '99 GolfV1.00		ID 00000001
DISPLAY TOURNAMENT AUDITS		
TOTAL GAMES STARTED	XXX	
TOTAL GAMES COMPLETED	XXX	
TOTAL GAMES PLAYER QUIT	XXX	
TOTAL GAMES TIMED OUT	XXX	
TOTAL GAMES POWER LOSS	XXX	
TOTAL GAMES RESET LOSS	XXX	
TOTAL GAMES BELOW CUTOFF	XXX	
TOTAL NAMES ENTERED	XXX	
TOTAL NAMES DROPPED	XXX	
TOTAL NAMES POWER LOSS	XXX	
TOTAL NAMES RESET LOSS	XXX	
TOTAL ITS GAMES BILLED	XXX	
TOTAL ITS COIN	XXX	

DISPLAY TOURNAMENT AUDITS SCREEN

Display Hardware Audits

This screen displays various voltage readings that your PCB is at during initial power up and play of the game.

Golden Tee '99 GolfV1.00		ID 00000001
PRESS START TO EXIT		
DISPLAY HARDWARE AUDITS		
POWER ON POWERUPS	XX	
RESET POWERUPS	XX	
VOLTAGE OK POWERUPS	XX	
VOLTAGE LOW POWERUPS	XX	
VOLTAGE HIGH POWERUPS	XX	
VOLTAGE OK GAMES	XX	
VOLTAGE LOW GAMES	XX	
VOLTAGE HIGH GAMES	XX	

DISPLAY HARDWARE AUDITS SCREEN

Display Timers

This screen displays various time settings that your machine is currently using. These settings are set by the ITS via modem.

Golden Tee '99 GolfV1.00		ID 00000001
DISPLAY TIMERS		
ITS TIME	YY-MM-DD HH:MM:SS	
LOCAL TIME	YY-MM-DD HH:MM:SS	
TOURNAMENT START TIME	YY-MM-DD HH:MM:SS	
TOURNAMENT END TIME	YY-MM-DD HH:MM:SS	
SPECIALS START	YY-MM-DD HH:MM:SS	
SPECIALS END	YY-MM-DD HH:MM:SS	
CALL IN TIME	YY-MM-DD HH:MM:SS	
FIRST TRY TIME	YY-MM-DD HH:MM:SS	
NEXT TRY TIME	YY-MM-DD HH:MM:SS	
CALL IN ATTEMPTS	XX	
GAME ID	00000001	
BOARD SN	00000001	

DISPLAY TIMERS SCREEN

ITS TIME is the current time read by the real time clock on the PCB using Greenwich Mean Time minus 12 hours.

LOCAL TIME is the current time in your time zone.

TOURNAMENT START TIME and **END TIME** show the current settings for the most current tournament.

SPECIALS START and **END** refers to any special contests during a tournament such as a Hole-in-One contest over a weekend.

CALL IN TIME is the approximate time that your machine calls in to the **ITS**.

FIRST TIME TRY and **NEXT TIME TRY** show when your game began calling the **ITS** and when it will try again. These times will only show if a first attempt at a call was unsuccessful.

CALL IN ATTEMPTS shows the number of unsuccessful phone calls, if any.

GAME ID NUMBER should match the **ITS** number on your game cabinet. If this number does not match your game cabinet, call Incredible Technologies service department immediately, as this problem will hinder tournament play.

PCB SERIAL NUMBER should match the **AAMA** sticker on your PCB. If this number does not match your PCB, call Incredible Technologies service department immediately, as an incorrect number will hinder tournament play.

NOTE:

Your programmed Game ID Number and AAMA PCB serial number appear on this screen. Use this information to verify that they are the same as the stickers on your cabinet and PCB. If these numbers do not match, you will not receive correct tournament data. Contact Incredible Technologies immediately.

Leaderboard Menu

The factory default for Golden Tee '99 displays pre-set initials and scores on the Leaderboard, which allows for a sense of competition and improvement to the player. If you are going to run your own league or tournaments, you may wish to delete these placeholders so only real players are displayed on the Leaderboard.

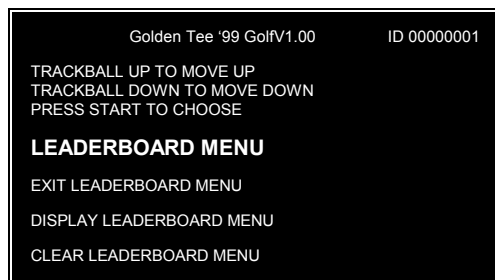

LEADERBOARD MENU

To view the various course Leaderboards, highlight **DISPLAY LEADER BOARD MENU**.

To clear all of the scores and names in the various course leader boards, select **CLEAR LEADER MENU**.

Display Leaderboard Menu



DISPLAY LEADERBOARD MENU

Select the course you wish to look at, and press the **START** button. The screen will stay on until you press **START** again to exit. You can use this information to determine your tournament or league winners. Great shot points have been included on this screen for use as tie breakers.

NOTE:

Great Shot Points are not displayed during the game, so players may not be aware of their Great Shot Point total.

Clear Leaderboard Menu



CLEAR LEADERBOARD MENU

When selecting an in-house tournament, you should clear all of the names and scores from the course you wish to play on. Highlight the course Leaderboard and press START. All of the initials and scores will be cleared, and the Leaderboard will be empty. Players who complete an 18 hole course on the cleared course will have their statistics saved on the Leaderboard until it is cleared again.

System Tests Menu

Golden Tee '99 Golf has been inspected and tested at the factory, and most likely the game will be in perfect working order when you plug it in. If you are experiencing any problems with the game, the *System Tests Menu* is a good place to start when tracking down the problem. The *System Tests MENU* can be found in the *OPERATOR MODE MENU* by pressing the test switch located just inside the coin door of the cabinet, or set DIP Switch 1 on the Main PCB to the OFF position.

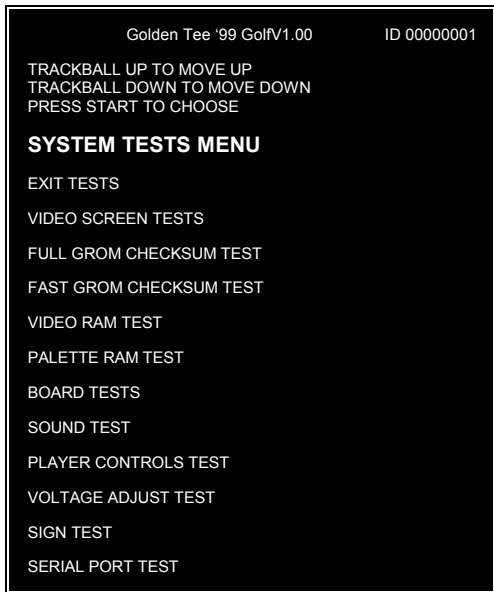

SYSTEM TESTS MENU

Video Screen Test

You can test your monitor and adjust colors by choosing *VIDEO SCREEN TESTS* and pressing the START button.

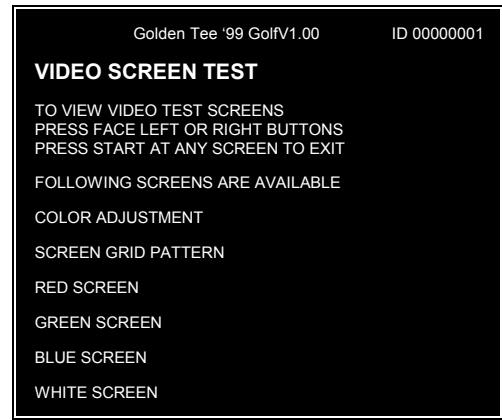

VIDEO SCREEN TEST SCREEN

When the FACE LEFT or FACE RIGHT buttons are pressed, the screen changes to display a grid of colored rectangles. Use these colors as a guide and adjust your monitor so they look as good as possible. This test can be exited at any time by pressing the START button.

Full GROM Checksum Test

Choose *Full GROM Checksum Test* from the *System Test Menu* to test the Graphics chips on the PCB. This test performs a complete test of the Graphics ROM's. While the test is in progress the following message is displayed:



FULL GROM CHECKSUM TEST SCREEN
(Test In Progress)

When the test is completed the GROM Test Screen is displayed.

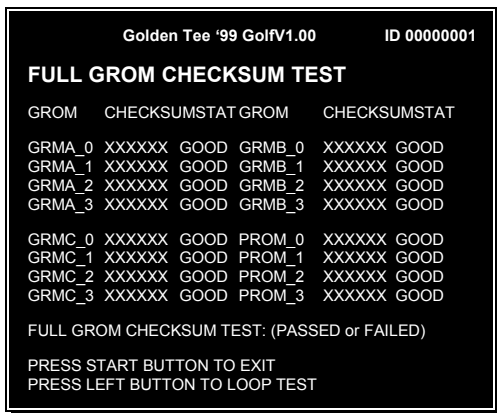

FULL GROM CHECKSUM TEST SCREEN
(Test Completed)

- If all checksums are shown in white, the test passed and your game is in good working order.
- If any checksums are bad, they will be displayed in red text on this screen. This means that the GROM is defective and needs to be replaced. Call your distributor or the Incredible Technologies, Inc. Service Department for further help.
- To loop this test, press FACE LEFT button.
- To exit this test, press the START button.

Fast GROM Checksum Test

Choose *FAST GROM CHECKSUM TEST* from the *SYSTEM TEST MENU* to test the Graphics chips on the PCB. This test performs a partial test of the Graphics ROM's. While the test is in progress the following message is displayed:



FAST GROM CHECKSUM TEST SCREEN
(Test In Progress)

When the test is completed the GROM Test Screen is displayed.

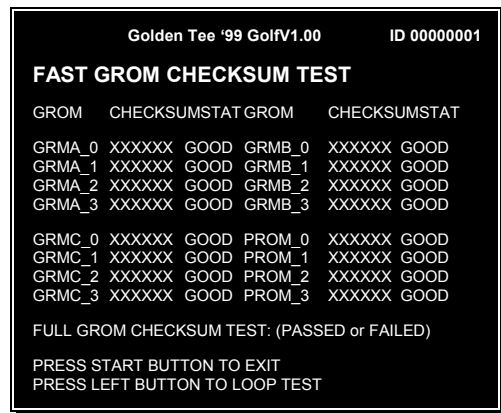

FAST GROM CHECKSUM TEST SCREEN
(Test Completed)

- If all checksums are shown in white, the test passed and your game is in good working order.
- If any checksums are bad, they will be displayed in red text on this screen. This means that the GROM is defective and needs to be replaced. Call your distributor or the Incredible Technologies, Inc. Service Department for further help.
- To loop this test, press FACE LEFT button.
- To exit this test, press the START button.

Video RAM Test

This test performs a complete test of the Graphics video RAM. The video RAM is tested in two pages. The following message will be displayed as each page is tested.

```

RUNNING VIDEO PLANE A/B. PAGE 0
    
```

When the test is completed the results will be displayed as follows.

```

Golden Tee '99 GolfV1.00      ID 00000001
VIDEO RAM TEST
VIDEO PLANE A PAGE 0 STATUS      = 0000
VIDEO PLANE A PAGE 1 STATUS      = 0000
VIDEO PLANE B PAGE 0 STATUS      = 0000
VIDEO PLANE B PAGE 1 STATUS      = 0000
U32 GOOD  U35 GOOD  U30 GOOD  U31 GOOD
VIDEO RAM TEST [PASSED or FAILED]
PRESS START BUTTON TO EXIT
PRESS LEFT BUTTON TO LOOP TEST
    
```

VIDEO RAM TEST SCREEN

- If the game passes this test, zeros will be displayed in white along with a VIDEO RAM TEST PASSED message.
- If the test fails, a non-zero status and VIDEO RAM TEST FAILED message will be displayed in red. Call your distributor or the Incredible Technologies, Inc. Service Department for further help.
- To loop this test, press the FACE LEFT button.
- To exit this test, press the START button.

Palette RAM Test

```

Golden Tee '99 GolfV1.00      ID 00000001
PALETTE RAM TEST
PALETTE TEST STATUS= 0000
RED 00000000  GREEN 00000000  BLUE 00000000
00000000  00000000  00000000  00000000
00000000  00000000  00000000  00000000
00000000  00000000  00000000  00000000
00000000  00000000  00000000  00000000
PALETTE RAM TEST (PASSED or FAILED)
PRESS START BUTTON TO EXIT
PRESS LEFT BUTTON TO LOOP TEST
    
```

PALETTE RAM TEST SCREEN

Board Test

This test will perform all of the system's tests at one time.

```

PROGRAM MEMORY U45-U48 (GOOD or BAD)
PALETTE RAM TEST
RED GOOD  GREEN GOOD  BLUE GOOD
PALETTE RAM TEST (PASSED or FAILED)
VIDEO RAM TEST
U32 GOOD  U35 GOOD  U30 GOOD  U31 GOOD
VIDEO RAM TEST [PASSED or FAILED]
GROM TEST
GROM  CHECKSUMSTAT GROM  CHECKSUMSTAT
GRMA_0 XXXXXX GOOD GRMB_0 XXXXXX GOOD
GRMA_1 XXXXXX GOOD GRMB_1 XXXXXX GOOD
GRMA_2 XXXXXX GOOD GRMB_2 XXXXXX GOOD
GRMA_3 XXXXXX GOOD GRMB_3 XXXXXX GOOD
GRMC_0 XXXXXX GOOD PROM0 XXXXXX GOOD
GRMC_1 XXXXXX GOOD PROM1 XXXXXX GOOD
GRMC_2 XXXXXX GOOD PROM2 XXXXXX GOOD
GRMC_3 XXXXXX GOOD PROM3 XXXXXX GOOD
FAST GROM CHECKSUM TEST: (PASSED or FAILED)
!!! BOARD TEST (PASSED or FAILED) !!!
PRESS START BUTTON TO EXIT
PRESS LEFT BUTTON TO LOOP TEST
    
```

BOARD TESTS SCREEN

Sound Test

Choose **SOUND TEST** from the *System Test Menu* to test the sounds and speakers in the game. The sound section also controls the coin meter, and you can test it from this section as well.

```

Golden Tee '99 GolfV1.00      ID 00000001
TRACKBALL UP TO MOVE UP
TRACKBALL DOWN TO MOVE DOWN
PRESS START TO CHOOSE
SOUND TESTS
EXIT SOUND TESTS
COIN METER TEST
TEST ALL SOUND ROMS
SROM0 - BROKEN GLASS
SROM1 - FABULOUS SHOT !
HOLE IN ONE EVENT
MUSIC
    
```

SOUND TESTS SCREEN

To test the coin meter, choose **COIN METER TEST** from this menu. If everything is working properly, the meter should increment each time the START button is pressed while this line is highlighted.

Control Panel Test

When *CONTROL PANEL TEST* is selected, the screen will display a diagram of a typical GOLDEN TEE '99 GOLF control panel. The controls are highlighted on the diagram when the controls are active. Test all of the controls, including test and service switches. Press FACE LEFT and FACE RIGHT together to exit this test.

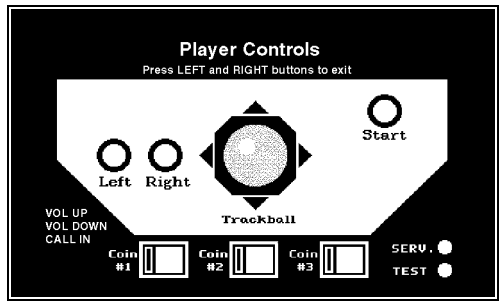

CONTROL PANEL TEST SCREEN

Voltage Adjust Test

Use this screen to adjust the voltage to the PCB. It is important that the voltage be set correctly to avoid reset games or lost video sync.



VOLTAGE ADJUST TEST SCREEN

CURRENT VOLTAGE shows the current status of your voltage. If the voltage is low or high, you may experience some game problems. Adjust your voltage to read 5.2 volts across an IC on the PCB. Exit this screen and re-enter to update your voltage history.

Sign Test

(Tournament Version Only)

This test checks the integrity of the connection from the PCB to the LED sign. Press the LEFT or RIGHT button to activate the sign test. The LED sign will display the code version number, followed by a string of letters and numbers, then a solid bar will scroll across the display.



SIGN TEST SCREEN

Use this test to visually check for non-functioning LED segments.

The video screen will display the communication status. If the status is bad, contact your distributor or the IT service department.

Serial Port Test

(Tournament Version Only)

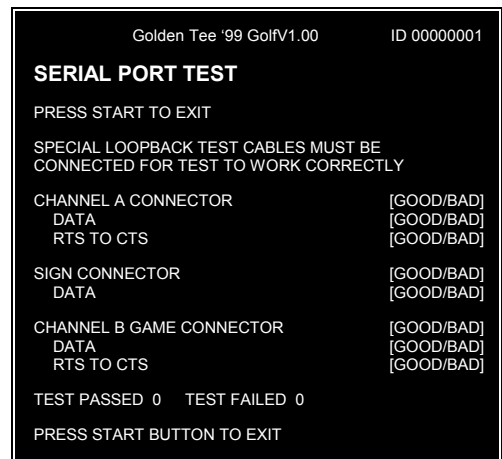

SERIAL PORT TEST SCREEN

NOTE:

Special cables are needed for this test.
(FACTORY USE ONLY).

APPENDIX A

General Troubleshooting

Phone Line Connection Problems (Tournament Version Only)

Symptom	Probable Cause	Solution
Your game is unable to make an initial call to ITS.	Improper phone connection.	<p>Double check all of the cable connections to make sure they are placed and connected properly.</p> <p>Be sure the cables are plugged all the way into their connectors. A click should be heard when a proper connection is made.</p> <p>Make sure the modem is switched ON and its power supply is connected.</p> <p>Enter Test Mode and go to the Tournament Menu. Under Tournament Operator Adjustables, set FORCE TOURNAMENT UPLOAD to YES. Exit Test Mode and try again.</p>
	Modem in lost state.	Turn the game OFF then ON again.
During setup, the text message on the screen says MODEM DIALING and quickly changes to MODEM HANGING UP.	No dial tone.	<p>Check for a dial tone by plugging in a regular telephone into the extra jack on the modem. A dial tone should also be heard from the phone.</p> <p>Double check all of the cable connections.</p> <p>Be sure the game is connected to a direct outside line. ITS will not work if connected through certain phone systems. A fax or credit card line may be used.</p> <p>Make sure the modem is switched ON and its power supply is connected.</p> <p>Set outside line access number, if needed (Tournament Operator Adjustables on page 21)</p>
	Wrong setting in the Tournament Operator Adjustables.	Be sure all the settings in the Tournament Operator Adjustables are correct. Refer to Tournament Operator Adjustables on page 21 for correct tournament settings.

Phone Line Connection Problems (Tournament Version Only)

Symptom	Probable Cause	Solution
Modem connects but does not transfer data.	Bad modem or ID number.	<p>Enter Test Mode and verify the ID number at the top of the screen. If the ID number is not valid, call Incredible Technologies Service Department.</p> <p>Be sure the game is connected to a direct outside line. ITS will not work if connected through certain phone systems. A fax or credit card line may be used.</p>
	Line is busy.	<p>A normally good call is sometimes cut off or interrupted by a busy signal or a noisy line. Wait and the game will try to call again automatically; or go into Test Mode and force a phone call from the Tournament Operator Adjustables menu.</p> <p>Turn the game OFF then ON again.</p>
Modem transfers data but the screen reads CALL IN UNSUCCESSFUL.	Improper connection.	<p>Be sure the game is connected to a direct outside line. ITS will not work if connected through certain phone systems. A fax or credit card line may be used.</p> <p>If the line is being shared, the other phone, fax or credit card machine may be trying to make a call. Wait a few minutes and try again.</p> <p>A loose connection or bad wire may be the cause. Make sure all connections are securely in place.</p>
	Modem in lost state.	<p>Turn the game OFF then ON again.</p>

VIDEO PROBLEMS

Symptom	Probable Cause	Solution
No picture	Check Dip switches.	SW1-Dip switches, 1 thru 4 must be "ON". SW2-Dip switches 1 and 2 must be 'ON', and 3 and 4 must be 'OFF'
	Bad connection.	Make sure there are good connections from the board's video outputs to the monitor's video inputs.
	Monitor.	Make sure the monitor is operating correctly. (Check it with another compatible logic board.)
	JAMMA Harness connected improperly.	Identify Pin 1 on the JAMMA connector and on the PCB. If installed incorrectly, damage to the PCB may have occurred.
Scrambled Picture	Missing sync connection or misadjusted monitor.	Check the sync connection - Adjust monitor
Missing colors or washed out color	Bad video connections.	Check the video red, green, and blue connections.
Bright, blurry, or rolling picture	Misadjusted monitor.	Adjust the monitor, not the board. (Refer to your monitor manual.)
Picture too large, too small, or off center	Misadjusted monitor.	Adjust the monitor, not the board. (Refer to your monitor manual.)
Video image is flipped	Misadjusted monitor.	Reverse the monitor's convergence wires or flip the monitor 180°. (Refer to your monitor manual.)
Bad images in picture	Bad GROM.	Do GROM test. Check IC pins to make sure none are bent over.
Diagonal white lines	GND problem.	Earth and Logic GND's should be connected at the power supply.

SOUND PROBLEMS

Symptom	Probable Cause	Solution
No sound	+12 vdc power supply is bad	Try another +12 vdc power supply.
	Bad connection to the board.	Check for +12 vdc power on the board.
		Check for +5 vdc power on the board.
		Check the volume setting in the OPERATORS ADJUSTABLE section of the Operator Mode.
	JAMMA Harness connected improperly	Check the speaker connection.
Miscellaneous	Identify Pin 1 on the JAMMA connector and on the PCB. If installed incorrectly, damage to the PCB may have occurred.	

CONTROL PROBLEMS

Symptom	Probable Cause	Solution
Buttons do not work or are partly inoperable. Or the selections keep scrolling on Operator Mode menus.	Switches not properly connected.	Make sure that the common post of the switch is connected to ground.
		Make sure each individual switch is working by doing the Control Panel Test found in the SYSTEM TESTS section.
	JAMMA Harness connected improperly.	Make sure that the signal wire for that particular switch is connected to the normally open post of the switch.
Coin counter not working	Miscellaneous.	Identify Pin 1 on the JAMMA connector and on the PCB. If installed incorrectly, damage to the PCB may have occurred.
		Make sure that the signal wire has a connection from the switch to the board.
		Make sure +12v is hooked up to the counter.
Trackball mounted correctly but is swinging 45° out of line	SW1-Dip switch 3, found near the JAMMA, is not "ON"	The signal wire is not connected to coin counter. (Check continuity).
		Verify that the counter is good.
		Make sure SW1-Dip switch 3 is "ON".
In a two or more player game, controls only work for players 1 and 3	SW1-Dip switch 2, found near the JAMMA, is in the "OFF" position.	SW1-Dip switch 2 must be in the "ON" position for cabinets with one set of player controls.
Trackball does not work	No +5 voltage.	Bad inductor(L7) or bad connection to trackball.

POWER-UP PROBLEMS

Symptom	Probable Cause	Solution
Bo reaction when game is turned ON	Voltage too high.	Power supply is too high. Power should be between +5v & 5.2v. (Measured on the circuit board).
		Cabinet is not connected to earth ground. (All metal should be connected to the earth ground).
		Short between power and ground. Check for foreign material.
		Disconnect the harness and measure the resistance between power and ground. It should read around 600 ohms. (0 ohms is a dead short).
		Make sure the harness is not shorting to anything, such as bare or frayed wires shorting out each other or hitting bare metal.
Screen flashes repeatedly	No power from the power supply.	Replace power supply.
	Power supply needs adjustment.	Power supply too low. (Should ideally be between +5v & +5.2v). (Measured on the circuit board).
	Short on the board.	Check for loose or foreign material on the board.
	JAMMA Harness connected improperly.	Identify Pin 1 on the JAMMA connector and on the PCB. If installed incorrectly, damage to the PCB may have occurred.
Screen flashes repeatedly	Open on socketed IC's	Check for bent pins on socketed parts. Make sure that all IC's are seated in their sockets properly.
	+5v setting too low.	Check voltage. (Measured on the circuit board).
	SW2-Dip switches near the green LED may not be set correctly.	Make sure SW2-Dip switch #1 and # 2 are "ON", and #3 and #4 are "OFF".

LED SIGN Problems (Tournament Version Only)

Symptom	Probable Cause	Solution
The LED message does not get updated correctly	Improper connection.	Check that the sign cable is plugged into the jack labeled SIGN on the PCB, and the other end is plugged into the LED sign.
		Check that the power jack is connected properly to the sign and that the sign is getting power.
The LED sign is not on	No power.	Make sure there is +12 volts going to the sign.
		Long screw is used in the top instead of the bottom.
	Bad cable.	Verify that the sign cable is good, by trying a known good cable or by testing the continuity of the cable.

MISCELLANEOUS PROBLEMS

Symptom	Probable Cause	Solution
Green LED not blinking	Program not running.	Make sure all socketed IC's are seated correctly. Look for bent pins.
	Bad connections.	Make sure you have continuity from PCB to power supply.
	Loose pin on ASIC (U1)	Call Incredible Technologies, Inc.
Operator adjustables keep changing	Low battery voltage	Battery should be 2 to 3 volts.
	Bad static RAM (U50)	Replace.
Sounds Bad	Miscellaneous	Check the speaker connections.
Game comes up in Test Mode	Dip Switch 1 is "OFF"	Make sure SW1-Dip Switch 1, near the JAMMA, is in the "ON" position.
Trackball mounted correctly but is swinging 45° out of line	SW1-Dip switches are not all "ON"	Make sure the SW1-Dip Switches are all "ON"

APPENDIX B

JAMMA Harness Connection and Cabinet Schematic

JAMMA Harness Connection

WIRE COLOR	SOLDER SIDE			PARTS SIDE	WIRE COLOR
Black	GND	A	1	GND	Black
Black	GND	B	2	GND	Black
Red	+5 vdc	C	3	+5 vdc	Red
Red	+5 vdc	D	4	+5 vdc	Red
		E	5		
Orange	+12 vdc	F	6	+12 vdc	Orange
KEY		H	7	KEY	
		J	8	Coin Counter	Red-Green
		K	9		
Yellow-Green	Left Speaker (-)	L	10	Left Speaker (+)	Yellow-Red
		M	11		
Green-Black	Video Green	N	12	Video Red	Red-Black
White	Video Sync	P	13	Video Blue	Blue-Black
Orange-Black	Service	R	14	Video GND	White-Black
		S	15	Test	Blue
Green-Blue	Coin2	T	16	Coin1	Red-White
Red-Yellow	Start 2	U	17	Start 1	Red-White
		V	18		
		W	19		
		X	20		
		Y	21		
Brown-Yellow	Player 2 - Face Left	Z	22	Player 1 - Face Left	Brown-White
White-Yellow	Player 2 - Face Right	a	23	Player 1 - Face Right	Yellow-White
Orange-Yellow	Volume Down	b	24	Volume Up	Orange-White
		c	25	Coin 3	Gray-White
		d	26		
Black	GND	e	27	GND	Black
Black	GND	f	28	GND	Black

Trackball Harness Connection

Memory Board Connector	Trackball Connector
PIN WIRE #6 - Black	PIN WIRE #1 - Black
PIN WIRE #1 - Red	PIN WIRE #2 - Red
PIN WIRE #2 - Yellow	PIN WIRE #3 - Yellow
PIN WIRE #3 - Green	PIN WIRE #4 - Green
PIN WIRE #5 - Blue	PIN WIRE #5 - Blue
PIN WIRE #4 - Purple	PIN WIRE #6 - Purple

NOTE: Remember to connect the trackball cable to JP7 of the Memory Board. (Labeled as Player 1)

Cabinet Schematic

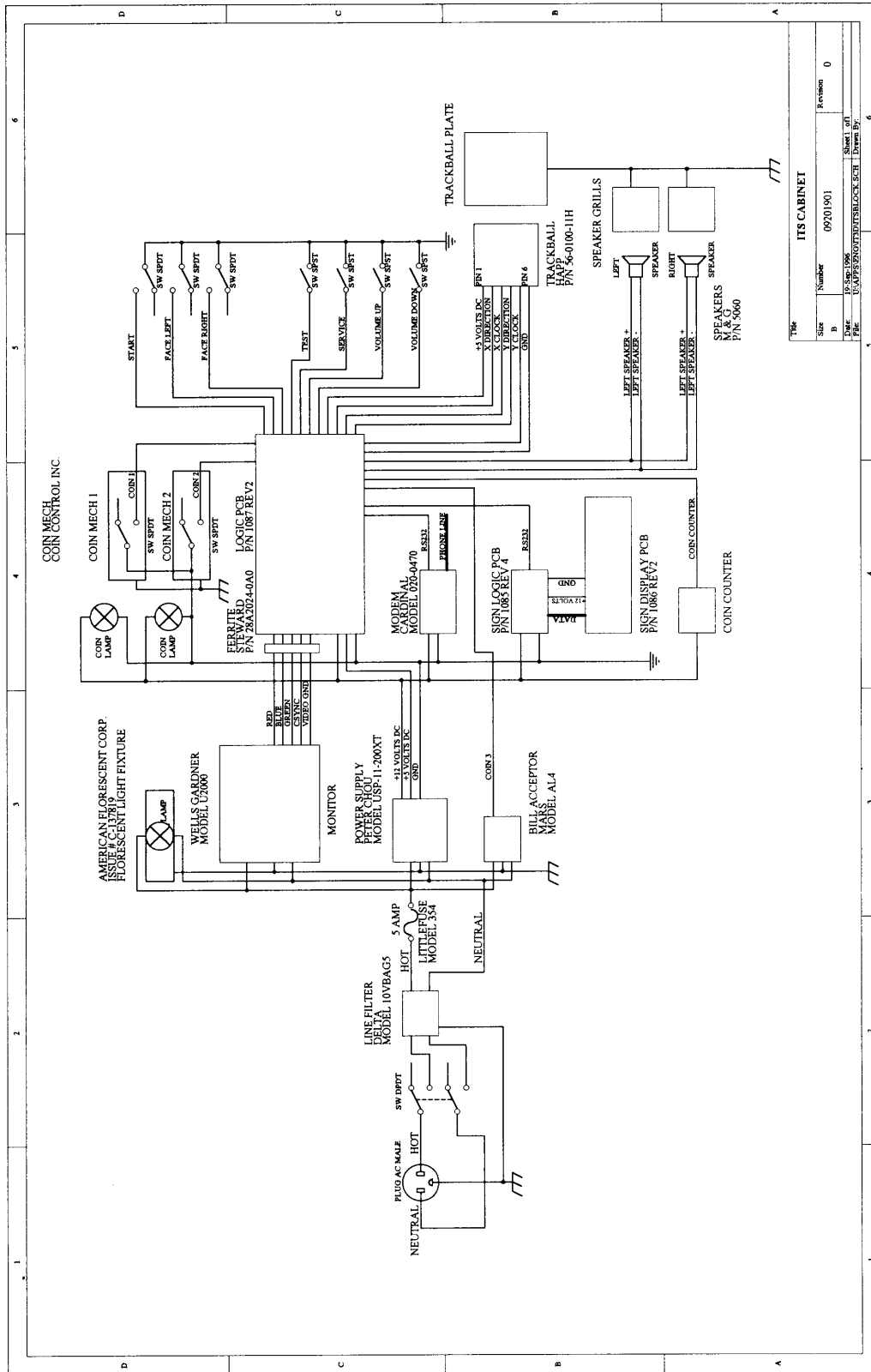

ITS CABINET				
Size	Number	09201901	Revision	0
Date	16 Sep 1996			Sheet of
File	U:\APP\SPG\ITM\BLOCK\CH - Drawn By			Drawn By

APPENDIX C

ITS Tournament Overview

The **ITS**, or International Tournament System™, is a networked system of game machines that are hooked up to a central computer via normal telephone lines. Each dedicated tournament game contains special tournament software and communications hardware that offers players a choice of regular or tournament play. Tournament play allows players from all over the U.S. to compete for prizes. Various skill-based tournaments will be held throughout the year, offering challenges and prizes to players across the country.

The **ITS** was designed to be as hands-free as possible for the operator and location. Each machine has special communications hardware that easily hooks up to a normal telephone jack. Each game machine is programmed to make a short, toll-free phone call during off hours. The toll-free number that the game dials costs nothing to the operator or location. The tournament machines call the **ITS** central computer and download statistics from that day's tournament play. During the same call, the central computer sends the new tournament leaders, previously gathered from all of the games in the tournament, back to the game machine. Then, throughout the day, the new national and local tournament leaders are viewed on each game monitor during attract sequences.

The **ITS** is capable of supporting over 100,000 tournament machines on-line. The **ITS** will feature a number of national tournaments throughout the year. These tournaments will vary in length from weekly to monthly, with top prize awards ranging from one thousand to potentially one-hundred thousand dollars or more. Before each tournament begins, a message is sent to the LED sign attached to each cabinet, announcing the start dates and prize structure of the upcoming tournament. At the specified date, the tournament automatically begins on all of the valid tournament games.

The entry fee to join the tournament is about twice the cost as regular play, and is entered into the game by the player each time he/she plays. About half of this tournament income is shared by the operator and location. The rest of the tournament fee is sent to the **ITS** for national, regional and local prize funds, as well as administrative expenses. The **ITS** receives a portion of tournament plays only. Any earnings collected from regular and practice play is not considered tournament income. This income is split between the operator and location as they see fit.

Connecting to the **ITS** has been made as simple and complete as possible. The game hooks up to a normal telephone jack using regular telephone wire. Once plugged in, an automatic setup procedure logs the game machine as an active tournament terminal. A simple form must also be filled out, detailing some specific information for that machine, such as game ID number, location name, preferred time for phoning into the central computer, and pertinent billing information.

The **ITS** was designed with the operator in mind. Each **ITS**-compatible game can act just like a regular video game on his route. The games can be moved to different locations and will play a regular, non-tournament game even when not hooked into the **ITS**. Location change forms and off-line notices are supplied in your operator forms package, to keep your tournament activities up to date.

Game Highlights

- High-earning, successful game.
- Hooks up with a single existing phone line.
- Game machines can be moved from location to location.
- Up to 8 ITS game machines can be linked from modem to modem at a single location and share one phone line.
- Regular play is always available, regardless of tournament status.
- More tournament-compatible games are in development.

Tournament Highlights

- Many tournaments will be held throughout the year.
- Tournaments may vary in length, from one to four weeks.
- Cash prizes will be awarded to national, regional, and local winners.
- Every game machine in a tournament will offer an even playing field.
- Different tournaments can be running at the same time.
- Corporate sponsors are being considered for added prizes and important promotions.

Networking Highlights

- The game machines automatically call the **ITS** central computer each night on a toll free number.
- The toll free number costs nothing to the operator or location.
- New statistics, such as new leaders and scores, are sent to the central computer.
- Important messages are sent periodically to the LED signs that advertise new tournaments and important information.
- Tournament updates, compiled from all of the collected data of the previous day, are sent to each game machine.
- The entire phone call process takes less than a minute.
- If the game fails to connect with the central computer, it will try again until it is successful.

Accounting Highlights

- Tournament billing is routed through an automatic debit account.
- Statements are faxed or mailed before each debit transaction, detailing the tournament billing.
- Debit transactions take place one time per tournament, after each tournament ends.
- Complete tournament audits and collection procedures assure accurate and easy record-keeping.

ITS Game Initialization Form
(Tournament Version Only)

Included with your game is the **ITS** Game Initialization Form. Fill it out completely and fax or mail it to Incredible Technologies. The information you supply goes into the tournament database and is necessary for your game to join the tournament.

IMPORTANT!

Your game will **NOT** be included in the tournament until this form is received by Incredible Technologies.

ITS Debit Account Form
(Tournament Version Only)

Included in your game is an **ITS** Debit Account form. All operators must have and maintain a bank account for automatic payment of the **ITS** portion of tournament play. Please fill out the form completely and send it back to Incredible Technologies, Inc. with a voided blank check or deposit slip from the account. You only have to fill out this form one time, no matter how many **ITS** games you operate. All of your **ITS** games can be billed to a single account.

NOTE:

Your game will **NOT** be included in the tournament until this form is received by Incredible Technologies.

At the end of each tournament, you will be faxed a statement that details the **ITS** portion of the tournament plays on all of your **ITS** machines. Your account will be automatically debited for the full amount about four to seven business days after each tournament ends. If the correct funds are not available, the next tournament will be unavailable on your games. The **ITS** bills for a portion of tournament plays only. Regular play is disregarded by the **ITS**.

APPENDIX D

ITS Tournament Procedures

Official Tournament Rules

Insert coins into an active **ITS** Tournament game and press Start. A selection screen will appear when a tournament is in progress. Select Tournament Play and Insert the appropriate tournament entry fee.

Play the entire Official Tournament Course. If your final score qualifies, the game will ask you to enter your full name and Social Security Number. This information is used for winner verification purposes.

Use your real name and Social Security Number or your score may be invalidated.

Players can enter the Tournament as often as desired. A player's best score will be displayed on the Leaderboard. Profanity, vulgarity, invalid names and invalid Social Security Numbers will be removed from the Leaderboard. Players who allow their score to be entered under another person's social security number will be banned from all **ITS** tournaments.

You must be **18 years or older** to enter a Tournament and claim a prize. Misuse of or tampering with tournament equipment will disqualify the player and/or location from the Tournament.

The Tournament is subject to rules and procedures of the **ITS**, the tournament location, federal and state law. Void where prohibited.

A list of winners will be provided to each tournament location when the Tournament ends.

Winners are solely responsible for claiming their winning prize by calling Incredible Technologies at (847) 870-7027.

Game operators and locations will not pay prizes.

A player can only win one prize per Tournament. Only one National winner per location is allowed for each tournament. Only one Regional winner per location is allowed for each tournament. Only one Local winner per location is allowed for each tournament. Tournament rules are subject to change.. New or altered rules from the **ITS** supersede these posted rules and may be posted on the game LED displays.

Prize winners must sign a written claim form and present a copy of a driver's license or other picture ID containing the winner's social security number.

Malfunctions void all plays and refunds are given at the discretion of each tournament location for paid entry fees only. The **ITS** Review Board shall decide all filed grievance claims. The Board's decisions are final and claims are limited to refund of entry fee only.

Employees of Incredible Technologies, Inc. and manufacturers of games used on the **ITS** system and their immediate families are not eligible. Rules and regulations specific to each Tournament and winner lists from previous tournaments are available by sending a self-addressed, stamped envelope to:

Incredible Technologies, Inc.
ITS Information
1600 Hicks Road
Rolling Meadows, IL 60008-1240
<http://www.itsgames.com>

NOTE:

Tournament Rules are subject to change and will be updated on the LED signs of participating tournament games.

Beginning a Tournament

The following describes what will happen when a tournament begins on your game.

1. **The LED sign displays a new message** 3 to 5 days before the tournament start date. The sign message displays the Tournament name, start and end dates, prize money and tournament rules.
2. **Tournament data is downloaded to each machine** before the tournament begins. Each machine receives the Tournament parameters and start and end dates of the Tournament.
3. **The Tournament is accessible by players** on the start date of the tournament. When a game is started, a special screen gives players a choice to play Regular Play or Tournament Play. This screen is seen only when a tournament is running.
4. **Players with qualifying scores** are asked to enter their full name and social security number at the end of each tournament game. The player's name is then displayed on the various Tournament Leaderboard, shown during the game's attract cycle.
5. **Each night the game machine calls ITS Central** via a toll-free number. During the short call, tournament information is transferred. Transferred data includes National, Regional and Local leaders and Social Security numbers, total number of tournament plays, and any special or instant winners.
6. **ITS Central processes the data received** from all of the tournament machines. After removing duplicate or bogus entries, updated Leaderboards are generated and sent to each machine during the next call. New LED sign messages are also sent, updating the various Leaderboards, prize funds, and other important tournament data. Advertising by corporate sponsors may also appear on the LED sign and game monitor.

Collection Procedure

Although the tournament games have been designed to be as hands free as possible, there is an extra step that must be addressed during the collection process. You will need to separate the **ITS** portion of the game's earnings before you make your location split. The **ITS** only bills for valid tournament plays. All Regular play is ignored by the **ITS**.

1. Collect each **ITS** Machine as usual on your normal route.
2. Press the Test Mode button located inside the coin door. This accesses the game's Test software.
3. From the Main Menu, use the Trackball to highlight **ITS COLLECTION REPORT AS DOLLARS** or **ITS COLLECTION REPORT AS COINS** and press the START button. Both reports will show the same information, one in total coins and one in total US dollars. You can use either report to match your collection preference.
4. Review the entire report. The total dollars or total coins should agree with your collection. Note the number of completed tournament games.
5. Review the **ITS** portion figure. This amount should be separated from your collection **before** splitting with the location. **ITS** coins are calculated from valid tournament games only.
6. After separating the **ITS** coins and writing down the values, it is advised to reset the audits so each collection gives accurate data. Highlight **RESET COLLECTION COUNTS** and press START.
7. When you are finished reviewing the coin reports screen, highlight **EXIT** and press the START button to return to the Main Menu.

8. Once the **ITS** portion is separated, split your collection with your location as usual.
9. Deposit the **ITS** portion of your collection into your **ITS** Automatic Debit Account regularly to guarantee sufficient funds and continue Tournament service.

Ending a Tournament

The following describes what happens at the end of a tournament.

1. **The Tournament ends on the advertised end date.** Each tournament game is programmed to disable Tournament play at this time. Games in progress are allowed to continue until completed.
2. **The disabled game machine will no longer allow Tournament play.** Players will no longer have a selection screen for Regular or Tournament play. Regular play is completely unaffected by the end of the tournament and the game will play as usual.
3. **Final Tournament data is downloaded from each machine** during the regularly scheduled call-in time. A new LED message is sent to each machine at this time, announcing the end of the Tournament.
4. **A list of Tournament winners is compiled** after all of the games have called the **ITS** with final data. It may take three to four days for all of the games to make their final calls. When all of the games have reported in, the final standings are transferred to each machine.
5. **Final Leaderboard and new LED messages continue to appear** on each game machine after the Tournament ends, to allow players to view the final standings.
6. **Winners Lists are made available to locations for display.** The signs include instructions to the winners on how to claim their prizes. Incredible Technologies is responsible for distribution of prizes to verified winners. Operators are responsible for posting the Winners Lists at their locations.
7. **The game machines continue to call the ITS each night, even when no tournament is running.** Machines remain on-line in order to monitor for potential problems, as well as be ready to accept new LED sign messages and starting data for the next tournament.
8. **A statement is faxed to the operator at the end of the tournament** that details the tournament activity on each of his machines. The total number of tournament plays and the dollar value of the **ITS** portion of the tournament plays appears on the statement, along with the date that the **ITS** funds will be transferred from the operator's automatic debit account. Operators are usually given 4 to 7 business days to make their **ITS** funds available before the funds are electronically transferred.

Prize Claim Procedure

The **ITS** will send you an official Winners List Poster for each tournament location at the end of a Tournament. Distributors and Operators are **required** to distribute the Winners Lists to their locations.

Operators should encourage locations to post the Winners List near the game machine for at least one month or longer after the end of the Tournament.

Tournament winners must call Incredible Technologies, Inc. at (847) 870-7027 to claim their prizes. Winners will be asked for name, social security number and winning location, along with their address and phone number.

The **ITS** will mail Tournament winners a Prize Release form that must be signed and returned with a photocopy of a valid ID that contains the winners address and social security number, for proper verification.

The **ITS** will mail the winner their prize after a designated verification period, if no duplicate or false claims have arisen. All tournament prize winnings will be reported to the IRS as required. Winners of prizes totaling \$600 or more will receive a 1099 tax form at year end.

Tournament winners are solely responsible for claiming their prize and verifying their scores.

Incredible Technologies, Inc. is solely responsible for payments of prizes to valid tournament winners. Distributors, operators and locations are not responsible for payment of prizes to winners.

If discrepancies or duplicate claims arise, Tournament winners may be subject to validation tests and other forms of verification by the **ITS** Review Board.

Tournament winners ***must be 18 years or older*** to enter a Tournament and claim a prize.

Misuse of or tampering with tournament equipment will disqualify the player and/or location from the Tournament.

The Tournament is subject to rules and procedures of the **ITS**, the tournament location, federal and state law. Void where prohibited.

Tournament Icons

Your game contains a simple icon feature that will assist you and your location in monitoring the status of your phone line connections. During the attract sequence of the game, which is displayed when no one is playing, a number of small icons are displayed. The displayed icons will help you determine at a glance the working status of the tournament and your game cabinet.



Tournament Status OK

This icon means that your game is running correctly and your line connections are good. Your game will make one toll-free phone call each day, even if there is no tournament running.



Tournament Disabled.

This icon is displayed when the tournament has been automatically shut off on the game. The tournament is disabled if a game was unsuccessful in connecting to the ITS over a 24 hour period. The tournament also may be disabled from the ITS if tournament forms have not been sent, tournament fees have not been paid, or game tampering is detected.

Often, the game can be restored to the tournament in progress by forcing a successful phone call using the tournament menu in test mode. If the tournament has been reset for other reasons, call your distributor.



Attempting to make a call to ITS

This icon will appear if an attempt to make a scheduled call was unsuccessful. When an attempted call is unsuccessful, the game will try again automatically. The number of attempts is displayed next to the icon at the bottom of the screen, during the attract mode.

The game will try to call frequently for the first couple of hours, and occasionally after that. After about twenty-two hours, the game will frequently try to call again. If the game has not connected to the ITS within this 24 hour period, the tournament is automatically disabled from the tournament. At this point, the only way to enable the tournament is to force a successful phone call using the tournament menu in test mode, or to fix whatever problem is preventing a successful call.



No Dialtone detected, or modem problem.

This icon is displayed if the game detects a problem with the modem, or if the game cannot find a dial tone. This is a good warning to the location manager that the phone lines may be disconnected and should be checked. It may also indicate a faulty modem, which should be serviced immediately.

To verify a dial tone, plug a normal telephone into the empty jack on the modem. A dial tone should be heard. If not, there is a problem with the phone line, such as a broken phone line or disconnection. Check all of your phone connections and be sure they are correct and secure.

This icon will also appear if the phone line is in use when the game attempts to make a call. If this situation occurs, the game will attempt to make the call at a later time.

APPENDIX E

Frequently Asked Questions About The ITS

How do I make the game call into ITS at any time?

Go into the test software and choose Tournament Menu with the trackball and START button. Next select Tournament Operator Adjustables. The top line is Force Tournament Upload. Change that to Yes by rolling the trackball to the right. Exit the test software by repeatedly pressing the START button. The game will then make a call to ITS. If the call fails, enter the test software and exit immediately and the game will attempt to call again.

Does the game call the ITS, or does ITS call the game?

The game is programmed to call into ITS on a toll free line one time each day.

When does the game call ITS and how many times?

The game calls once during the night at a predetermined time selected by ITS. The default calling time is between 2 and 4 in the morning.

What if the game is turned off and misses its scheduled time to call ITS?

As soon as the game is turned on it will attempt to complete a call to ITS.

Can the operator select a specific time for the game to call ITS?

Yes, ITS can give the cabinet a specific time within the hour. Example: between 7am and 8am. Specify this on the Game Initialization Form.

How will I know if a successful call has been made?

When the game is attempting a call, the screen will display an ITS CALL screen. The text near the bottom of the screen will show the status of the phone call. A typical successful call will display the following status messages in this order: Modem Found, Modem Dialing, Modem Connected, Connected to ITS, Data Transfer Successful.

What are the symbols at the bottom of the screen for?

Your game will display a number of icons at the bottom of the screen, to help you know the status of your game at a glance. There are four different icons that are displayed: The gold ITS logo means that you are connected to the ITS system and everything is OK.

The blue telephone icon means that your game has tried to make a call, but was unsuccessful, perhaps from a busy signal or interrupted call. A number will appear next to the icon, showing how many call attempts have been attempted. If this number is big, you probably have a problem with your phone line or modem and it should be checked out.

The telephone with the red X through it means that your modem is not receiving a dial tone. This may be caused by the phone cord being disconnected, loss of power to the modem, etc. When this icon is showing, it means that your game is not calling the ITS and will not receive or transmit tournament data.

The ITS logo with a red X through it means that your game has been disabled and removed from the tournament. This happens when your game has not been able to call in for more than 24 hours. Often, this can be remedied by forcing a call or checking your phone connections. This icon may also appear if you have not sent in your paperwork. Your game will not receive tournament information until your paperwork has been processed through the ITS.

When I attempt to make a call to ITS, the game comes back and says no dial tone found. What do I do?

Plug a normal telephone into the extra phone jack on the modem. A dial tone must be heard on the phone. If no dial tone is heard check your phone line connections. If a dial tone is heard, try dialing a phone number to make sure you can call out.

Can I use this game on a rotary phone system?

The game is factory set to call out on a tone system, but you can set your game to use rotary or pulse dialing. Enter the test software and select Tournament Menu with the trackball and START button. Next select Tournament Operator Adjustables. Highlight the Rotary Dial to yes using the trackball and START button.

I have a dial tone but I never get a successful call into ITS. What do I check first?

Make sure the settings in the Tournament Operator Adjustables menu are correct (Refer to page 21 of the manual). Ask yourself some questions. Is this location on a rotary phone system? Is the phone line on a computer phone system? (The tournament may not work on all phone systems.) Do I have to dial something to reach an outside line?

When I force a call into ITS it says modem connected but the game comes back and says ITS call unsuccessful. Why?

The game may be on a noisy phone line. This can be caused by old phone lines, too many devices on the line, or bad lines coming from the phone company. A direct connection to the box coming into the building or a new separate phone line added to the building is a way to rectify this problem.

I made a successful call so why can't I enter the tournament?

The paper work for the game must be sent or faxed to the ITS for processing. Without the paperwork, your game will not receive tournament data and LED messages. Also, a Tournament must be in progress. A game can be added to the tournament up to 1 week after the official start of a new tournament so be sure to get your paperwork in early.

If my board fails can I just go to the distributor and get a new board?

NO. Your game PCB has an ID number programmed into it to match your game cabinet. The board ID number that is in the software must match the cabinet ID number, in order for you to receive tournament data. Contact your distributor for all advance replacements, which must be properly initialized by Incredible Technologies.

If I call the distributor or ITS for service, what information should I have ready in case the service technician needs it?

The Game ID Number is how your game's status is tracked. The ID number of the cabinet must match the ID number in the software. You can verify this by going into the test software. The Game ID Number is displayed at the top of every screen in the test software. It is also displayed in the Tournament Menu, at the bottom of the Display Timers screen. The number must be 8 digits long, leading with zeros.

Why does the overhead sign have a different name than my location name?

When you send in your paperwork, a sign message is generated for your game. This sign message will display the name of the location. If the location name on the LED display is wrong, you should first check that you sent in the correct Game ID Number. The Game ID Number is located on the back of the cabinet and in the test software. Verify that those numbers are the same. Go into the test software to verify the ID number there. It is displayed at the top of the screen and must be 8 digits long leading with zeros. If your ID Numbers are correct, call or fax ITS and a corrected message will be made.

My overhead sign has some kind of test version on it all the time. Why is it doing that and how do I get a regular message on it?

The ITS pre-loads an introductory message at the factory and should appear when the game is turned on. Sometimes, the sign may lose this message and default to the sign test. To get your correct sign message back, force a phone call to the ITS. The new message will be loaded during this successful call. Turn the game off and back on again to make sure the message stays in memory. Run the sign test in the test software to make sure the main board is communicating to the sign.

How do I know when there is a tournament?

Upcoming tournament dates and prizes will be announced on the game's LED sign a week in advance. Your distributor will most likely supply this information to you on your first tournament. Announcements of subsequent tournaments will be included with your billing statements at the end of each tournament.

How do the players know when there is a tournament?

Special tournament messages are periodically downloaded to the game's LED message display. These messages announce new tournaments and prizes. The individual Local prize is also announced. The message board begins announcing a new tournament about 4 days before the tournament begins.

How often do Tournaments run?

Tournaments are held about once a month. They usually last about 2 1/2 weeks, with about a week and a half between.

Why don't you run tournaments continually, back-to-back?

Time between tournaments is useful for many reasons. It gives the players a feeling of conclusion, and a sense of anticipation for the next tournament. It gives operators a chance to hook up new games or move their existing games to a new location. It gives the ITS time to generate and mail winners posters to operators.

How does a player enter the tournament?

A player enters any amount of money into the tournament cabinet. If a tournament is active, a special selection screen appears. This selection screen gives the player a choice to play a regular game of golf at your normal coin settings, or enter the special tournament course for a specified fee. If the player chooses to enter the tournament, the game asks for the correct number of coins to be added.

Can I adjust the skill level on the tournament?

The skill level and other parameters such as wind speed and pin placement are controlled and set by the ITS. These settings are the same on every machine. You can change the skill level on the regular games without affecting tournament play.

How do I know how much money to send to the ITS?

When collecting your ITS machines, it is important to separate the ITS money from your collection before making your split, so you don't overpay your locations. During your routine collection, use the ITS Collection Report in the test software to determine how much money to set aside for the ITS. You can use either the Collection Report as Dollars or the Collection Report as Coins. It is strongly advised that you reset this report to zero after your collection, so each time you collect, this report will reflect what is in the cash box.

If I reset my reports after each collection, how can I verify my totals at the end of a tournament?

A second set of tournament statistics are stored in the test software, in the Tournament Audits screen, accessed from the Tournament Menu. These numbers cannot be reset by the operator during a tournament and stay up for about a week after a tournament ends. The statistics on this screen are reset to zero by the ITS before the start of each tournament.

How often do you transfer funds from my account?

The ITS bills one time at the end of each tournament. You will be faxed or mailed a statement about 4 days after the end of the tournament. This statement shows the tournament activity on each of your ITS machines, and the total amount owed to the ITS. A transfer date is also displayed, which is usually about 6 days after the statement is faxed or mailed. You must have the full amount in your account by this date. Any questions or discrepancies should be handled before this transfer date.

The billing statement doesn't match my collection numbers. What should I do?

A second set of tournament statistics are stored in the test software, in the Tournament Audits screen, accessed from the Tournament Menu. These numbers cannot be reset by the operator during a tournament and stay up for about a week after a tournament ends. Use this screen to verify the tournament numbers of your machine. Remember, this screen is reset to zero by the ITS a few days before the start of each tournament.

How come the standings on the Leaderboards sometimes change after a tournament ends?

The ITS collects data from all machines at the end of the day. Because of this, the Leaderboards are usually a day behind and need an extra day to catch up with real-time play. The ITS collects and processes the final data to determine final standings. Sometimes this takes a few days, due to unattended or off-line games. When the final data is collected, it is processed to eliminate ineligible players and invalidated entries. The final Leaderboards are then sent back to the games at the next call. This process may take a few days.

How do I let my locations know who won?

After the final data is processed, the ITS generates posters of National, Regional, and Local winners. Winners posters for each of your locations are mailed to operators about one week after the tournament ends. Operators are required to post these posters at each location for at least 90 days.

How does a winner claim a prize?

A player calls the ITS to claim his prize. The player's name, address and social security number is taken and a Verification Form is sent. The form must be signed and sent back, along with some form of proof of social security number, such as a drivers license. After the Verification Form is returned and processed, the ITS sends the player his check. The ITS pays all prizes to players. The collected funds sent to the ITS at the end of the tournament are used to pay out prizes. Players call the ITS to claim their prize. The operator and location do not pay prizes.

APPENDIX F

Warranty Information

If the original purchaser discovers any physical defect in the media (disk, EPROM, tape) on which the software is distributed or in the documentation, which in the opinion of Incredible Technologies, Inc. (IT) prevents the product from being used as reasonably intended, IT will replace the media or documentation at no charge. The purchaser must return the item to be replaced, with proof of purchase, to IT within 90 days after taking delivery of the software.

IT warrants to the original purchaser that the hardware product is in good working condition for a period of 90 days from taking delivery of the product. Should this product, in IT's opinion, malfunction within the warranty period because of a defect in design, materials, or workmanship, IT will repair or replace this product without charge under the terms as follows. Replacement of either the hardware product or its component parts will be only on an exchange basis. Any replaced parts or components become the property of IT. This warranty does not apply to those products which have been damaged due to accident, abuse, improper installation, natural disaster, or unauthorized repairs or modifications.

IT excludes any and all implied warranties, including warranties of merchantability and fitness for a particular purpose, and limits the purchaser's remedy to returning the software, hardware, or documentation to IT for replacement.

IT makes no warranty or representation, either express or implied, with respect to this software, hardware, or documentation, their quality, performance, merchantability, or fitness for a particular purpose. This software, hardware, and documentation are licensed "as is," and the purchaser/licensee assumes the entire risk as to their quality and performance.

In no event will IT be liable for direct, indirect, special, incidental, or consequential damages arising out of the use or inability to use the software, hardware, or documentation, even if advised of the possibility of such damages. The warranty and remedies set forth above are exclusive and in lieu of all others, oral or written, express or implied. No person, seller, dealer, agent, or employee is authorized to make any modification or addition to this limited warranty.

Some states do not allow the exclusion of implied warranties or liability for incidental or consequential damages, so the above limitation or exclusion may not apply to you. This warranty gives you specific legal rights, and you may also have other rights that vary from state to state.

- INCREDIBLE TECHNOLOGIES, INC.
06/99