

SHOWPIECE MANUAL AND USER GUIDE



WARNINGS AND NOTICES

NOTICE

- This game is intended to be operated for amusement purposes only. It is not to be operated in violation of any federal, state, or local laws or regulations. As the owner and/or operator of this game you are responsible for its operation in compliance with such laws and regulations. The factory settings for this game may require adjustment in order to comply with the laws and/or regulations in the jurisdiction where the game is located. It is the sole responsibility of the operator to determine what laws and/or regulations are applicable and to make any adjustments to the game before operating it for its intended purpose.
- This manual and the information contained within is subject to change without notice.
- The Showpiece cabinet is intended for use with the Showpiece Integrated Stand (Model 304S).

WARNING

- Use of unauthorized parts or making any unauthorized modifications will void the warranty and may result in the game operating in an unsafe or incorrect manner.
- If the supply cord is damaged, it must be replaced by a special cord or assembly available from the manufacturer or its service agent.
- This cabinet is not suitable for installation in an area where a water jet would be used. The cabinet must not be cleaned by a water jet.

WARRANTY, REPAIR, AND RETURN POLICY

- 90-day warranty on all electronic components. All warranty periods begin on the date of purchase from Incredible Technologies, Inc.
- There is a minimum \$75.00 service charge for all non-warranty repairs or returns.
- For all servicing, return to Incredible Technologies, Inc.
- ANY non-factory repair or attempted repair voids warranty.

RETURN MERCHANDISE AUTHORIZATION

- All returned merchandise must have a Return Merchandise Authorization (RMA) number marked clearly on the outside of the package.
- You must obtain all RMA numbers from Incredible Technologies. Please have the product's Cabinet Identification Device (CID) number available when calling for an RMA number.
- Merchandise returned without an RMA number will not be accepted.
- Warranty may be void if serial number or security labels are tampered with or removed. **Opening the Nighthawk Chassis system will void your warranty.**
- Advance replacement hardware will be shipped to the customer address on file unless specified otherwise.
- Advance replacement hardware will be billed to the customer until Incredible Technologies, Inc. receives the returned merchandise, at which time a credit will be issued.
- All repairs and/or replacements will ship as soon as possible after receipt or request (subject to availability).

PAYMENT FOR AND STORAGE OF REPAIR MATERIALS

- Materials sent to IT for repair must be paid for according to current price schedules and in a reasonable time. Storage fees for repaired equipment will be charged at a rate of \$50.00 (Fifty US Dollars) per calendar month or fraction thereof after 90 (Ninety) days from notice to the customer that the repairs are complete. IT reserves the right to resell repaired equipment to cover accumulated storage charges when the accumulated storage charge reaches 100% (One Hundred Percent) of the repaired items' then-current replacement cost.

- INCREDIBLE TECHNOLOGIES, INC

PERPETUAL SOFTWARE LICENSE

Incredible Technologies, Inc. ("IT,") hereby offers you ("Licensee") the right to install and use certain copyrighted computer software produced by IT under the following terms and conditions. This License shall govern the use of the software known as "Silver Strike LIVE" ("Update") when applied as an update to pre-existing Silver Strike-equipped hardware ("SS Cabinets") equipped with an earlier version of the Silver Strike Bowling software ("Prior Version") or to Updates included in the purchase of a hardware/software package which constitutes a functionally complete Silver Strike LIVE game unit.

1) Licensing Fee

The Licensing Fee ("LF") shall be as follows:

- US\$0.00 (Zero United States Dollars and zero cents.)

2) Term

The License shall be valid on the first date that both the LF is paid for the Update and it is installed on an SS Cabinet. If you purchased the Update under a payment arrangement where the Update is paid for in more than one (1) installment, you purchased the Update under the terms of a Term Software License. If the Update has been offered or sold to you under the terms of a Term Software License, the terms of this License shall become applicable if and when the Term Software License terminates in favor of this Perpetual Software License, as set forth in the Term Software License. The term shall be perpetual and throughout the Universe for the Update on the SS Cabinet upon which it is installed at the time the LF is paid. Updates are not transferrable to any other SS Cabinet, for any reason. If an SS Cabinet with an Update is destroyed or otherwise taken out of operation, this License shall terminate.

3) License Rights

Licensee shall have the right to utilize the Update on authorized SS Cabinets in the normal course of business and as controlled by the Rules of ITNet, as set forth in a separate "Operator Agreement" document, the terms and conditions of which, where not conflicting with the terms and conditions herein, are hereby incorporated by reference. Updates may only be operated on SS Cabinets which are installed in commercial locations, as that term is defined by IT, and to which there is general access by all parties with a general right to enter the location where the SS Cabinet is operated.

4) Legal Operation

Updates include various features which may not be lawful to operate in any given jurisdiction. No provision of any feature, or its licensure to Licensee under the terms herein shall be deemed as advice that operation of that feature is lawful or not lawful in any given jurisdiction. Licensee shall make reasonable efforts to disable any user-adjustable feature which they know or should have known as not lawful to operate in the location where an SS Cabinet with an Update is being operated.

5) Termination and Rollback

In the event that this License is terminated for whatever reason, Licensee shall have absolutely no right to operate any SS Cabinet upon which an Update has been installed. IT reserves the absolute right, at its sole discretion, to terminate the operation of any SS Cabinet upon which an unlicensed Update is installed. If Licensee wishes to restore such an SS Cabinet to operating condition without acquiring a new License for the Update, IT will roll-back that SS Cabinet, at no charge to the Licensee, to the Prior Version upon return (at Licensee's expense) of the required hardware to IT's service center.

6) Governing Law and Jurisdiction

The validity and construction of this License and of the rights and obligations set forth herein shall be determined and governed by the laws of the State of Illinois. The parties hereby submit to the Jurisdiction of any state or federal court in Cook County Illinois. Licensees operating outside the borders of the United States of America, regardless of their citizenship or residency, explicitly agree to allow any assets they may have in the USA or any other foreign country to be attached, garnished, forfeited or otherwise reached by any legal act if, after due process of law, they are found to be liable to IT for damages by reason of breach of this License.

7) Warranty

If the Licensee discovers any physical defect in the media (disk, EPROM, flash media, etc.) on which the Update is distributed or in the documentation, which in the opinion of Incredible Technologies, Inc. (IT) prevents the product from being used as reasonably intended, IT will replace the media or documentation at no charge. The purchaser must return the item to be replaced, with proof of purchase, to IT within 90 days after taking delivery of the Update.

8) Disclaimer and Waiver of Remedies

Acceptance of this License and installation of the Update includes disclaimer and waiver of any and all implied, statutory, or common-law warranties, including warranties of merchantability and fitness for a particular purpose, and limits the purchaser's remedy to returning the Update to IT for replacement.

IT makes no warranty or representation, either express or implied, with respect to Updates, their quality, performance, merchantability, or fitness for a particular purpose. Updates are licensed "as is," and the Licensee, by installing the Update, assumes the entire risk as to their quality and performance other than as explicitly set forth herein.

Acceptance of this License and installation of the Update includes disclaimer and waiver of any and all direct, indirect, special, incidental, or consequential damages arising out of the use or inability to use the Update, even if advised of the possibility of such damages. The warranty and remedies set forth above are exclusive and in lieu of all others, oral or written, express or implied. No person, seller, dealer, agent, or employee is authorized to make any modification or addition to this limited warranty.

In jurisdictions which do not allow the exclusion of implied warranties or liability for incidental or consequential damages, acceptance of this License and installation of the Update includes stipulation that the most minimal requirements of the law of those jurisdictions shall govern any additional required additional rights of Licensee.

9) Severability

If any provision of this License shall be held by a court of competent jurisdiction to be illegal, invalid or unenforceable, the parties nevertheless agree that the court should endeavor to give effect to the parties' intentions as reflected in the provision, and the remaining provisions shall remain in full force and effect.



Silver Strike X Manual & User Guide

TABLE OF CONTENTS

TABLE OF CONTENTS	1
SHOWPIECE CABINET	4
Mount Main Screen Display	4
Leg Leveler Adjustment	4
Connect USB Cables	4
Install Marquee.....	4
HDTV DIP SWITCH SETTINGS and NIGHTHAWK SYSTEM BOX.....	5
Video Connections for HDTV	6
Final Check.....	7
Apply Power	7
General Cabinet Maintenance.....	8
Care and Cleaning of Rubber Bumper	8
Nighthawk Air Filter	8
Trackball Maintenance.....	8
Care and Cleaning of Cooling Fans and Vents	8
Showpiece Cabinet Repair Procedures	9
System Box.....	9
I/O Board.....	9
Cash Vault.....	10
Control Panel	11
Speakers	12
OFFLINE KIT CONTENTS.....	13
Kit Installation	13
Recommended Tools.....	13
Installation Preparation	13
Preparing The Cabinet	14
Cabinet Selection.....	14
Preparing the Cabinet for Installation.....	14
Check Harness and Wiring	14
Check Coin mechanisms and Bill Acceptor	14
Check Coin Door Connections.....	15
Check High-Definition Television.....	15
Remove Cabinet Graphics.....	15
Remove Existing Card Reader (If applicable).....	15
Vacuum Cabinet.....	15
Electronics Installation.....	16
Install Nighthawk SYSTEM Box.....	16
Install Cabinet Identification Device (CID)	16
Install I/O Board	17
Trackball and Button Preparation (For Most Kits).....	17
Control Panel Overlay Installation.....	18
Finishing The Control Panel.....	19
Complete System Box Connections.....	20
Attach I/O Power, Audio and USB cables.....	20

Attach Main Video Cable	20
Attach Power Cable	20
Complete I/O Board Connections.....	21
Connect Input/Output Connection Cable to I/O Board.....	21
Connect the Control Panel Switches and Cable.....	21
Connect Coin Door Lamps.....	21
Connect the Trackball	21
Connect the USB Cable.....	21
Connect High-Definition Television.....	21
Connect I/O Power Cable	21
Check All Connections.....	21
Cabinet Marquee Installation.....	22
Final Connections.....	23
Coin Doors, Test Switch and Volume Control	23
Initial Power-Up.....	23
Silver Strike X System Setup Menus	24
SYSTEM SETUP MENUS.....	24
Main Menu	24
Collections & Earnings Menu.....	25
Do Collection.....	25
General Settings	26
Operator Adjustables	27
General Adjustments	27
Money Slot Adjustments	28
Sound Adjustments	28
Collection Settings	29
Reset to Factory Settings.....	30
System Tests	31
Video Tests	31
Color Adjustments.....	32
Contrast Adjustments.....	32
Screen Size Adjustment.....	32
Sound Tests	33
Player Control Tests	33
Mechanical Meter Test.....	33
Hardware Tests.....	34
Hardware/Software	34
System Info	34
USB Info.....	34
Version Info.....	34
Check Hard Drive.....	35
Check Cooling.....	35
Troubleshooting Shortcuts	36
Silver Strike Settings.....	36
Player Cost Schedule	37
Game Audits	37
Game Options	39
BEER frame Spotlight.....	40
Reset Leaderboards	40
Ticket Dispenser	40
ITNet Settings	40
Silver Strike X Troubleshooting Guide & Reference	41
Appendix A Troubleshooting Guide	41
Appendix B Input/Output Connections (I/O Power, Trackball, etc.).....	46
Appendix C Replacement Part NUMBERS	47
Appendix D System diagrams.....	48
Appendix E.....	53
Appendix F Menu Navigation Shortcuts	55
Game Icon Descriptions.....	55
APPENDIX G Mounting Templates	57
Trackball Mounting Template.....	59

NOTE
PLEASE RETAIN ORIGINAL SHIPPING BOX FOR SERVICE AND REPAIR.

Do NOT perform any installation or repair when the cabinet is powered on. Make sure the cabinet is unplugged from all power sources before and during installation.

Some game features may not be allowed in certain state or local jurisdictions. Be sure to check your local laws before activating or allowing any features that may be questionable in your area. Adjust game settings from the System Setup Menus. Refer to this manual for details.

Incredible Technologies cabinets are shipped with the USB cables disconnected from the I/O Board and the Cabinet Identification Device (CID). This prevents vibrations during shipment from damaging the contacts on the connectors. These cables must be connected before operating the equipment. IT recommends disconnecting these USB cables whenever transporting the unit.

SHOWPIECE CABINET

Showpiece Cabinet Contents

(1) Silver Strike X Showpiece Cabinet

Shipped inside a plastic parts bag attached to the front of the cabinet:

- (1) Marquee Header
- (1) Power Cord
- (1) Setup Guide
- (1) HDMI Cable

Shipped inside the cardboard sleeve on the top of the control panel:

- (2) Marquee Header Brackets

NOT Included with your Showpiece Cabinet

You will need to supply a digital display for the game's main monitor, and an appropriate stand or wall mount. Incredible Technologies recommends a 42" HDTV that supports 720p for the best presentation, game play and earnings potential. A list of Recommended Mounting Solutions can be found under Purchasing Info and Specs at the following address on the IT web site:

<http://amusement.itsgames.com/games/silver-strike-live/specs>

MOUNT MAIN SCREEN DISPLAY

Position the Showpiece cabinet in front of the ideal location for a HDTV. The HDTV is intended for use with the Showpiece Integrated Stand (Model 304S) but can also be mounted to a wall. Be sure that the top of the Showpiece cabinet has at least 24" clearance in all directions. Insufficient clearance may result in damage to your display or player injury. Recommended height for your display may vary depending on your location and player base. As a general rule, the minimum height of the bottom of the display viewing area should be 42" from the floor.



LEG LEVELER ADJUSTMENT

Once your game is in position at the location, it is necessary to adjust the leg levelers. The leg levelers will help stabilize the game on an uneven floor, and help it from moving or shifting during game play. The game is shipped with the two front and two rear leg levelers installed. Adjust the levelers as necessary to level and stabilize the game.

CONNECT USB CABLES

The USB cables from the Nighthawk system box to the Cabinet Identification Device (CID) and I/O Board ship disconnected. To connect them, unlock and lift open the player control panel to access the cables and electronics. The two cables and boards are on the left side. (The USB cables are identical and interchangeable.)

INSTALL MARQUEE

Your Showpiece cabinet comes with a framed marquee header that can be easily attached to the top of your monitor. The brackets for the header are shipped inside a separate cardboard insert labeled *Parts – Do Not Discard* within the cabinet packaging. The insert is located on the top of the control panel.

First, attach the two brackets to the back of the universal mounting plate you are using for your HD display. The brackets share the same screws used to affix the display to the mounting plate, and are sandwiched between the plate and the back of the monitor. Once the brackets are in place, slide the marquee frame onto the clips on the two newly mounted brackets. Be sure the tab on the clips rest inside the channel on the marquee frame.

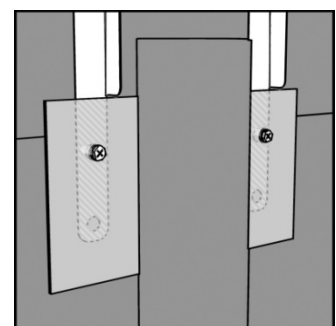
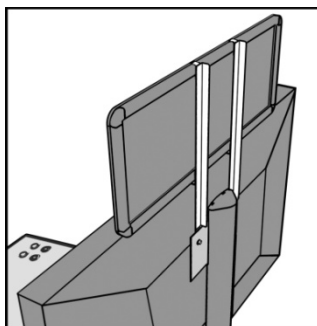

HDTV DIP SWITCH SETTINGS AND NIGHTHAWK SYSTEM BOX

Before making any Nighthawk connections, make sure the USB cables are connected for the I/O Board, and CID. See Complete System Box Connections for details.

Nighthawk System Box

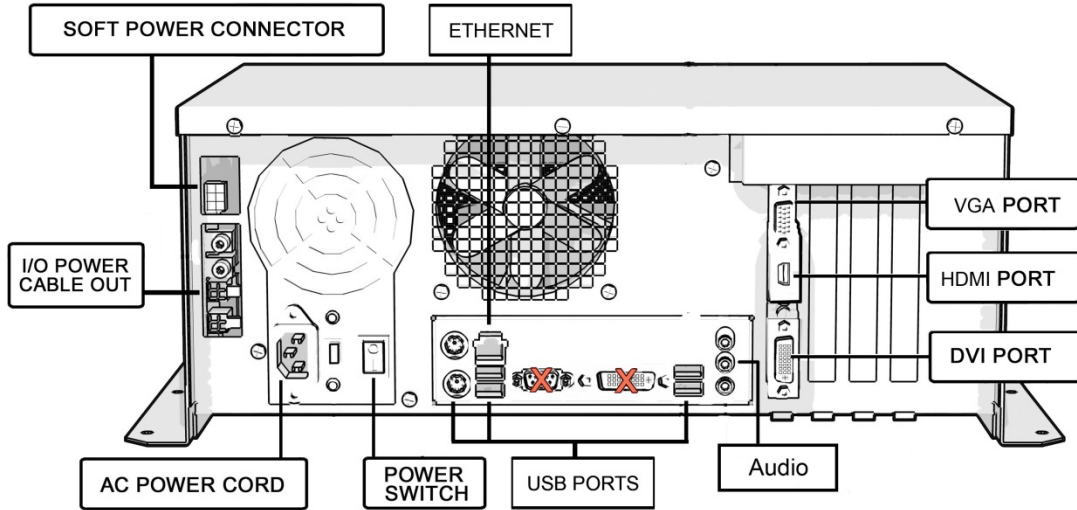

DIP Switch Settings for HDTV

The DIP switch settings in your Showpiece cabinet have been factory set to accommodate a 720p HDTV connected through HDMI cables. DIP switch bank Sw201 on the I/O Board controls the video resolution for the main monitor. If using a DVI-D or VGA connection, use this chart:

HDTV MONITOR APPLICATION

IMPORTANT NOTE
I/O CARD DIAGRAM FOR ORIENTATION

RESOLUTION SETTINGS

<input type="checkbox"/> 1 <input type="checkbox"/> 2 <input type="checkbox"/> 3 <input type="checkbox"/> 4 OFF ON	<input type="checkbox"/> 1 <input type="checkbox"/> 2 <input type="checkbox"/> 3 <input type="checkbox"/> 4 OFF ON
1280 x 720 (DVI-D) 720p	1280 x 720 (SVGA) 720p
<input type="checkbox"/> 1 <input type="checkbox"/> 2 <input type="checkbox"/> 3 <input type="checkbox"/> 4 OFF ON	<input type="checkbox"/> 1 <input type="checkbox"/> 2 <input type="checkbox"/> 3 <input type="checkbox"/> 4 OFF ON
1280 x 720 (HDMI) 720p	DEFAULT

Sw201 Sw200 Sw202

OFF ON OFF ON OFF ON

Sw200 ALWAYS ON
Do Not Change
Settings shown for Showpiece

ADDITIONAL SETTINGS

<p>Primary Monitor</p> <input type="checkbox"/> 1 <input type="checkbox"/> 2 <input type="checkbox"/> 3 <input type="checkbox"/> 4 OFF ON <p>Primary Monitor has 16 x 9 Aspect Ratio DEFAULT</p>	<p>Secondary Monitor</p> <input type="checkbox"/> 1 <input type="checkbox"/> 2 <input type="checkbox"/> 3 <input type="checkbox"/> 4 OFF ON <p>Optional 2nd Monitor has 16 x 9 aspect ratio DEFAULT</p>
<p>System Setup</p> <input type="checkbox"/> 1 <input type="checkbox"/> 2 <input type="checkbox"/> 3 <input type="checkbox"/> 4 OFF ON <p>Enter System Setup Menus DEFAULT</p>	<input type="checkbox"/> 1 <input type="checkbox"/> 2 <input type="checkbox"/> 3 <input type="checkbox"/> 4 OFF ON <p>Do Not Flip Optional 2nd Monitor DEFAULT</p>
<input type="checkbox"/> 1 <input type="checkbox"/> 2 <input type="checkbox"/> 3 <input type="checkbox"/> 4 OFF ON <p>Exit System Setup Menus DEFAULT</p>	<input type="checkbox"/> 1 <input type="checkbox"/> 2 <input type="checkbox"/> 3 <input type="checkbox"/> 4 OFF ON <p>Vertical Flip Optional 2nd Monitor</p>

Note: In the Additional Settings above, ONLY the ON switch matters for correct setup and operation.

Notes:

A reboot is required when changing resolutions. Video and audio connections to HDTVs vary, and may require additional cables not included with the Showpiece cabinet. Also, some displays may not support the resolution needed for your game. Check your display's manual for additional information.

VIDEO CONNECTIONS FOR HDTV

Your main display monitor must have at least a 720p (1280x720) resolution. Be sure your HDTV is compatible.

For any questions related to Showpiece cabinet connections, see the Showpiece Cabinet A/V Connections Guide under Showpiece Cabinet at <http://amusement.itsgames.com/service/manuals>

Follow the instructions below to set up your HDTV and Showpiece cabinet.

Connect to HDMI

Connect the HDMI cable (supplied) to the HDMI output on the Nighthawk system. Route the cable through the clip under the lock on the back wall, and down through the access panel on the back of the cabinet. Connect the other end of the HDMI cable to the proper HDMI input on your HDTV.

Set Up HDTV

Refer to the HDTV manual to adjust the video signal to match the correct input for your game. Selecting the correct input is commonly found from a system menu accessed from the remote, or an Input Select button on the HDTV.

Connect AC Power Cord

Connect the cabinet AC power cord to a wall outlet and turn on the cabinet power switch.

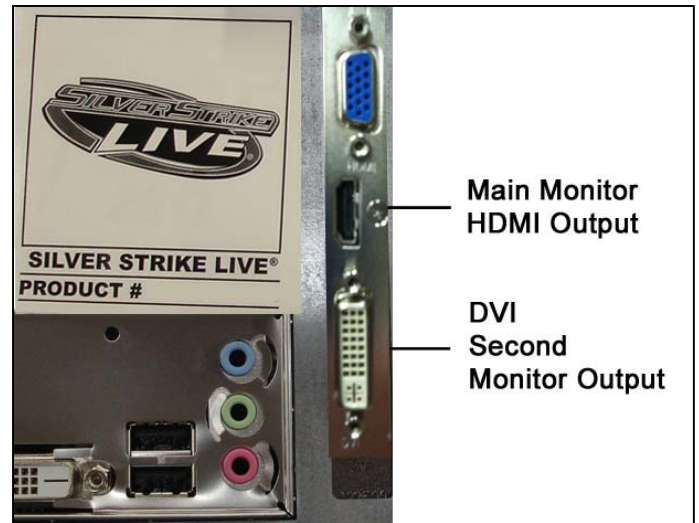

Audio Connections for HDMI

The HDMI cable will also supply audio to the speakers on your HDTV. See Audio/Video Connections Table below for details on other connection types.

Audio/Video Connections Table

Video Mode	Primary Video Connector	Audio
1280x720 (HDMI) 720p	HDMI with HDMI Cable	Digital – Via HDMI cable
1280x720 (DVI-D) 720p	DVI-D to HDMI	Analog – Via 3.5mm Y-audio from I/O Board to Nighthawk (green port)
1280x720 (SVGA) 720p	VGA	Analog – Via 3.5mm Y-audio from I/O Board to Nighthawk (green port)

CAUTION:

Incredible Technologies cabinets are shipped with the USB cables disconnected from the I/O Board and the Cabinet Identification Device (CID). This prevents vibrations during shipment from damaging the contacts on the connectors. These cables must be connected before operating the equipment.

IT recommends disconnecting these USB cables whenever transporting the unit.

FINAL CHECK

APPLY POWER

Connect the power cable to the socket on the back of the cabinet. Then plug the cable into a 3-pronged, grounded wall socket. Locate the power switch on the back of the cabinet and turn it ON.

Note: If the supply cord is damaged, it must be replaced by a special cord or assembly available from the manufacturer or its service agent.

Watch the game carefully when you first turn it on. Look and smell for smoke. Turn it OFF immediately if there is smoke. Make sure the fan inside the system box is running and the LEDs on the I/O Board are flashing. If not, something is wrong, turn off the game. The power supply fan only runs when the machine needs cooling.

Check the Cabinet ID Device (CID) Number

Watch the screen during boot-up and wait for the Silver Strike X boot verification screen to appear. Note the Cabinet ID Number (CID) that appears on this screen, and verify that it matches the CID number printed on the back of the cabinet. The screen will automatically time out and boot-up will continue.

Check the Coin Switch and Bill Validator

Try the coin switch. Drop quarters or tokens through to check the coin mechanism. Insert a dollar bill into the bill validator and listen for the credits to ring up. Make sure the game is adding credits and the correct quantity. You can use the Player Control Test by pressing the System Setup button inside the coin door and entering the *System Tests Menu*. Make sure all of the controls work.

Cabinet Temperature

The state of the art Nighthawk hardware is extremely powerful, and therefore generates a substantial amount of heat. Measures have been taken to keep the various components cool during normal use. If overheating occurs, game play and hardware longevity may be affected. Use the Check Cooling menu in the System Setup menus to monitor the temperature within your cabinet. Enter System Setup by pressing the System Setup button inside the outer door of the coin vault. Once at the main System Setup menu, use the trackball and Start button to select *Troubleshooting Shortcuts*, then *Check Cooling*.



Custom Adjustments

Upon initial power-up, the game will initialize to factory default settings. These settings affect game elements such as number of credits per coin, volume settings, etc. The System Setup section in your game manual will describe how to alter these settings and view the system audits or run system tests.

GENERAL CABINET MAINTENANCE

Games that are in good working condition, with clear monitors, clean control panels and working trackballs will make more money than a machine in poor condition. It is definitely worth your time and attention to protect your investment with a little common care. Each week, clean the display and wipe down the control panel to bring back that new game look. Test the trackball and buttons regularly to make sure they are playing properly. And perhaps most important, make sure the coin mechanisms and bill acceptors are in good working order.

CARE AND CLEANING OF RUBBER BUMPER

The rubber bumper on the front of the cabinet's control panel is made from durable nitrile rubber. Clean it using a mild soap and water solution or blue window cleaner.

NIGHTHAWK AIR FILTER

The Nighthawk System Box comes equipped with an external electrostatic air filter. This filter is held in place by a metal bracket, attached to the system box. The filter prevents debris from entering the system box and damaging the electronic components. A clogged filter will impede airflow, thus building up unwanted heat which can cause damage to your hardware. Be sure to check this filter at least once a month. Remove the filter by sliding it out of its housing. Shake off excess dirt and if necessary clean it with soap and water. Be sure the filter is completely dry before reinstalling the filter.

TRACKBALL MAINTENANCE

The trackball will require periodic maintenance to assure optimum performance. In most cases the inside of the trackball simply needs to be cleaned of any accumulated dust and debris. See page 12 for Trackball Replacement.

To access the inside of the trackball, remove the 6 Phillips head screws that hold the trackball together and remove the top cover. Clean out any dust and debris inside the trackball. Polish the rollers and remove any foreign material that may be on the rollers. Do not lubricate the bearings, as this will only attract more dust. If the bearings do not spin freely it is best to replace the bearing assembly. Inspect the rollers for any nicks that may cause poor performance and replace if needed. Inspect the ball for any nicks and replace if needed. Parts can be obtained from Happ Controls and is an economical option rather than replacing the entire trackball assembly.

It is critical that the green field ground wire be properly connected to field ground. This prevents the trackball from building a static charge that can cause the game to lock up or reset. A static discharge can also damage the trackball's electronic components, as well as the main system.

CARE AND CLEANING OF COOLING FANS AND VENTS

The hardware that runs Silver Strike X is quite sophisticated, and many of the chips and processors will get hot very quickly. Like your desktop PC, the Silver Strike X hardware needs adequate ventilation to work properly. Dust and dirt can be a major cause to overheating and will lead to costly repairs. At least once a month, check to make sure the cabinet and system box fans are working and free of dust and debris. Use a vacuum to clear all the ventilation holes on the cabinet at this time as well.

SHOWPIECE CABINET REPAIR PROCEDURES

SYSTEM BOX

The Nighthawk System Box houses most of the game electronics and hardware in one box that can be easily installed. As with all electronic equipment, the system box should be handled with extreme care. Shock, severe temperature, or sudden impacts can damage the internal components that require costly repair.

Note: Turn off power to the cabinet and remove the power cord from the back of the cabinet when performing any of the following.

System Box Removal

1. Unlock the control panel and open to expose the Nighthawk system box.
2. Disconnect all connections to the system box. Be sure all wires and connectors are clear and out of the way. Label the connectors for easy reconnection.
3. Loosen the 6 ¼" hex-head screws that secure the system box.
4. Carefully lift the system box off the screws and up out of the cabinet.

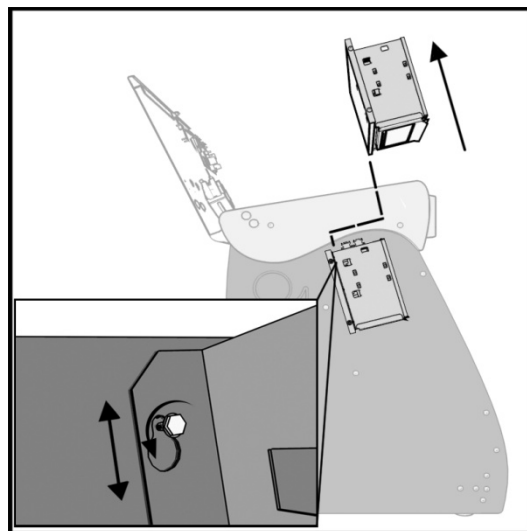

System Box Installation

1. Unlock the control panel and open to expose the inside of the cabinet.
2. Align the system box onto the 6 mounting screws of the internal slanted panel. The connection ports face up. Once the system box is in place, tighten the 6 ¼" hex-head screws to secure the box to the panel.
3. Connect the required connections. See the Connections Diagram for more details.

I/O BOARD

Note: The I/O Board is game title specific and is not interchangeable with other game titles produced by Incredible Technologies on this system. Dedicated and Retrofit Kit I/O Boards are different and are not interchangeable.

I/O Board Removal

First, unlock the control panel and open to expose the interior of the Showpiece cabinet. Disconnect all connections from the I/O Board. Label the connectors for easy reconnection and move them safely out of the way. Next, remove the six ¼" wood screws that secure the board to the interior left side of the cabinet (as you face the game). Carefully remove the I/O Board from the cabinet.

I/O Board Installation

Place the I/O Board in the proper location on the interior left side of the cabinet (as you face the control panel of the game). Be sure it is oriented properly so the cables reach the board (the USB port on the I/O Board facing the top of the cabinet). Secure the I/O Board to the side of the cabinet with the six ¼" wood screws. Use the factory mounting holes if at all possible. Be sure the board does not "bow" or is not stressed in any way. Once mounted, connect the appropriate connections.

Cabinet Identification Device (CID)

This device contains a specific ID number that identifies your cabinet. The CID is a permanent number and must be connected to the main system box via the USB cable and working properly in order for the game to operate.

CID Removal and Replacement

If for some reason you must replace the CID, disconnect the USB cable from the CID. This is the only connection to the CID. Next, remove the four ¼" wood screws that secure the CID to the interior left side of the cabinet (as you face the game). The CID is located above the I/O Board. To install a CID, mount the CID in the proper location using four ¼" wood screws. The CID should be mounted so the USB port is facing the top of the cabinet and the electronics are facing the wall.

Note: The Cabinet Identification Device should NEVER be removed from the cabinet, even when replacing any of the other components. The CID is the cabinet's PERMANENT Identifier, regardless of any other components.

CASH VAULT

The Cash Vault has been designed for optimal security. With the double-locking doors, service technicians can read meters and enter System Setup mode with no access to the cash box.

Cash Vault Removal and Replacement

- 1) Unlock and open the outer door of the Cash Vault.
- 2) Using a T-15 Torx wrench, unscrew the card reader/button plate located on the right side by removing the four #8-32 screws located at the top and bottom of the plate.
- 3) Unplug the cable from the card reader, and disconnect the connectors for the coin meter and buttons.
- 4) Remove the plate and set it aside.
- 5) Remove the coin bin and the bill validator magazine to make it easier to work inside the vault.
- 6) Unplug the bill validator cables, and push the cables for the bill validator, card reader, buttons, and coin meter through the 2 holes located in the back of the vault.
- 7) The Cash Vault is attached by upper and lower locking brackets. These are each attached with two socket-head screws located within the vault.
- 8) Locate the socket-head screws on the top and bottom locking brackets. Remove the two bottom screws using a 9/64" hex key and remove the bottom locking bracket. Make sure to note how it was installed.
- 9) Remove the two top screws and remove the top locking bracket, again noting how it was installed.
- 10) You can now pull the entire vault assembly out from the front of the cabinet. The vault is attached with foam tape, so it will need to be pried out or pushed from behind to loosen the adhesive.
- 11) Reverse the procedure to install the new door.

Locks

The outer lock is a secure T-handle lock, commonly used in vending. To open, insert the key and turn it clockwise until the lock-handle pops out. Next, rotate the lock-handle clockwise 90 degrees to open the outer door.

The inner door has a lock installed above the System Setup button. This lock is unlocked by turning the key 90 degrees clockwise.

Volume and Service Buttons

Mounted inside the outer door are controls for Volume and System Setup. Press the Volume Up button to increase the loudness of the sounds on the game, and press the Volume Down button to make your game quieter. Press the System Setup button to access the game's software menu system. The System Setup menus cover a variety of important areas including collections, tests, game adjustments, and optional settings.

Bill Acceptor

The dedicated cabinet ships with a MARS AE2681 D5 bill acceptor and is mounted on the cash vault door. The default dipswitch settings for this acceptor are ON = 1, 2, 4-7 and OFF = 3, 8.

Bill Acceptor Removal

Disconnect the cable to the bill acceptor. Remove the four 11/32" sized nuts from the mounting studs. Disconnect the ground wire from the one lower stud. Then gently pull the acceptor off the studs from the back side of the coin door.

Bill Acceptor Installation

From the back side of the coin door, place the bill acceptor onto the four mounting studs. The faceplate will protrude out the front of the coin door. Place the field ground wire on a lower stud, and install the four 11/32" sized nuts on the mounting studs and tighten. Next, connect the bill acceptor cable in the cabinet to the mating cable on the bill acceptor itself.

Stacker Removal

A blue slide switch is located at the bottom of the stacker. Engaging it allows the stacker to be removed.

Coin Mechanism Removal

Loosen the two finger screws to release the securing braces. Slide the upper brace upward, and the lower brace downward. The mechanism should pull straight out.

Meter

This 5-volt device is mounted behind the card reader plate next to the inner door of the coin vault. One lead of the meter is connected to a +5 volt source and the other lead is connected to the appropriate signal wire. An additional opening is available just below the meter, if a second meter is desired.

CONTROL PANEL

Opening the control panel provides access to all game controls and hardware components. To open the control panel, simply use the supplied key in the lock on the back of the cabinet and lift from the back. The control panel is hinged in front and will stay open when fully extended.

Soft Power Switch

A "soft power" switch has been added to the underside of the control panel, to assist in the update process. This switch will turn off power to the Nighthawk system box so you don't have to reach around to the main power switch located on the back of the cabinet.

Note: If you turn power off using the Soft Power Switch, you must use this same switch when turning power back on.

Trackball Replacement

To replace a trackball, open the control panel and remove the 4 long screws holding the trackball in place. Be careful not to lose any of the screws, washers and lock washers. Disconnect the wire harness and ground wire and remove the old trackball. Position the new trackball in the proper orientation over the existing standoffs. Make sure that the arrow on the trackball that points to the monitor is pointing up. Replace the 4 long screws and washers. Do not over tighten! Screw in until the lock washer is fully compressed. Reconnect the wiring connector and ground wire.

Note: The field ground wire is critical to avoid electrical problems and assure optimal performance.

Button Replacement

All of the buttons on the control panel require a 1 1/8th inch hole, and are pre-drilled on the dedicated control panel. To remove a button, disconnect the wires from the button assembly by sliding the wires off of the micro switch posts. Next carefully twist the micro-switch assembly off of the button posts. Finally, unscrew the nut to remove the button from the control panel.

Place the new button assembly into the hole and position the smaller side of the micro-switch housing to face the rubber bumper, angled towards the middle. Tighten the supplied nut using a pushbutton wrench. Do not over tighten. Install the micro-switch by snapping it onto the pushbutton assembly by hand. Position the assembly so the micro switch posts face the rubber bumper, angling towards the middle. Reconnect the wires by sliding the wire assembly onto the contact posts of the appropriate micro switch. See the wiring diagram in Appendix D.

Control Panel Removal

To remove the control panel from its hinge, Disconnect the trackball cable, field-ground wire, and the control panel interconnect connector to the I/O Board. Remove the screw that attaches the safety cable to the control panel. Remove the four 1/4" screws holding the panel to the hinge.

Control Panel Graphics Removal

The control panel artwork has been screened onto a solid sheet of polycarbonate, which is resistant to scratches and burns. Unfortunately long exposure to excessive situations may damage the surface over time. To remove and replace this piece, the pushbutton and trackball assemblies must first be removed. Separate the polycarbonate piece from the wood portion of the panel by starting at one corner and slowly peeling the two apart. The overlay has adhesive on the entire surface and will take some force to separate the pieces due to the adhesive. Once removed, the graphic overlay will not be able to be used again.

Control Panel Graphics Installation

To install a new polycarbonate graphics overlay, make sure the wood control panel surface is clean, smooth, and free from glue, dirt and debris. Remove the paper protecting the adhesive from the new artwork/cover panel. Carefully place it on the wood panel, aligning it properly. Press and smooth firmly to assure that it is secure. Replace the buttons and trackball in the correct orientation.

SPEAKERS

The speakers are mounted in the bottom front of the cabinet, just below the coin vault. Sounds and speech are important aspects to the play experience and should be adjusted and maintained for optimal results. Make sure your speakers are in good working condition, are wired correctly, and are grounded properly to avoid buzz or hiss.

Speaker Access

To access the speakers, remove the back panel of the cabinet by unbolting the four connector bolts. The speakers are located just below the coin vault. Remove the 4 nuts with an 11/32" nut driver to remove the speakers from their mounting.

Note: Both speakers must be identically wired to work. For optimal sounds, both speakers must be in phase with one another. Be sure the positive wire is connected to the positive terminal of each speaker and the negative speaker wire is connected to the negative terminal of each speaker.

OFFLINE KIT CONTENTS

Please refer to the IT part numbers in Appendix C when ordering parts.

- (1) Nighthawk System Box
- (1) I/O Board Assembly Silver Strike X
- (1) Cabinet Identification Device (CID) for Silver Strike X
- (1) Control Panel Graphics Overlay, Silver Strike X
- (1) Marquee, Silver Strike X
- (1) Silver Strike X.com Logo Card
- (1) Side Decal, Silver Strike X
- (1) 3" Trackball Assy, White
- (1) 3" Trackball Plate
- (1) Cable Bag Sub-Assembly
- (1) Parts Bag Sub-Assembly
- (1) HDMI cable, 15 Ft.
- (1) Card Reader Blanking Plate
- (1) Quick Install Guide
- (1) Manual, Silver Strike X
- (1) Input/Output Connections Cable

KIT INSTALLATION

RECOMMENDED TOOLS

Have the following tools ready before you begin to install this kit:

- ¼", 11/32" and 7/16" Sockets or Nut Drivers
- Phillips Head #2 Screw Driver
- 3/16", 7/32" and 9/32", or 5/16", 3/8", and ¾" Drill Bits
- 1 1/8" and 3 1/2" Hole Saw or Drill Bit
- Small Flat Blade Screwdriver
- Jig/Sabre Saw
- Router
- Push Button Nut Socket or Large Adjustable Pliers
- X-acto® Knife or other Sharp Knife/Razor Blade
- Wire Cutters
- Scissors
- Tape Measure
- Putty Knife
- Decal Roller/Squeegee
- Liquid Window Cleaner & Cleaning Cloth
- Vacuum Cleaner
- Any tools needed to remove parts from your existing cabinet not listed above.

Many operators notice their earnings increase with touches as simple as a fresh coat of paint and a clean cabinet.

If you will be painting, you'll need these supplies:

- Air Brush or Paint Sprayer
- Paint Brush, Paint Roller, and Pan
- Paint (and Primer) --**We recommend black as a cabinet color choice.**
- Sandpaper

INSTALLATION PREPARATION

BEFORE YOU START...

Before you install the Silver Strike X kit into your cabinet there are a few things you should check first:

1. Check to make sure your existing cabinet's monitor, speakers, AC power cord, lights, bill acceptor and coin mechanisms work.
 - Replace or repair where necessary.
2. Check to make sure all the necessary parts are included in your kit.
 - If any are missing/damaged please contact IT's Technical Support (see last page of this manual for number).

3. Check to make sure cabinet is wired with standard earth grounded AC plug compatible with local building codes and/or safety requirements.
 - ❑ If not, have a qualified electrician install one (not provided).
4. Have all the necessary tools available to install this kit.
 - ❑ Refer to the recommended tools list to make sure you are prepared before you start.
5. Make sure any parts of the system (lights, monitor, etc.) are not plugged in.
 - ❑ Working with any part of the system plugged in or powered on can be dangerous.
6. Keep in mind that it's been proven that the higher quality of work put into a kit installation results in a higher earning game.
 - ❑ Make sure you have plenty of space, time, and focus to put into this kit installation.

PREPARING THE CABINET

CABINET SELECTION

You can choose either a new cabinet or a used cabinet for your Silver Strike X game. Reusing a cabinet is by far the most cost-effective way to maximize the return on your initial investment. In either case, you will need: A working cabinet, speakers and a HDTV capable of at least 720p resolution.

Note: For the high definition video application see HDTV section.

Due to the HDTV monitor requirement it is not possible to use an older dedicated cabinet with Silver Strike X unless it has been repurposed. The Showpiece cabinet, or other repurposed cabinet, are the only cabinets that works with this version of Silver Strike X.

PREPARING THE CABINET FOR INSTALLATION

Follow these steps to prepare your cabinet before installation:

1. Remove the following from the cabinet: Main Logic Board(s) (and hard drive if present), Control Panel, Monitor Viewing Glass, Marquee, Power Supply and JAMMA Cable Harness. The I/O Board in this kit does **not** have a JAMMA connector but instead uses an Input/Output Connections Cable. Now is a great time to clean both sides of the monitor viewing glass and monitor screen to ensure a clear viewing area.
2. Thoroughly clean out your cabinet. Remove all of the old buttons, wiring to buttons, joysticks, coin switches and meters. Replace wiring from the I/O Board with the Input/Output Connections Cable.
3. Remove the old graphics and adhesive from the cabinet including the control panel.
4. For a fresh look and best earnings, painting is highly recommended. Spray painting gives a better finish, but if an air brush or paint sprayer is unavailable a roller is second best. Remember to cover all exposed surfaces not to be painted.
5. Make sure to have the sides of the cabinet and the control panel as smooth and flat as possible to allow for a higher quality finish when applying the control panel background, labels, and side decals.
6. The "new game look" should always apply to the inside of your game as well. A few wire ties and shrink tubing on your harness, some fastening hardware on your subassemblies, and a sweep with the vacuum cleaner will help ensure that glitches do not occur.

CHECK HARNESS AND WIRING

The Silver Strike X Kit can easily interface with other IT cabinets. If your current cabinet is equipped with a standard JAMMA cable, the JAMMA cable assembly will need to be removed and replaced with the Input/Output Connections Cable included with the kit. Make sure your existing wires and connectors are in good working order. Check the pin out chart in Appendix B and the wiring diagram in Appendix D for harness connections.

CHECK COIN MECHANISMS AND BILL ACCEPTOR

Make sure your coin mechanisms and bill acceptor are functioning properly, and your coin box and stacker are in good condition. You want to make sure your game will accept money when players are ready to play.

CHECK COIN DOOR CONNECTIONS

Your cabinet should already be wired correctly to the I/O Board's connectors. Now is a good time to make sure your game can accept money. Check the pinout chart in Appendix B for the correct wire colors and pins. Trace the wiring to their sources and make sure they are connected properly and securely. Be sure the wires are away from the coin door where they can be pinched or crimped.

CHECK HIGH-DEFINITION TELEVISION

Silver Strike X supports a 720p resolution that is compatible with newer flat-panel LCD digital televisions. Televisions with lower resolutions are NOT supported. Refer to the Showpiece section of this manual for details on connecting video and audio to a 720p HDTV.

Note: Video and audio connections to these displays vary, and may require additional cables not included in the Silver Strike X kit. In addition, some televisions may not support the resolution needed for Silver Strike X. Check your television's manual for additional information.

WARNING: Be sure top of cabinet has at least 24 inches or 61 centimeters of clearance in all directions. Insufficient clearance may result in damage to monitor or player injury.

REMOVE CABINET GRAPHICS

Remove any decals from the cabinet. Make sure that the sides of the cabinet are as smooth and flat as possible to allow for a higher quality finish.

REMOVE EXISTING CARD READER (IF APPLICABLE)

If you are using an older cabinet, the existing card reader must be removed. To remove your current card reader, open the coin door to access the card reader. Reach inside and disconnect the ribbon cable from the Card Reader. Then from inside remove the four 11/32" nuts that hold the card reader to the inside of the cabinet. Once loose, pull the card reader out through the front of the cabinet. If you are installing an Offline kit, install the supplied card reader plate to cover this opening.

VACUUM CABINET

The "new game look" should always apply to the inside of your game as well. A few wire ties and shrink tubing on your harness, some fastening hardware on your subassemblies, and a thorough sweep with the vacuum cleaner will help ensure that glitches do not occur.

Dust and dirt can damage your hardware and cause problems with game play. Be sure that your cabinet is clean inside and out. It is highly recommended to vacuum your cabinet at least once a month, especially near the fans and vents, to avoid overheating and costly repairs.

ELECTRONICS INSTALLATION

INSTALL NIGHTHAWK SYSTEM BOX

The Nighthawk System Box houses most of the game electronics and hardware into one box that can be easily installed. **Verify that the Nighthawk System Box Power Switch is in the "ON" position.**

1. Locate the area where the system box will be placed. Make sure there is enough clearance to plug in cables. In newer Showpiece cabinets the area is directly below the control panel.
 - The Nighthawk System Box measures 19" W x 7" H x 11" D. Allow for air to flow into the system box through the filter. Overheating can damage your system.
2. Relocate and secure any wires to make room for the system box.
3. Place the system box so it does not pinch wires.
4. Mount the system box with 6 - #6 x 3/4" Hex Washer Head Sheet Metal Screws.

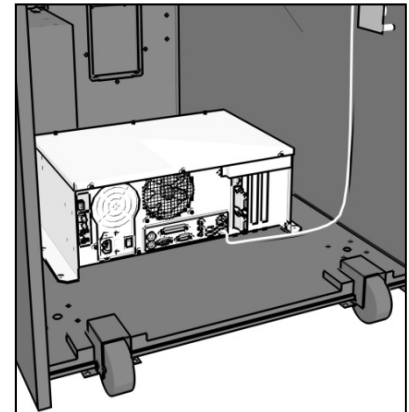

Note: The Nighthawk System Box comes equipped with an external air filter to help keep dust, smoke and debris from collecting on the electronic components. Check and clean this filter regularly to avoid costly repairs.

INSTALL CABINET IDENTIFICATION DEVICE (CID)

The Cabinet Identification Device or C.I.D. is an innovative and important component. This device permanently identifies your cabinet as Silver Strike X. It should remain even if another component such as the I/O Board or system box is replaced. The C.I.D. has a unique number to individualize the cabinet and is referred to as the Cabinet Identification Number.

1. Attach the C.I.D. to the inside side of the cabinet using the 2 - #6 X 1" Hex Washer Head Sheet Metal Screws. Mount so the port is facing up and the electronics face the wall.
2. Attach the USB cable from the system box.
 - Place the included Cabinet Identification Number on the back of the cabinet for future reference. **Refer to this number to track your equipment and whenever you are calling in for service.**

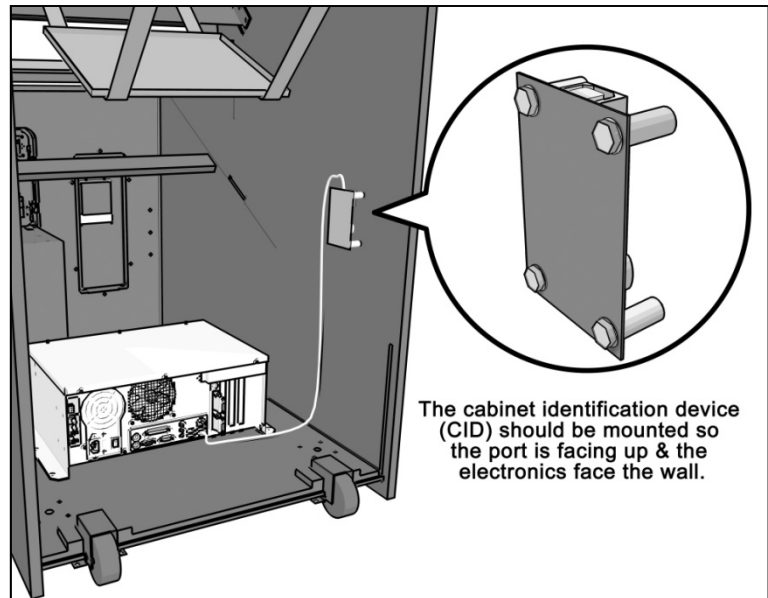

The cabinet identification device (CID) should be mounted so the port is facing up & the electronics face the wall.

Disconnect all CID USB cables before transport.

- The Cabinet Identification Number is displayed in the operator menus in the lower right hand corner, and is labeled as Game ID. It is also displayed on the last line of the initial boot-up screen.

INSTALL I/O BOARD

BEFORE INSTALLING ANY ELECTRONICS, MAKE SURE CABINET POWER SWITCH IS IN THE OFF POSITION AND THE CABINET POWER IS UNPLUGGED FROM THE WALL.

The I/O Board is used as a connection interface between the peripherals and the system box.

Mount the I/O Board inside the cabinet using 4 of the 6 x 3/4" Hex Washer Head Sheet Metal Screws, one in each corner. Do not attach cables at this time.

Route all cables AWAY from the I/O Board. Laying cables on top of or below the I/O Board will result in unwanted noise or static during game.

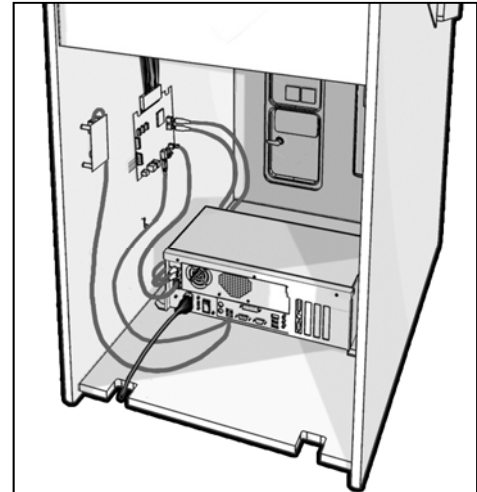

Disconnect all I/O Board USB cables before transport.

TRACKBALL AND BUTTON PREPARATION (FOR MOST KITS)

Mounting the trackball and buttons correctly and securely is very important for the profitability and safety of your new game. This kit is designed for use in cabinets with 3/4" thick wood control panels where proper routing of the control panel is used to create a safe playing experience. If you do not have a 3/4" thick wood control panel, please replace your control panel or choose a cabinet with a 3/4" thick wood control panel installed. Keep in mind that if your current control panel has many old holes in it from previous buttons, joysticks, etc. that it may be easier to start with a new solid control panel. This will give your game a better look and feel and help it to earn better.

If the cabinet already has a trackball plate installed, discard and replace with the new trackball plate. The metal trackball mounting plate and trackball mounting procedure have been designed to remove all bolts from the playing surface. Routing the wood control panel is required so the metal mounting plate is flush with the panel surface. An uneven playing surface or exposed edges will affect game play and could impact your earnings.

TIP: Trackball and button templates can be found in Appendix G of this manual. They include:

- Trackball Orientation Diagram to orient your trackball correctly when installing.
- Trackball Template to install the trackball plate and make the appropriate routing.
- Button Set Templates to position and install control panel buttons.

Trackball Preparation

Install the metal trackball plate by following these steps:

1. Cut out the template from Appendix G with a pair of scissors along the noted line. Tape this template to the top of the control panel as far away from the monitor as possible, making sure that the trackball will clear the cabinet beneath it. Remember that installing the trackball as far away from the monitor as possible will prevent players' hands from hitting the monitor glass when rolling the trackball forward.
2. Using a sharp object, mark the eight points shown on the template on the control panel. Using a pencil, trace the outside of the template. Remove the template.
3. Drill Holes 1-4 with a 9/32" or 5/16" drill bit.
4. Drill Holes 5-8 with a 3/4" drill bit.
5. Route the crosshatched region to a depth of about .075" (about the thickness of a nickel).
6. Using a sabre saw cut out the center portion by cutting between holes 5-8.
7. Once you have cleaned up the routed area, install the trackball plate into the control panel using the 1/4" Flat Washers and 1/4-20 Nylon Hex Nuts. Be sure the mounting plate is flush with the top of the control panel.

Note: At this time you are only installing the trackball plate, do not install the trackball yet.

Button Preparation

The following are the steps you should take to prepare your control panel for the installation of the button assemblies:

1. Cut out the template(s) (see Appendix G).
2. Using a tape measure, measure the specified distances from the center of the trackball hole in the trackball plate and make a mark for both the left and right button reference points.
3. Lay each template over the appropriate reference marking point. Mark the centers of the remaining holes using a sharp object.
4. Drill a 1 1/8" hole at each marked point.

CAUTION: Do NOT install the trackball or buttons until the control panel graphics have been applied.

Once the installation is complete, be sure to use the Player Control test in the game's System Setup menus to ensure proper functionality of all the player controls.

CONTROL PANEL OVERLAY INSTALLATION

Silver Strike X comes with an oversized control panel overlay that will accommodate a variety of existing game cabinets. Follow these instructions to correctly install the control panel overlay on one of these cabinets:

1. Make sure that the newly drilled control panel has a smooth, clean surface. Sand where necessary to make sure the graphics are installed on an even surface.
2. Clean the control panel to make sure it is free from dust, grease, metal filings, etc. Make sure that all residues (adhesive, overlay material, etc.) from the previous control panel graphics are removed. This will ensure a clean, easy, and beautiful application of the control panel graphics.
3. **It is very important that the trackball and control panel graphics be mounted perfectly straight.** Find the center of your trackball template and lightly draw vertical and horizontal guidelines on the control panel, marking out your centering lines.
4. Remove a small section of the protective backing from the overlay. Carefully center the overlay over the control panel by lining up the die-cut hole with the trackball template. **Be sure the graphic is positioned perfectly straight.** Line up your pencil guidelines with the lines incorporated into the art. Once in position, gently press down on the section with exposed adhesive, affixing the overlay into place. Once affixed, the overlay cannot be removed.
5. While holding down the overlay over the attached area, very carefully turn over one side and remove the exposed backing. Gently lay down the exposed overlay from the center outward, smoothing with your hands or a roller as you go. **Be sure the overlay remains straight and square.** Repeat the process with the other side of the overlay, so the entire surface is affixed to the control panel. Make sure all bubbles have been pressed out for a clean, flat surface.

TIP: Liquid window cleaner can be sprayed onto the control panel before placing the overlay onto the control panel. The window cleaner will allow the overlay to be positioned with less risk of damage to the overlay or adhesive. Once in position, use a decal roller or squeegee to force any excess cleaner out. Be sure to add additional time for the liquid to evaporate.

6. Using a razor knife (or other sharp instrument) carefully cut around the edges of your control panel, trimming any excess material.
7. Find the center of each hole you have drilled out for the buttons and use the knife to poke a hole into the overlay. Make a vertical and horizontal line (like a plus sign) from the center of the hole to the edges. You should be able to place your button in later with no edges showing.

CAUTION: If you choose to install a Plexiglas® cover over your control panel (not recommended), to ensure the safety of your players and the quality of your game make sure that all surfaces, edges and bolts that a player may come in contact with are smooth, safe and secure.

FINISHING THE CONTROL PANEL

1. Reattach the control panel to your cabinet adjusting any hinges or chains where necessary. Make sure not to pinch or crimp any wires while re-attaching the control panel.
2. Install the trackball into the trackball plate. The trackball must be oriented correctly in order to function properly. Refer to the diagram located in Appendix G for correct orientation. You will need the following parts in order to install the trackball correctly to the plate: 4 - 10/32 x 2½" Phillips Head Machine Screws, 4 - #10 Flat Washers and 4 - #10 Split Lock Washers **NOTE:** Do not over-tighten the trackball. It will warp and cause the trackball to fail.

IMPORTANT! Be sure to securely install your trackball and regularly maintain it. Loose, worn, or incorrectly mounted trackballs can result in decreased earnings and possible injury to players.

3. Secure the trackball ground wire to the trackball plate at the 8-32 stud on one end with an 8-32 KEPS nut and the other end to the cabinet ground stud (usually located near the AC power cord inlet) using an 8-32 KEPS nut.
4. Install the buttons in the holes located on your control panel. Make sure you use the red button assembly for the Start button and white buttons for Left, Right and Overview.
5. Attach the micro switches to your newly installed buttons and connect the wires up to the correct pins on the Input/Output Connections Cable.

Note: The post on the switch labeled COM should connect to the ground wire and the post labeled NO should connect to the signal wire. See the pin out chart in Appendix B.



CAUTION: Trackball and trackball plate **MUST BE GROUNDED** to Earth Ground to prevent damage to the trackball or game electronics.

COMPLETE SYSTEM BOX CONNECTIONS

Follow these procedures to correctly connect the various electronic components. Be sure the cables are connected securely and in working order. Use cable clamps, with appropriate tension, where necessary to ensure all cables stay in place during operation. Dress all cables with additional clamps and wire tie wraps where needed. Avoid loose wires or disconnected cables, as they can cause an unneeded service call.

ATTACH I/O POWER, AUDIO AND USB CABLES

- ◆ **I/O Board power cable.** Connect from the I/O Board to one of the two 4-pin power output connectors on the system box.
- ◆ **Audio cables (optional).** Connect to the audio output jacks of the system box. Match the appropriate colors.
- ◆ **USB cable #1.** Connect from the I/O Board to any USB port on the system box.
- ◆ **USB cable #2** for Cabinet Identification Device (CID). Attach to any USB port on the system box. Refer to the CID Installation Section for proper orientation and placement of the CID.

ATTACH MAIN VIDEO CABLE

Connect the HDMI cable from the HDMI port on the HDTV to the HDMI port on the back of the Nighthawk System Box. If your cabinet has a SVGA monitor, connect the VGA cable to the DVI/VGA adapter on the back of the Nighthawk System Box directly to the SVGA monitor input.

Be sure to adjust your DIP Switch settings to match your monitor's resolution. Refer to Appendix D. If using a HDTV connection, see the Showpiece Cabinet HDTV section.

ATTACH POWER CABLE

Use the AC power cord that is currently in your cabinet. The cord plugs into the system box. Have a qualified electrician do the wiring. Verify AC main voltage selector switch is in the proper position. In North America the setting is 115 volts AC. In some countries this should be set at 230 VAC.

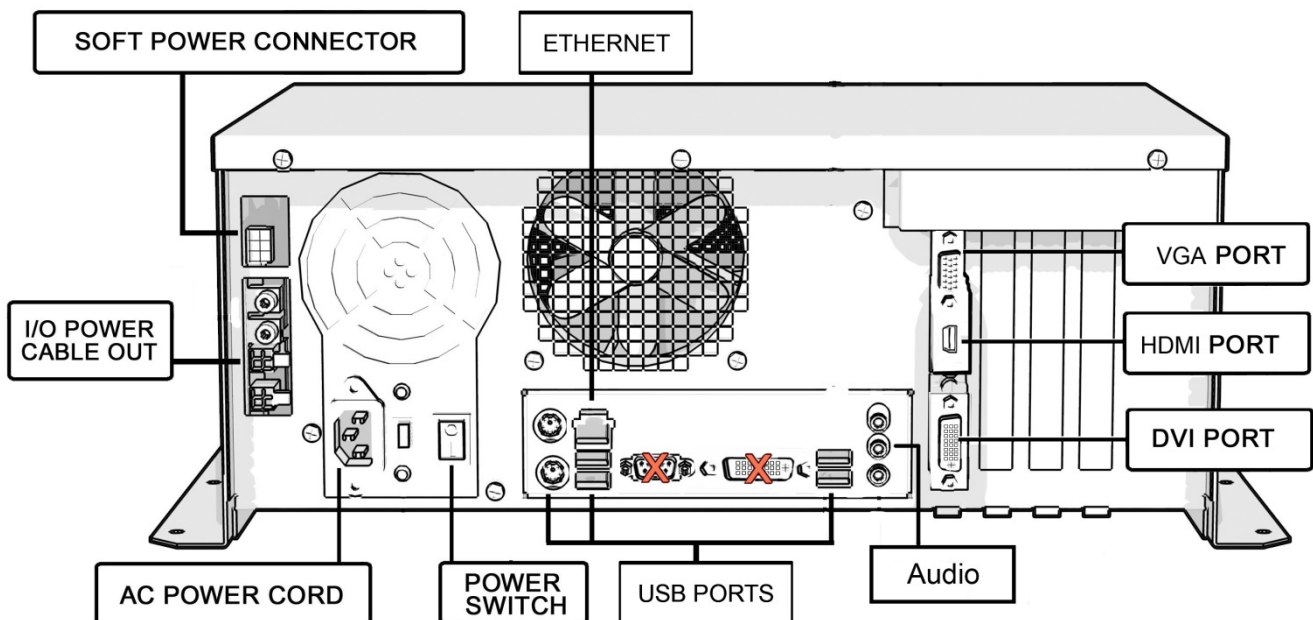

COMPLETE I/O BOARD CONNECTIONS

CONNECT INPUT/OUTPUT CONNECTION CABLE TO I/O BOARD

Connect the Input/Output Connection Cable to the I/O Board connectors (Appendix B). Be sure it has a tight fit and is correctly oriented. The size of the connectors should match the size of the connectors on the cable.

Note: The Speaker (J301) wires and service panel wires must terminate to match your application.

CONNECT THE CONTROL PANEL SWITCHES AND CABLE

Snap the switches onto the buttons. Connect the Control Panel wiring harness using the pin out chart in Appendix B.

CONNECT COIN DOOR LAMPS

Connect the coin door lamp cable to the pigtail off the I/O Power cable. If your game had a GT Fore! green PCB, then use the 9 pin connector. If your game had a GT Fore! red PCB, then use the 4 pin connector. Find the mating connector leading to the coin door to make your connection.

CONNECT THE TRACKBALL

Locate the Trackball Cable and connect it to the connector labeled Trackball on the I/O Board. The other end will connect to the trackball. Connect the green earth ground wire to the trackball plate.

CONNECT THE USB CABLE

Locate the 6 ft. USB Cable on the Nighthawk System Box and connect it to the USB port on the I/O Board and the Cabinet Identification Device (CID).

CONNECT HIGH-DEFINITION TELEVISION

The HDTV must have a resolution of 1280x720 (HDMI) to support Silver Strike X. The HDTV display can be connected to the system box using HDMI to HDMI, DVI to VGA and DVI to HDMI connections. Refer to the diagrams in Appendix D for the proper connection for your television. Be sure to set the Video DIP Switches on the I/O Board to match your resolution.

CONNECT I/O POWER CABLE

Connect the I/O Power cable to the power input connector. Use the end with the pigtail. The other end connects to the system box.

CHECK ALL CONNECTIONS

Go over your entire cabinet again and double-check all of the connections. Make sure that all connectors are tight and secure and in their proper place. Look for frayed, broken or exposed wiring and repair as needed. Bundle and wire-tie your wiring and secure it to the inside of the cabinet. A thorough and neat job now will save you a lot of time and trouble in the future.

CABINET MARQUEE INSTALLATION

Included with your Silver Strike X kit is a new marquee. This will help identify your new game as Silver Strike X. By placing and installing it correctly it can help give players instant recognition, even from a distance.



Showpiece Marquee Installation

1. Slide the rectangular marquee mounting frame from its position on the two upright posts.
2. Remove any one of the four side pieces of the mounting frame.
3. Remove the current plastic laminate marquee from the mounting frame, but do not remove the cardboard.
4. Slide the updated marquee into place and reassemble the side piece or pieces. Make sure all of the surrounding pieces of the mounting frame are tight and the plastic laminate is smooth against the cardboard.
5. Slide the fully assembled marquee back into position.

FINAL CONNECTIONS

COIN DOORS, TEST SWITCH AND VOLUME CONTROL

Wire the coin doors as per the Input/Output Connections table in Appendix B. Connect the door lamps to the appropriate (+12Vdc or +5Vdc) supply. Some games have separate power supply outputs for the lamps. Install a test switch somewhere convenient inside the coin door area. This switch allows you to enter System Setup Menus, run diagnostics, and see or clear audits. Make it readily accessible through the coin door. Silver Strike X has the ability to adjust volume at any time during a game. Install two push button switches (not included) inside the coin door for easy access. Connect the switches to the appropriate connections. Refer to the Input/Output Connections table in Appendix B.

INITIAL POWER-UP

There are several steps you should take when powering up your Silver Strike X for the first time. This is a quick checklist for you to follow when doing your first initial power-up:

- ❑ Plug in the game and turn it ON; be sure the game powers up correctly into the attract mode.
- ❑ Adjust volume levels to desired settings.
- ❑ Adjust monitor settings for best picture.
Note: Sound and Video Tests are available through the System Tests Menu. They are beneficial when making any adjustments. Proper monitor and sound adjustment is very important.
- ❑ Try all money slots. Drop quarters or tokens through to check the coin mechanisms and insert a bill into the bill acceptor. Make sure the game is adding credits.
Note: Silver Strike X supports most bill acceptors. Installing a bill acceptor is highly recommended and will increase your earnings. Refer to your bill acceptor's manual for installation specifications. The bill acceptor can be wired to J205 Pin 5 on the I/O Board.
- ❑ Test all of the player input controls. You can use the PLAYER CONTROL TESTS in the SYSTEM SETUP MENU.
- ❑ Upon initial power-up the game is set to factory default settings. These settings affect game elements such as number of credits per coin, difficulty settings, etc. The OPERATOR MENUS section will describe how to alter these settings for your location.

Congratulations! You have finished installing Silver Strike X!

SILVER STRIKE X SYSTEM SETUP MENUS

SYSTEM SETUP MENUS

Navigating the Menu System

The System Setup menus cover a variety of important areas including collections, tests, game adjustments, and optional settings. You should familiarize yourself with these menus, as they are designed to optimize your game for your location and your business. Pay particular attention to the Collection menus, as they will detail how much money to give to your location. There are also menus that allow you to adjust various split percentages for a variety of different charges. These screens can help you maximize your investment and involve your location in the costs associated with your equipment.

Entering System Setup Mode

There are two ways to enter System Setup. Open the coin door and press the Test button to access the game's System Setup software menu system. Or, from the I/O board, move the dip switch Sw202 position 4 to the ON position. This switch needs to be moved back to OFF to exit the System Setup menus.

Selecting a Menu

A menu option can be selected at any time by rolling the trackball up or down or by pressing the Left or Right buttons.

Choosing a Menu/Option

A menu option can be chosen at any time by pressing the Start Button.

Changing a Value

A value can be changed at any time by rolling the trackball left or right.

MAIN MENU

The Main Menu displays five main areas that make up System Setup mode. Please familiarize yourself with these areas, as they will help you maximize your earnings potential.

Collections & Earnings (Page 25)

This section displays your machine's monetary activity, and details the various areas for income and expenses. This section should be reviewed during every collection, to make sure you manage your split correctly.

General Settings (Page 26)

This area allows you to change operator adjustables, perform system tests, and reset your game back to factory settings.

Troubleshooting Shortcuts (Page 36)

This section presents a variety of tests and menus that will help you troubleshoot any problems you may be having with your game. The available sections are also accessible through the other main sections.

Silver Strike Settings (Page 36)

This area allows you to adjust settings specific to Silver Strike X including the player cost schedule, game features, and game audits.

Note: Always **Exit** out to the attract mode when making changes to menu configurations or settings to save changes. If the cabinet is shut down while operator adjustable settings menus are still open, the changes will not be saved.

Exit

This will exit the System Setup menus and take you back into the game's attract mode.



COLLECTIONS & EARNINGS MENU

This menu allows you to perform a collection or view various earnings and fees. For detailed samples and collection tools, see the Collections Guide at the back of this manual.

Do Collection

This section is used when making a collection. The various screens will detail the cost breakdowns and show you how much of the cash box is to be paid to the location. Please take some time to familiarize yourself with this section. Using it wisely can save you money.

Clear Unused Cash

Sometimes when you go to make your collection, there is money in the game that has not been played yet. Use this setting to clear the unused cash from the game, so your future collections will reconcile with game play.

Add Free Cash

Use this setting if you wish to add money to the game for free plays that do not advance the hard meter.

Back

This will take you back to the **Main Menu**.



DO COLLECTION

This screen is the main collection screen. There is a lot of useful information displayed to help with your collection. It is highly recommended that you view this screen with every collection, and reset it when the collection is complete.

This screen displays the following helpful information:

Collection From:

The displayed dates are from your last collection until today.

Days In Operation

The number of days the machine was active and available for play since the last collection.

Reset (Across from Days in Operation)

Highlight this to reset the number of days in operation field to '0'.

Total Income

The total income your machine made for this time period.

More Details (Details for Total Income)

Select More Details to open the *Total Income* menu, which details income from Cash, Player Accounts and various promotional or Gift Cards.

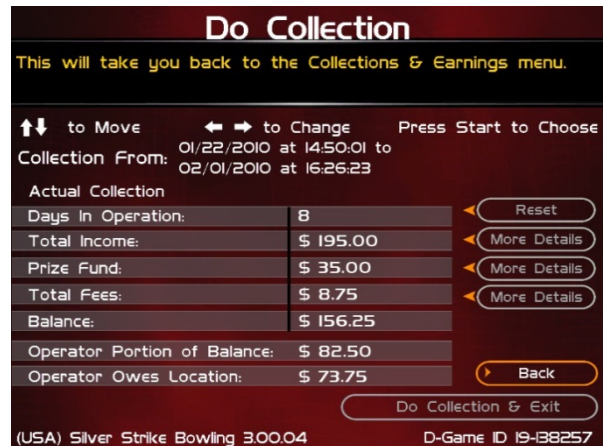

Prize Fund

Split between operator and location, and 100% of this fund is redistributed back to the player.

More Details (Details for Prize Fund)

Select More Details to open the *Collection Fee/Funds Details* menu indicating the actual fee splits for the operator and the location.

Total Fees

The total of the various fees that need to be set aside before making your split.

More Details (Details for Total Fees)

Select More Details to see the *Collection Fees* menu, which has a breakdown of various fees, including the ITNet fees (not applicable to offline games), Communication fees, Software Update fees, Hardware Upgrade fees and Taxes.

Note: *Hardware Upgrade and Software Update Fees are included for your convenience.*

Balance

The total income minus the total fees.

Operator Portion of Balance

The amount of the collection that the operator keeps.

Operator Owes Location

The amount of the collection that you pay your location.

Back

If you do NOT wish to perform a collection and reset the audits, highlight Back to exit this screen and return to the **Collections & Earnings** menu.

Do Collection and Exit

To perform a collection and reset the audits (recommended), highlight Do Collection and Exit and press Start. This will set all the fields in the Do Collection screen to zero. Be sure to empty your cash box at the same time, so these screens will match the money at your next collection.

GENERAL SETTINGS

The General Settings menu houses various adjustable settings relating to the cabinet, and is divided into three sections.

Operator Adjustables

This area allows you to adjust options like volume, attract mode sounds, and money slot settings.

System Tests

This area allows you to perform diagnostics including video adjustments, input tests, and sound tests.

Advertisements

This area allows you to manage various graphic and text advertisements on your machine. This section is currently unavailable but is planned for a future update.

Back

This will take you back to the **Main Menu**.

	Operator Portion	Location Portion	Total
ITNET Fees:	\$ 0.03	\$ 0.02	\$ 0.05
Prize Fund:	\$ 0.00	\$ 0.00	\$ 0.00
Communication Fee:	\$ 0.00	\$ 0.00	\$ 0.00
Software Update Fee:	\$ 0.00	\$ 0.00	\$ 0.00
Hardware Upgrade Fee:	\$ 0.00	\$ 0.00	\$ 0.00
Taxes:	\$ 0.00	\$ 0.00	\$ 0.00
TOTALS:	\$ 0.03	\$ 0.02	\$ 0.05
Operator Remits	\$ 0.05	To Incredible Technologies	
Operator Remits	\$ 0.00	To Tax Authorities	
Location Remits	\$ 0.00	To Tax Authorities	

ITNET Fees:	\$ 12.95
Communication Fees:	\$ 109.63
Software Update:	\$ 0.00
Hardware Upgrade Fee:	\$ 0.00
Taxes:	\$ 0.00
Operator Remits:	\$ 124.58
Location Remits:	\$ 0.00



OPERATOR ADJUSTABLES

This menu contains adjustable settings that pertain to you and your business. Please familiarize yourself with this section to help you maximize the game's earning potential.

General Adjustments

This area allows you to adjust options like coin message, game mode and monitor mode.

Money Slot Adjustments

This area allows you to adjust the settings of your various money slots on your cabinet.

Sound Adjustments

This area allows you to adjust the various sound settings including attract mode sounds, game volume, and stereo setup.

Collection Settings

This important area allows you to adjust splits and view various fees for your collections.

Reset To Factory Settings

This option allows you to reset all the settings found in the Operator Adjustables section to factory defaults.

Back

This will take you back to the **General Settings** menu.



GENERAL ADJUSTMENTS

Coin Message

Is set to "Insert \$" by default and requires the player to insert money. No other modes are available.

Game Mode

This lets you toggle between money/free play. **The default is set to Money Play.**

2nd Monitor Mode

You can connect a second monitor to the extra video connector on the system box, which is great for promotions or special events. Ensure the Current Value is set VGA.

Reset Values

This resets all values to their default value located on this page.

Back

This will take you back to the **Operator Adjustables** menu.



MONEY SLOT ADJUSTMENTS

Money Slot 1

This adjusts how much one pulse equals for Money Slot 1. **The default is set to \$0.25.**

Money Slot 2

This adjusts how much one pulse equals for Money Slot 2. **The default is set to \$0.25.**

Money Slot 3

This adjusts how much one pulse equals for Money Slot 3. **The default is set to \$0.25.**

Reset Values

This resets all values to their default value located on this page.

No

This will not perform the reset and take you back to the previous menu.

Yes

This will perform the reset and take you back to the previous menu.

Back

This will take you back to the **Operator Adjustables** menu.



SOUND ADJUSTMENTS

In Game Volume

This option lets you adjust the In Game volume from OFF to 100%. When routing audio through the television, the Game Volume Setting needs to be adjusted up to 75%. Then use the television volume control as the Master Volume. **The default is set to 30%.**

Attract Volume

This option lets you adjust the Attract Volume from OFF to 100%. **The default is set to 20%.**

Attract Mode Sounds

This adjusts how often sounds are played in the attract mode: Never, Rarely (every 20th time), Sometimes (every 10th time), Often (every 5th time), and Always. **The default is set to On - Sometimes.**

Stereo/Mono

This option is where you select stereo or mono setup. **The default is set to Stereo.**

Reset Values

This resets all values to their default value located on this page.

Back

This will take you back to the **Operator Adjustables** menu.



COLLECTION SETTINGS

Silver Strike X allows you to adjust costs and percentages for the various income types that are received, as well as fees. Use this menu to determine how much you want your location to help you pay for these charges and services.

Set Hardware Upgrade Fee

This menu allows you to adjust the Hardware Upgrade Fee. This fee is included for your convenience, as a method to have the location pay for part of your equipment. **The default value is \$0.00 per week.**

Note: *Hardware Upgrade and Software Update Fees are included for your convenience.*

Operator/Location Income Splits

Use this menu to fine-tune your splits for any generated income. Since there may be times when you have to pay the location before you actually have the cash in hand, you may want to adjust the split in your favor to cover the waiting period. The default settings are displayed on the accompanying screen.

The adjustable settings refer to income generated from:

Cash

Player Account (N/A for offline games)

ITNet Money Card (N/A for offline games)

Operator Money Card (N/A for offline games)

Operator/Location Fee Splits

Use this menu to determine how you wish to split the various fees with your location. For example, since there is a fee associated with ITNet, you may want to adjust the split in your favor to help cover the costs.

ITNet Fees (N/A for offline games)

Prize Fund Fees (N/A for offline games)

Communication Fees (N/A for offline games)

Software Update Fees

Hardware Upgrade Fees



Tax Settings

Many states require special taxes or license fees that affect your bottom line. Use this menu to separate these costs from your collection before making your normal split.

Set Tax Rate

This menu allows you to adjust your current tax rate percentage.

Set Tax Type

This menu helps you determine what part of the collection is taxed, and who pays for these taxes.

Set Tax Split

This menu allows you to split the tax fees with the location.

Back

This will take you back to the **Collection Settings** menu.

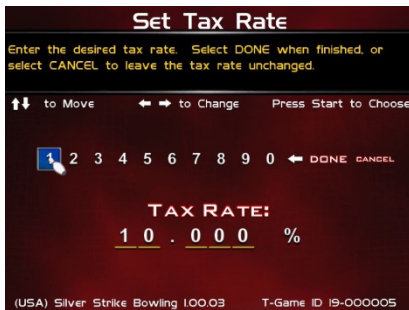
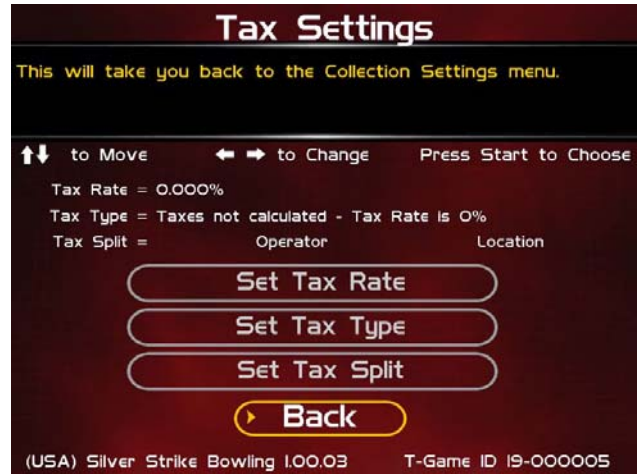

Reset to Defaults

This menu will set all of the collection settings to their factory default values. A verification screen will display to make sure you agree to the change.

RESET TO FACTORY SETTINGS

This menu will reset ALL settings in the Operator Adjustments section to their default values. A verification screen will display to make sure you agree to the change.



SYSTEM TESTS

This area allows you to perform diagnostics including video adjustments, input tests, and sound tests.

Video Tests

This area has tests that will help you to adjust your game's color, contrast, and screen size.

Sound Tests

This area has tests that will help you adjust your game's audio setup by playing a stored sound, a streaming sound, and testing the speaker(s).

Player Control Tests

This option allows you to test all inputs including trackball, buttons, money slots and card reader.

Mechanical Meter Test

This test makes the hard meter adjust by one to make sure it is functioning properly.

Hardware Tests

This area includes a series of diagnostic screens and tests to help you make sure your game is functioning correctly.

Back

This will take you back to the **General Settings** menu.



VIDEO TESTS

The Video Tests section has a variety of tests that will help you adjust your monitor.

Color Adjustments

This area will take you to a series of tests to adjust your monitor's RGB settings to have each color display properly.

Contrast Adjustments

This area will take you to a series of tests to adjust your monitor's brightness/contrast so the game displays properly.

Screen Size Adjustment

Use this screen to align your monitor so that all the circles appear as circles and the boundary line appears on the edge of each side of the screen.

Back

This will take you back to the **System Tests** menu.



COLOR ADJUSTMENTS

Color Grid Adjustment

Adjust your monitor to have each colored box display properly.

Red Screen

Adjust your monitor to have red display properly.

Green Screen

Adjust your monitor to have green display properly.

Blue Screen

Adjust your monitor to have blue display properly.

Back

This will take you back to the **Video Tests** menu.



CONTRAST ADJUSTMENTS

White Screen

Adjust your monitor to have white display properly.

50% White Screen

Adjust your monitor to have 50% white display properly.

25% White Screen

Adjust your monitor to have 25% white display properly.

Black Screen

Adjust your monitor to have black display properly.

Contrast Screen

This option is a test you can use to adjust your monitor's contrast and brightness settings to have the boxes displayed properly.



Note: May not work on older or often used monitors. If you have a monitor that's old or has been used often you may not be able to adjust the contrast and/or brightness levels accordingly. In this case adjust the monitor for best performance while getting close to the recommended settings.

Back

This will take you back to the **Video Tests** menu.

SCREEN SIZE ADJUSTMENT

Use this screen to adjust the size and aspect ratio of your picture. Press the Start button to exit.

If you are using an HDTV display, you may need to adjust this screen to see the complete image. Use the trackball to highlight **Bigger** or **Smaller** and press the Start button to adjust the screen image. (Only available in 800x600 and 1280x720 resolutions.) Press **Done** to exit.

Note: Adjusting the screen size will prompt a reboot upon exit of this menu.



SOUND TESTS

Stored Sound

This will play a stored sound so you can make sure your audio setup is functioning properly.

Streaming Sound

This will play a streaming sound so you can make sure your audio setup is functioning properly.

Speaker Test

This test will say MONO if you have your game set to Mono or LEFT and RIGHT if you have it set to stereo so you can make sure your audio setup is functioning properly.

Back

This will take you back to the **System Tests** menu.



PLAYER CONTROL TESTS

Use this screen to test all of the inputs, including the trackball, buttons, money slots and card reader. When an input is active the appropriate graphic image will light. Press the Left, Right and Start buttons simultaneously to exit this test screen.

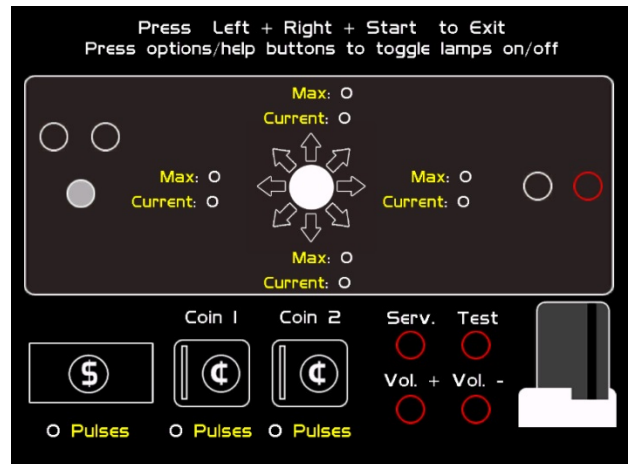

MECHANICAL METER TEST

Click Meter

This test makes the hard meter adjust by one to make sure it is functioning properly.

Back

This will take you back to the **System Tests** menu.



HARDWARE TESTS

This area includes a series of diagnostic screens and tests to help you make sure your game is functioning correctly.

Hardware/Software

This area has options to view your system and USB info.

Check Hard Drive

This test checks the integrity of your hard drive's data.

Note: This test can take several minutes.

Check Cooling

This test helps you make sure your game is functioning at the proper temperature and all fans are working.

Check Card Reader

Not available for offline games.

Back

This will take you back to the **System Tests** menu.



HARDWARE/SOFTWARE

System Info

This is a list of your game's current basic system info.

USB Info

This is a list of your game's current USB devices.

Version Info

This is a list of your game's software version.

Back

This will take you back to the **Hardware Tests** menu.



SYSTEM INFO

This is a list of your game's current basic system information, including Hard Drive, CPU and Video Card.

USB INFO

This is a list of your game's current USB devices.

VERSION INFO

This is a list of your machine's software version.

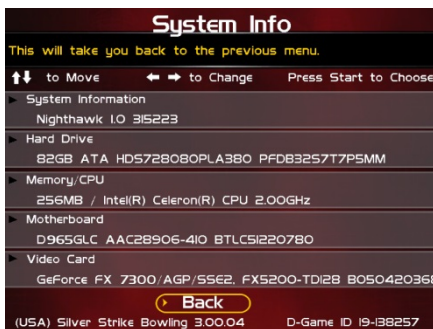

CHECK HARD DRIVE

Check File Data

This test checks the integrity of your hard drive's data.

Select **Begin Test** to initiate the process.

Note: This test can take up to 3 hours to complete.

If this test succeeds you will see the message: **Status: Hard Drive Functioning Properly**. If this test fails, you will see the message: **Hard Drive Error (#)**

Select **Back** to skip the test and return to the **Hardware Tests** menu.

Check File System

This test REBOOTS YOUR GAME and performs a low level systems check of the integrity of your hard drive.

Note: This can take several minutes.

Back

This will take you back to the **Hardware Tests** menu.



CHECK COOLING

This checks that your game is functioning at the proper temperature and all fans are working. The current status is color-coded for easy viewing. If the results are displayed in green, your cabinet is at normal settings.

Note: Cooling information on your system may show up as dashed lines just as shown in the picture. This is because some motherboards do not allow external access to the temperature and fan speeds. This should not be considered a problem.

Back

The Back button takes you back to the **Hardware Tests** menu.



TROUBLESHOOTING SHORTCUTS

This section gathers many of the commonly used tests and menus into one convenient area. Check here first when troubleshooting problems or questions about the integrity of your machine.

The tests that are available in this section are:

- Check Card Reader** – N/A for offline games
- Check Cooling** – See Hardware Tests
- Check Hard Drive** – See Hardware Tests
- Hardware & Software** – See Hardware Tests
- Communications Settings** – N/A for offline games
- Player Control Tests** – See System Tests
- System Tests** – See General Settings

Descriptions of each of these tests can be found elsewhere in the manual

Back

This will take you back to the **Main Menu**.



SILVER STRIKE SETTINGS

Player Cost Schedule

This option allows you to adjust the amount of money it costs a player to play various game types.

Game Audits

This area allows you to view your money audits, game purchase audits, and to reset your audits.

Game Options

This area allows you to adjust options specific to Silver Strike Bowling.

Reset Leaderboards

This will clear all of the game's local leaderboards and high-score screens.

Ticket Dispenser

This area allows you to set and adjust optional ticket dispenser values and settings.

Back

This will take you back to the **Main Menu**.



PLAYER COST SCHEDULE

This screen details the costs of various play selections. The player cost is shown as a total, with the Operator Portion and the ITNet Portion broken out. (ITNet only applies to online games)

Single Play

This option lets you adjust how much it costs a player to play a single 10-frame game of bowling. **The default is set to \$1.00.**

Series Play

This option lets you adjust how much it costs a player to play a 3-game series. **The default is set to \$2.50.**

Spare Challenge

This option lets you adjust the cost of a spare challenge game. **The default is set to \$1.00 per player.**

3-Frame Practice

This option lets you adjust how much it costs a player to play a 3-frame practice game. **The default is set to \$0.50.**

3-Frame Buy In

This option lets you adjust how much it costs a player to buy a second set of 3 frames. **The default is set to \$0.50.**

View Fixed Costs

Not available for offline games.

Player's Card Purchase

Not available for offline games.

Reset Defaults

This resets all values to their default value located on this page.

Back

Select this to return to the **Silver Strike Settings** menu.

Adjustable Costs	Operator Portion	ITNET Portion	Total To Player	Default Value
Single Play	\$ 0.95	\$ 0.05	\$ 1.00	\$ 1.00
Series Play	\$ 2.35	\$ 0.15	\$ 2.50	\$ 2.50
Spare Challenge	\$ 0.95	\$ 0.05	\$ 1.00	\$ 1.00
3 Frame Practice	\$ 0.50	\$ 0.00	\$ 0.50	\$ 0.50
3 Frame Buy In	\$ 0.50	\$ 0.00	\$ 0.50	\$ 0.50
Default	Default	Default	Default	Default

Buttons: View Fixed Costs, Reset Defaults, Back

(USA) Silver Strike Bowling 3.00.04 D-Game ID 19-188257

GAME AUDITS

This section displays various counts and totals for a variety of areas of interest. The following values are based on the last reset, the date of which is shown at the top of the screen.

Coin Slot 1

Coin Slot 2

Bill Acceptor

Lifetime Money In

This field shows how much total money your machine has made. This field is cumulative and is not affected by resetting the audits on this screen.

↑↓ to Move	← → to Change	Press Start to Choose
Audits have never been reset		
Coin Slot 1		\$ 1.00
Coin Slot 2		\$ 0.00
Bill Acceptor		\$ 1.00
Lifetime Money In		\$ 2.00

Buttons: More, Reset Audits, Back

(USA) Silver Strike Bowling 3.05.01 OD-Game ID 14-000575

More

The available audits span a number of different screens. Selecting More brings you to the next page of audit information.



Reset Audits

This will reset the fields on all seven audits screens to zero, and update the date of the last audit reset. The Lifetime Money In field will not be affected by this function.

GAME OPTIONS

Game Options presents a variety of game-specific features that can be turned on or off based on the needs of your location.

Vegas Bowling

This is a selectable game mode that displays cards for every mark earned. Turn this option off in areas where the display of playing cards is not allowed.

Buy Player Cards

Not available for offline games.

Live Contest

Not available for offline games.

Red Pin Mode

With this option on, operators can allow Red Pin strikes. Operators can run Free Automatic Contest and Tournament Software (FACTs) using Red Pins as criteria.

Reset Values

This will reset the fields on all game option menus to their default settings.

More

The available options are displayed on two screens. Selecting More brings you to the next page of game options.

Delay Timeout

This sets the amount of time allowed before any player input is noticed. If the timer runs out before a player moved or the ball is thrown, the ball will be lost. Use this in conjunction with the Ball Timeout setting below to determine when a game is terminated due to timeout.

Ball Timeout

This adjusts the number of balls allowed before ending an unattended game. See Delay Timeout above.

3-Frame Practice

This setting turns the 3-frame game option on or off. The default setting is Off.

Beer Frame Spotlight

This opens the Beer Frame Spotlight menu.

Reset Values

This will reset the fields on all 3 game options menus to their default settings.

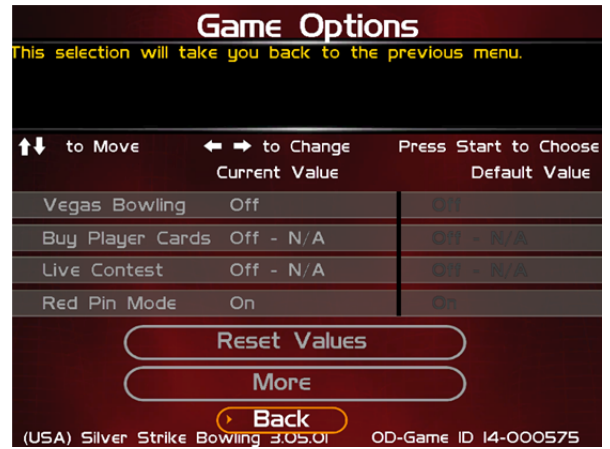

Note: Some states do not allow Live contests. Check your state laws before allowing this option.



BEER FRAME SPOTLIGHT

When the Beer Frame Spotlight mode is turned on, locations can display a promotional message (typically food or drink specials) to patrons. The following options are available for when the message appears: attract mode only, in-game only (during the fifth frame), attract mode and game mode

Use Edit Message to change the message displayed.



RESET LEADERBOARDS

Use this menu to clear the leaderboards or high-score screens. You can reset individual leaderboards or all of them at once.



TICKET DISPENSER

Silver Strike X supports the addition of optional ticket dispenser. Use this menu to set up and test your dispenser, and apply values to the tickets for a variety of award options.

This option will only work if an optional ticket dispenser is installed. Be sure to set the Ticket Dispenser setting to ON from the Dispenser Settings menu.



ITNET SETTINGS

Silver Strike X is an offline product so ITNet Settings are not available.

SILVER STRIKE X TROUBLESHOOTING GUIDE & REFERENCE

APPENDIX A TROUBLESHOOTING GUIDE

Video Problems		
Symptom	Probable Cause	Solution
No picture on the Monitor	I/O Board DIP Switch settings are wrong.	Adjust DIP Switch settings to match the resolution of the monitor you are using. Refer to I/O DIP Switch Settings in Appendix D.
	Incorrect video connection configuration.	Be sure the video connections are correct according to the type of monitor you are using. Refer to the diagrams in Appendix D.
	Monitor does not have a proper A.C. voltage input.	Verify A.C. power to the Nighthawk System box. Verify monitor is working on a known good system.
	Monitor is defective.	Repair or replace.
	Nighthawk System box is defective	Go to Nighthawk System box troubleshooting section.
No picture but game sounds are heard	Incorrect video connection configuration.	Verify video is connected to the system correctly. Refer to the diagrams in Appendix D.
	Since you hear game sounds the system is working.	Review no picture troubleshooting section above.
Scrambled Picture	I/O Board DIP Switch settings are set wrong.	Adjust DIP Switch settings to match the resolution of the monitor you are using. Refer to DIP Switch Settings in Appendix D.
	Incorrect video connection configuration.	Be sure the video connections are correct according to the type of monitor you are using. Refer to the diagrams in Appendix D.
Entire picture is not seen on the screen or it does not fill the entire screen	Misadjusted monitor.	Adjust the monitor width and height. Use video screen adjustment in system tests. Refer to the monitor manual.
Missing or washed out colors	Bad Video connections	Verify continuity from the monitor to the video out on the I/O Board. Red, Green, Blue video signal. <i>Mid. and Low resolution monitors only.</i>
	Contrast and brightness on the monitor needs to be adjusted.	Refer to the monitor manual to make adjustments.
	Defective Monitor.	Verify by connecting a known good monitor to the system.

Sound Problems		
Symptom	Probable Cause	Solution
No audio	Audio Cable between the I/O Board and the Nighthawk system box are not connected.	Verify audio cables are connected. Refer to Appendix D.
	Speakers are not connected properly.	Verify continuity from the I/O Board speaker output pins to the speakers. Refer to Appendix D.
	Volume is set to the lowest level.	Adjust the volume to an audible level.
	Attract mode sounds may be set to all off. You will have sounds when playing the game.	Choose one of the 5 Attract Mode sound options in Sound Adjustments.
	Defective I/O Board.	Verify on a known working system. Replace if necessary.
	Defective Nighthawk system box.	Be certain all other possibilities are explored before replacing the Nighthawk system box.
	DIP switch settings are incorrect for your application	Refer to Monitor Applications at the back of this manual for proper setup.
Distorted or scratchy game audio	Bad speaker.	Replace blown speaker.
	Loose speaker or grill cover is causing vibration.	Verify all components are installed properly and securely.
	Loose/defective audio cables from the Nighthawk system box to the I/O Board.	Check the audio cable connections. Replace cable.
	Defective I/O Board.	Verify on a known working system. Replace if necessary.
	Defective Nighthawk system box.	Be certain all other possibilities are explored before replacing the Nighthawk system box.

Nighthawk System Box Problems		
Symptom	Probable Cause	Solution
No video and no green lights on the I/O Board. Fans are not heard on the Nighthawk System Box.	No AC power to the Nighthawk System Box.	Verify A.C. voltage is connected to the Nighthawk System Box.
	Power switch on the Nighthawk System Box is off.	Flip the Nighthawk System Box power switch to on.
	Main cabinet power switch is off.	Be certain the main cabinet switch is set to on.
	Soft Power Shutdown	Press the Soft Power button with the power turned on. Or, short the top 2 pins of the 6-pin connector on the system box. See Appendix D.
	Defective Nighthawk System Box.	Be certain all other possibilities are explored before replacing the Nighthawk System Box.
No video and no green lights on the I/O Board. Fans are heard on the Nighthawk System Box.	DC power cord not connected from Nighthawk System Box to I/O Board.	Connect the DC power cord from the Nighthawk System Box to the I/O Board.
	Defective I/O Board.	Try it on a known good system. Verify by disconnecting all cables from the I/O Board except the DC power and USB cable to the Nighthawk System Box. No green lights, replace the I/O Board.

Control Problems		
Symptom	Probable Cause	Solution
Button does not work.	Switches Common post is not connected to digital ground.	Verify continuity to digital/power supply ground.
	Signal wire is not connected to the Normally Open post of the switch.	Verify continuity from the I/O Board to the Normally Open post of the switch.
	Switch is defective.	Replace defective switch.
Button always indicates closed in the player control test. Pressing it will show it is not depressed.	Signal wire is connected to the Normally Closed post of the switch.	Connect signal wire to the Normally Open post of the switch.
Button always indicates closed in player control test even with the switch disconnected entirely.	Defective I/O Board.	Test on a known good system. Replace if necessary.
Trackball is not functioning in any direction.	Trackball is not connected to the I/O Board properly.	Verify the trackball is connected to J208 labeled trackball on the I/O Board.
	Defective trackball Interconnect cable.	Verify continuity on the trackball Interconnect cable.
	Trackball is defective.	Replace trackball.
	I/O Board is defective	Replace I/O Board. Try it on a known good system.
Trackball does not work in a certain direction.	Trackball cable is defective.	Verify continuity on the trackball cable. Repair or replace if needed.
	Trackball is defective.	Repair or replace the trackball. Try it on a known working system.
	I/O Board is defective.	Repair or replace the I/O Board. Try it on a known working system.
Trackball works intermittently.	Inside of the trackball is dirty.	Clean the inside of the trackball.
	Rollers are worn.	Replace the rollers and bearings.
	Trackball is over-tightened.	Do not over-tighten the trackball. Tighten just enough to flatten the lock washers.

HDTV Video Problems		
Symptom	Probable Cause	Solution
There is no picture during boot up.	Incorrect video cable configuration.	Be sure you are using the proper cable connections. Refer to the HDTV connections configurations.
	Connected to the wrong output on the system box	Refer to the HDTV connections configurations.
	Connected to the wrong input on the HDTV	HDTVs usually have more than 1 input for a certain input type. Examples are Component 1 & 2; HDMI 1 & 2.
	Incorrect input selected on the HDTV	Be sure the correct input is selected from the HDTV input menu. Example: If using HDMI 1 that input must be selected from the HDTV video input menu.
	DIP switch setting SW 201 on the I/O Board set incorrectly.	Sw201 on the I/O Board must be configured to match the method of video you are using.

Symptom	Probable Cause	Solution
No picture after boot up	Normal black screen is displayed for a period of time just before 3D graphics are displayed.	This is normal operation. Be sure to wait at least two minutes after LOADING GAME is displayed to see if video appears.
	Your VGA cable is connected to the second monitor output.	Connect the VGA connector to the main output port.
Distorted or fuzzy picture	Improper cable connection	Be sure the video cables are securely connected at the computer video card and at the HDTV. This is especially critical if using a component video cable.
Picture is too big for the screen or does not fill the entire screen.	Incorrect DIP switch configuration.	Be sure Sw201 is configured to match the desired video.
	Increase or decrease screen size in games adjustments.	Location is in General Settings> System Tests>Video Tests>Screen Size Adjust

HDTV Audio Problems

No Audio	RCA audio cable is not connected to the system box or HDTV	Connect the RCA audio cable to the system box and then to the proper input on the HDTV.
	RCA audio cable is connected to the wrong audio input of the HDTV	You must connect the audio cable to the matching video input selected. For example: If you are using Component 1 the audio must go to Component 1.
	HDTV audio is muted	Turn the mute off in the HDTV menu.
	Volume is turned down on the monitor or game sounds are set too low.	Adjust the volume on the game to 75% and then adjust the game volume to your desired level.
Low volume	Volume is turned down on the monitor or game sounds are set too low.	Adjust the volume on the game to 75% and then adjust the game volume to your desired level.
Scratchy or distorted audio	Poor cable connection RCA cable	Be sure the RCA audio cable is securely and entirely connected the mating connectors.
No audio	DIP switch settings are incorrect for your application	Refer to Monitor Applications at the back of this manual for proper setup.

Flash Code Messages		
Flash Code (I/O Diode D102)	Code Description	Solution
Flash Code 2	Possible I/O Board failure	First Check Connections. Turn off game, wait 10 seconds, turn game on. If Problem persists call IT tech support.
Flash Code 3	Info: Last reboot due to Watchdog time out.	Turn off game, wait 10 seconds, turn game on. If Problem persists call IT tech support.
Flash Code 4	Error When updating CID to latest Version	Typically CID failure. Turn off game, wait 10 seconds, turn game on. If Problem persists call IT tech support.
Flash Code 5	Updated USB CID was detected. This is not an error but a notification.	Turn off game, wait 10 seconds, turn game on. If Problem persists call IT tech support.
Flash Code 6	Disconnected Cabinet ID Device (CID) was detected.	Check USB connection. Turn off game, wait 10 seconds, turn game on. If Problem persists call IT tech support.
Flash Code 7	CID Malfunction. Typically CID is defective.	Turn off game, wait 10 seconds, turn game on. If Problem persists call IT tech support.
Flash Code 10	Error When updating USB I/O Board to latest version. Typically an I/O Board failure	Turn off game, wait 10 seconds, turn game on. If Problem persists call IT tech support.
Flash Code 11	Updated USB I/O Board to latest version. This is not an error but a notification.	Turn off game, wait 10 seconds, turn game on. If Problem persists call IT tech support.
Flash Code 12	A disconnected I/O Board was detected.	Turn off game, Check USB and power connections, turn game on. If Problem persists call IT tech support.
Flash Code 13	I/O Board malfunction. Typically I/O Board has failed.	Turn off game, wait 10 seconds, turn game on. If Problem persists call IT tech support.
Flash Code 14	Game is incompatible with USB I/O Board.	This usually means the wrong type of I/O Board. It does not match the system box software. Try turning off game, wait 10 seconds, turn game on. If problem persists call IT tech support.

Miscellaneous Problems		
Symptom	Probable Cause	Solution
Unable to exit Operator Menus.	DIPswitch SW202 position 4 is in the on position.	Set position 4 of SW202 to off. Press start to exit.
	Test switch wired from the I/O Board is closed.	Verify satellite test switch is not closed.
No fluorescent light	No 120 volts A.C. power going to the light fixture.	Verify A.C. voltage to the light fixture.
	Defective fluorescent light.	Replace fluorescent light.
	Defective starter	Replace the starter.
	Defective ballast.	Replace the ballast.
Coin Meter is not working	Defective Coin Meter	Replace with a known good one.
	Not wired properly	Connect one lead to +5 or +12 volts depending on device. The other lead to coin meter on Service Panel Pin 2.
	Defective I/O Board	Replace with a known good board.

APPENDIX B

INPUT/OUTPUT CONNECTIONS (I/O POWER, TRACKBALL, ETC.)

For Standard Online Kit and Deluxe Retrofit Kit

Trackball Harness Connector Pin Outs

I/O Board Connector	Trackball Connector
PIN WIRE #6 – Black	PIN WIRE #1 – Black
PIN WIRE #1 – Red	PIN WIRE #2 – Red
PIN WIRE #2 – Yellow	PIN WIRE #3 – Yellow
PIN WIRE #3 – Green	PIN WIRE #4 – Green
PIN WIRE #5 – Blue	PIN WIRE #5 – Blue
PIN WIRE #4 – Purple	PIN WIRE #6 – Purple

I/O Power Cable Pin Outs

Pin Number	Wire Color	Function
1	Yellow	+ 12 Volts DC
2	Black	Ground
3	Red	+ 5 Volts DC
4	Black	Ground

Control Panel J203 Connector Pin Outs

Pin	Color	Function
1	Green-White	Options
2	Brown-White	Left
3		No Connection
4	Yellow-White	Right
5	Violet-White	Flyby
6	Black	Volume GND
7	Black-White	Spin
8	Blue-White	Help
9	Red-White	Start
10	Black	Ground

Lamps J202 Connector Pin Outs

Pin	Color	Function
1	Red-Black	Lamp Power – Buttons
5	Red-Yellow	Help Lamp
6	Red-Green	Options Lamp

Speakers J301

Pin	Color	Function
1	Yellow-Red	Left Speaker +
2	Yellow-Green	Left Speaker -
3	White-Red	Right Speaker +
4	White-Green	Right Speaker -

Service Panel J206

Pin	Color	Function
1	Red-Black	Meter Power
2	Red-Green	Coin Meter
3	Orange-White	Volume Up
4	Orange-Yellow	Volume Down
5		No Connection
6	Blue	Test
7	Black	Test Ground

Coin Door J205

Pin	Color	Function
1	Red-Black	Lamp Power
2	Black	Lamp Ground
3		No Connection
4	Black	Bill Ground
5	Grey-White	Bill
6		No Connection
7		No Connection
8	Green-Blue	Coin 2
9	Red-Blue	Coin 1
10		No Connection
11	Black	Coin Ground

APPENDIX C REPLACEMENT PART NUMBERS

Please refer to these IT part numbers when placing orders.

Part Number	Description
925000339P	SHOWPIECE SSX
900196007R	CABINET IDENTIFICATION DEVICE, SSX
915250304R	CABLE ASSY, I/O POWER FOR KITS
915000745	CABLE ASSY, POWER CORD. A.C.
915000173R	CABLE ASSY, TRACKBALL/GUN INTERFACE
938291715	CASH VAULT, COMPLETE ASSY DBA
999000715	CASH VAULT, HOUSING ONLY (NO CARD READER OR DBA)
825100265R	CONTROL PANEL OVERLAY, DIECUT WITH CONTROL LABELS/TB HOLE
999000288	DBA, MARS \$1/5 BILL ACCEPTOR MODEL AE2481D5E (FOR IT CASH VAULT ONLY)
840500288R	SILVERSTRIKE.COM CARD
900339000R	I/O BOARD FOR US SSX W/ MODEM
925000339	KIT - US SSX
820000339R	MARQUEE, SSX
850000001R	PUSHBUTTON ASSY, RED WITH VERTICAL MOUNTED SWITCH
850000003R	PUSHBUTTON ASSY, WHITE WITH VERTICAL MOUNTED SWITCH
840675640	QUICK INSTALL GUIDE SSX
900675312R	SYSTEM BOX, SSX
880000030R	TRACKBALL ASSY, 3" WHITE
885000030R	TRACKBALL PLATE FOR 3" TRACKBL WITH STANDOFFS
915250308R	CABLE ASSY, INPUT/OUTPUT FOR KITS W/6005 I/O BOARD

APPENDIX D SYSTEM DIAGRAMS

Detailed Cable Connection Diagram

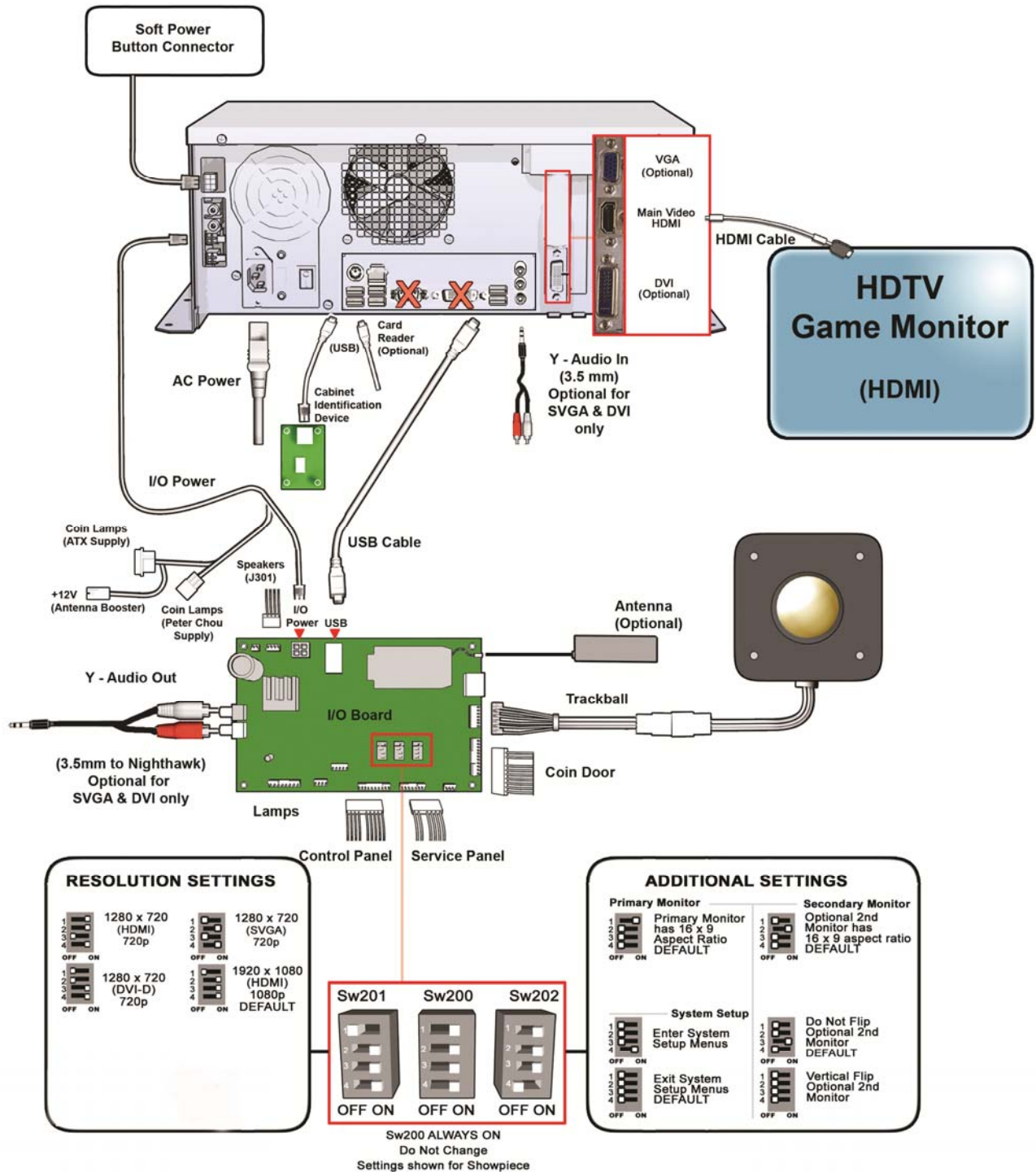

Nighthawk System Box Diagram

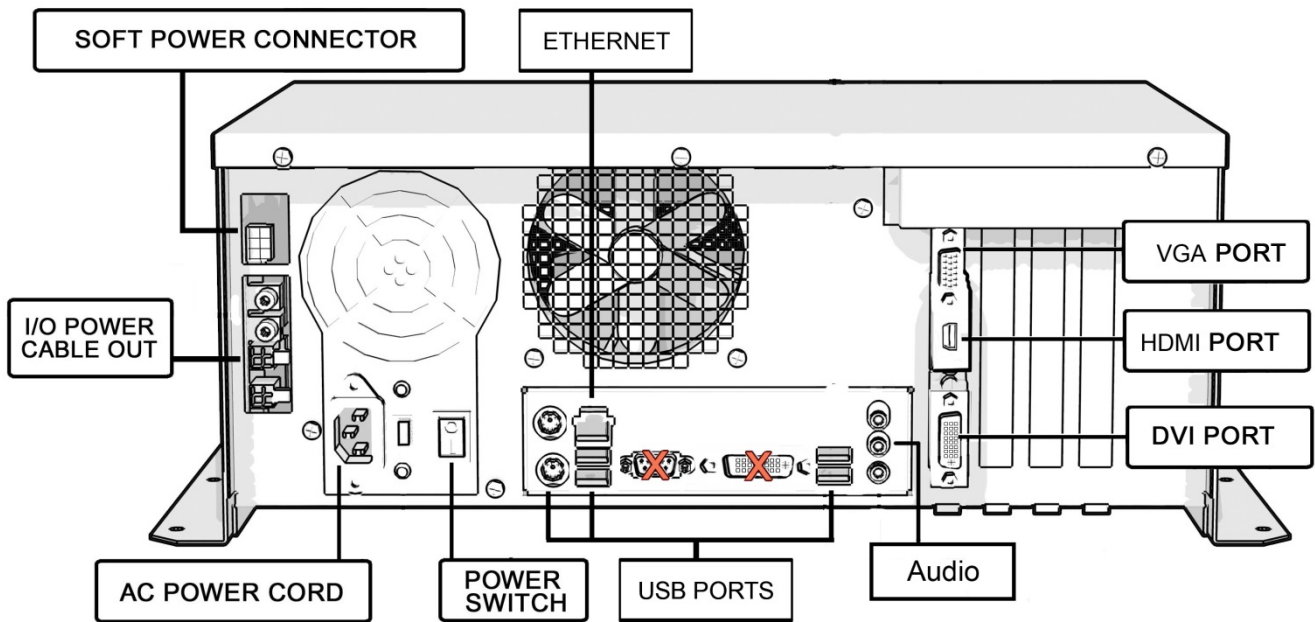

I/O Card Diagram

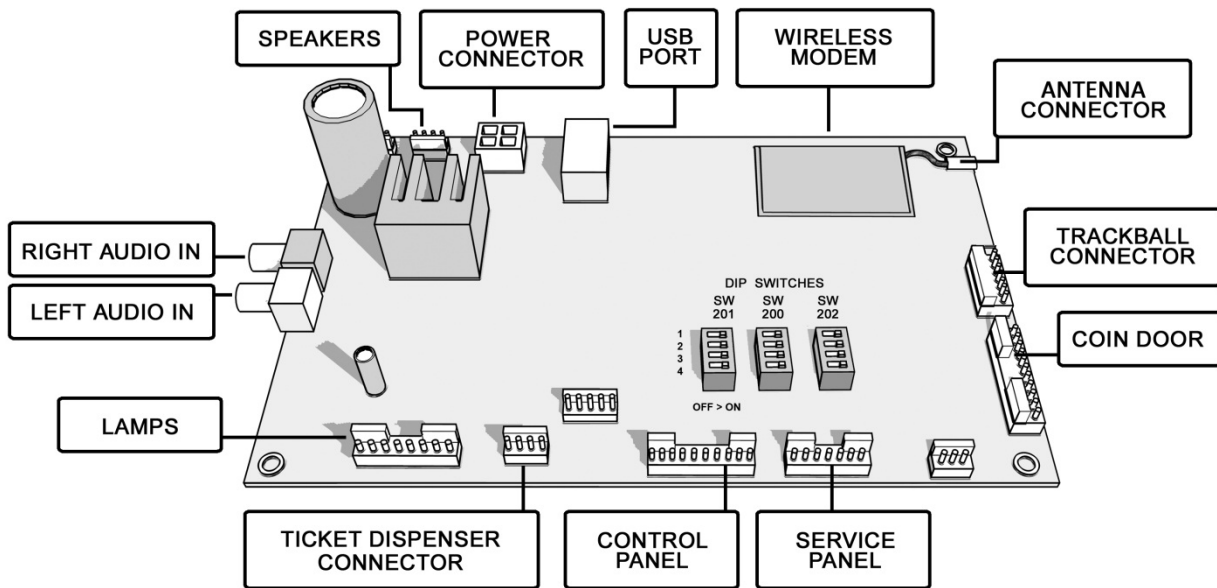

HDTV MONITOR APPLICATION

IMPORTANT NOTE

I/O CARD DIAGRAM FOR ORIENTATION

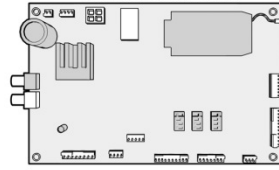

Sw201 Sw200 Sw202

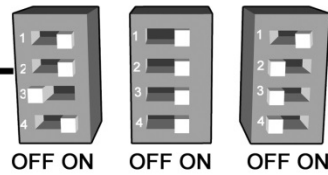

Sw200 ALWAYS ON
Do Not Change
Settings shown for Showpiece

RESOLUTION SETTINGS

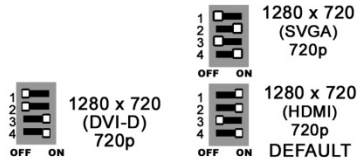

ADDITIONAL SETTINGS

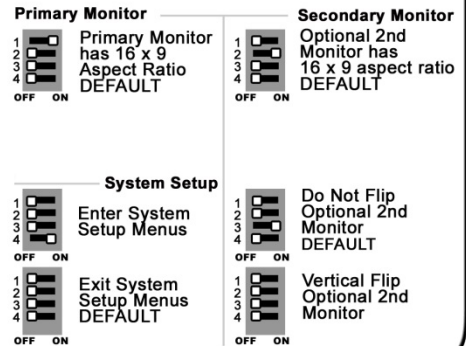

Note: In the Additional Settings above, ONLY the ON switch matters for correct setup and operation.

APPENDIX E

GNU General Public License

TERMS AND CONDITIONS FOR COPYING, DISTRIBUTION AND MODIFICATION

0. This License applies to any program or other work which contains a notice placed by the copyright holder saying it may be distributed under the terms of this General Public License. The "Program", below, refers to any such program or work, and a "work based on the Program" means either the Program or any derivative work under copyright law: that is to say, a work containing the Program or a portion of it, either verbatim or with modifications and/or translated into another language. (Hereinafter, translation is included without limitation in the term "modification".) Each licensee is addressed as "you".

Activities other than copying, distribution and modification are not covered by this License; they are outside its scope. The act of running the Program is not restricted, and the output from the Program is covered only if its contents constitute a work based on the Program (independent of having been made by running the Program). Whether that is true depends on what the Program does.

1. You may copy and distribute verbatim copies of the Program's source code as you receive it, in any medium, provided that you conspicuously and appropriately publish on each copy an appropriate copyright notice and disclaimer of warranty; keep intact all the notices that refer to this License and to the absence of any warranty; and give any other recipients of the Program a copy of this License along with the Program.

You may charge a fee for the physical act of transferring a copy, and you may at your option offer warranty protection in exchange for a fee.

2. You may modify your copy or copies of the Program or any portion of it, thus forming a work based on the Program, and copy and distribute such modifications or work under the terms of Section 1 above, provided that you also meet all of these conditions:

a) You must cause the modified files to carry prominent notices stating that you changed the files and the date of any change.

b) You must cause any work that you distribute or publish, that in whole or in part contains or is derived from the Program or any part thereof, to be licensed as a whole at no charge to all third parties under the terms of this License.

c) If the modified program normally reads commands interactively when run, you must cause it, when started running for such interactive use in the most ordinary way, to print or display an announcement including an appropriate copyright notice and a notice that there is no warranty (or else, saying that you provide a warranty) and that users may redistribute the program under these conditions, and telling the user how to view a copy of this License. (Exception: if the Program itself is interactive but does not normally print such an announcement, your work based on the Program is not required to print an announcement.) These requirements apply to the modified work as a whole. If identifiable sections of that work are not derived from the Program, and can be reasonably considered independent and separate works in themselves, then this License, and its terms, do not apply to those sections when you distribute them as separate works. But when you distribute the same sections as part of a whole which is a work based on the Program, the distribution of the whole must be on the terms of this License, whose permissions for other licensees extend to the entire whole, and thus to each and every part regardless of who wrote it.

Thus, it is not the intent of this section to claim rights or contest your rights to work written entirely by you; rather, the intent is to exercise the right to control the distribution of derivative or collective works based on the Program.

In addition, mere aggregation of another work not based on the Program with the Program (or with a work based on the Program) on a volume of a storage or distribution medium does not bring the other work under the scope of this License.

3. You may copy and distribute the Program (or a work based on it, under Section 2) in object code or executable form under the terms of Sections 1 and 2 above provided that you also do one of the following:

a) Accompany it with the complete corresponding machine-readable source code, which must be distributed under the terms of Sections 1 and 2 above on a medium customarily used for software interchange; or,

b) Accompany it with a written offer, valid for at least three years, to give any third party, for a charge no more than your cost of physically performing source distribution, a complete machine-readable copy of the corresponding source code, to be distributed under the terms of Sections 1 and 2 above on a medium customarily used for software interchange; or,

c) Accompany it with the information you received as to the offer to distribute corresponding source code. (This alternative is allowed only for noncommercial distribution and only if you received the program in object code or executable form with such an offer, in accord with Subsection b above.)

The source code for a work means the preferred form of the work for making modifications to it. For an executable work, complete source code means all the source code for all modules it contains, plus any associated interface definition files, plus the scripts used to control compilation and installation of the executable. However, as a special exception, the source code distributed need not include anything that is normally distributed (in either source or binary form) with the major components (compiler, kernel, and so on) of the operating system on which the executable runs, unless that component itself accompanies the executable.

If distribution of executable or object code is made by offering access to copy from a designated place, then offering equivalent access to copy the source code from the same place counts as distribution of the source code, even though third parties are not compelled to copy the source along with the object code.

4. You may not copy, modify, sublicense, or distribute the Program except as expressly provided under this License. Any attempt otherwise to copy, modify, sublicense or distribute the Program is void, and will automatically terminate your rights under this License. However, parties who have received copies, or rights, from you under this License will not have their licenses terminated so long as such parties remain in full compliance.

5. You are not required to accept this License, since you have not signed it. However, nothing else grants you permission to modify or distribute the Program or its derivative works. These actions are prohibited by law if you do not accept this License. Therefore, by modifying or distributing the Program (or any work based on the Program), you indicate your acceptance of this License to do so, and all its terms and conditions for copying, distributing or modifying the Program or works based on it.

6. Each time you redistribute the Program (or any work based on the Program), the recipient automatically receives a license from the original licensor to copy, distribute or modify the Program subject to these terms and conditions. You may not impose any further restrictions on the recipients' exercise of the rights granted herein. You are not responsible for enforcing compliance by third parties to this License.

7. If, as a consequence of a court judgment or allegation of patent infringement or for any other reason (not limited to patent issues), conditions are imposed on you (whether by court order, agreement or otherwise) that contradict the conditions of this License, they do not excuse you from the conditions of this License. If you cannot distribute so as to satisfy simultaneously your obligations under this License and any other pertinent obligations, then as a consequence you may not distribute the Program at all. For example, if a patent license would not

permit royalty-free redistribution of the Program by all those who receive copies directly or indirectly through you, then the only way you could satisfy both it and this License would be to refrain entirely from distribution of the Program.

If any portion of this section is held invalid or unenforceable under any particular circumstance, the balance of the section is intended to apply and the section as a whole is intended to apply in other circumstances.

It is not the purpose of this section to induce you to infringe any patents or other property right claims or to contest validity of any such claims; this section has the sole purpose of protecting the integrity of the free software distribution system, which is implemented by public license practices. Many people have made generous contributions to the wide range of software distributed through that system in reliance on consistent application of that system; it is up to the author/donor to decide if he or she is willing to distribute software through any other system and a licensee cannot impose that choice.

This section is intended to make thoroughly clear what is believed to be a consequence of the rest of this License.

8. If the distribution and/or use of the Program is restricted in certain countries either by patents or by copyrighted interfaces, the original copyright holder who places the Program under this License may add an explicit geographical distribution limitation excluding those countries, so that distribution is permitted only in or among countries not thus excluded.

In such case, this License incorporates the limitation as if written in the body of this License.

9. The Free Software Foundation may publish revised and/or new versions of the General Public License from time to time. Such new versions will be similar in spirit to the present version, but may differ in detail to address new problems or concerns.

Each version is given a distinguishing version number. If the Program specifies a version number of this License which applies to it and "any later version", you have the option of following the terms and conditions either of that version or of any later version published by the Free Software Foundation. If the Program does not specify a version number of this License, you may choose any version ever published by the Free Software Foundation.

10. If you wish to incorporate parts of the Program into other free programs whose distribution conditions are different, write to the author to ask for permission. For software which is copyrighted by the Free Software Foundation, write to the Free Software Foundation; we sometimes make exceptions for this. Our decision will be guided by the two goals of preserving the free status of all derivatives of our free software and of promoting the sharing and reuse of software generally.

NO WARRANTY

11. BECAUSE THE PROGRAM IS LICENSED FREE OF CHARGE; THERE IS NO WARRANTY FOR THE PROGRAM, TO THE EXTENT PERMITTED BY APPLICABLE LAW. EXCEPT WHEN OTHERWISE STATED IN WRITING THE COPYRIGHT HOLDERS AND/OR OTHER PARTIES PROVIDE THE PROGRAM "AS IS" WITHOUT WARRANTY OF ANY KIND, EITHER EXPRESSED OR IMPLIED, INCLUDING, BUT NOT LIMITED TO, THE IMPLIED WARRANTIES OF MERCHANTABILITY AND FITNESS FOR A PARTICULAR PURPOSE. THE ENTIRE RISK AS TO THE QUALITY AND PERFORMANCE OF THE PROGRAM IS WITH YOU. SHOULD THE PROGRAM PROVE DEFECTIVE, YOU ASSUME THE COST OF ALL NECESSARY SERVICING, REPAIR OR CORRECTION.

12. IN NO EVENT UNLESS REQUIRED BY APPLICABLE LAW OR AGREED TO IN WRITING WILL ANY COPYRIGHT HOLDER, OR ANY OTHER PARTY WHO MAY MODIFY AND/OR REDISTRIBUTE THE PROGRAM AS PERMITTED ABOVE, BE LIABLE TO YOU FOR DAMAGES, INCLUDING ANY GENERAL, SPECIAL, INCIDENTAL OR CONSEQUENTIAL DAMAGES ARISING OUT OF THE USE OR INABILITY TO USE THE PROGRAM (INCLUDING BUT NOT LIMITED TO LOSS OF DATA OR DATA BEING RENDERED INACCURATE OR LOSSES SUSTAINED BY YOU OR THIRD PARTIES OR A FAILURE OF THE PROGRAM TO OPERATE WITH ANY OTHER PROGRAMS), EVEN IF SUCH HOLDER OR OTHER PARTY HAS BEEN ADVISED OF THE POSSIBILITY OF SUCH DAMAGES.

How to Apply These Terms to Your New Programs If you develop a new program, and you want it to be of the greatest possible use to the public, the best way to achieve this is to make it free software which everyone can redistribute and change under these terms.

To do so, attach the following notices to the program. It is safest to attach them to the start of each source file to most effectively convey the exclusion of warranty; and each file should have at least the "copyright"

line and a pointer to where the full notice is found.

One line to give the program's name and an idea of what it does.

Copyright (C) yyyy name of author

This program is free software; you can redistribute it and/or modify it under the terms of the GNU General Public License as published by the Free Software Foundation; either version 2 of the License, or (at your option) any later version.

This program is distributed in the hope that it will be useful, but WITHOUT ANY WARRANTY; without even the implied warranty of MERCHANTABILITY or FITNESS FOR A PARTICULAR PURPOSE. See the GNU General Public License for more details.

You should have received a copy of the GNU General Public License along with this program; if not, write to the Free Software Foundation, Inc., 59 Temple Place - Suite 330, Boston, MA 02111-1307, USA.

Copyright 2004 Incredible Technologies, Inc. (IT). Certain programs, identified at IT's Website are free software subject to an associated license.

1. Because certain programs are licensed free of charge, see IT's website, there is no warranty for such programs to the extent permitted by applicable law. Except when otherwise stated in writing the copyright holders and/or other parties provide those programs "as is" without warranty of any kind, either expressed or implied, including, but not limited to, the implied warranties of merchantability and fitness for a particular purpose. The entire risk as to the quality and performance of those programs is with you. Should the programs prove defective, you assume the cost of all necessary servicing, repair or correction.

2. In no event unless required by applicable law or agreed to in writing will any copyright holder, or any other party who may modify and/or redistribute those programs be liable to you for damages including any general, special, incidental or consequential damages arising out of the use or inability to use those programs (including but not limited to loss of data or data being rendered inaccurate or losses sustained by you or third parties or a failure of those programs to operate with any other programs), even if such holder or other party has been advised of the possibility of such damages.

A complete machine-readable copy of the source code of those programs and associated license is available to any third party, at the IT website.

APPENDIX F MENU NAVIGATION SHORTCUTS

Change Collection Settings

- Push the red System Setup button inside the coin door
- Select **General Settings** menu
- Select **Operator Adjustables** menu
- Select **Collection Settings** menu
- Select the menu that you want changed

Add Operator Free Cash

- Push the red System Setup button inside the coin door
- Select **Collection and Earnings**
- Select **Add Free Cash**
- Move the trackball left/right to select the desired dollar amount

GAME ICON DESCRIPTIONS

Cooling Icon

The cooling icon (pictured right) will appear in the game's attract mode to warn you that a fan is not operating at minimum recommended standards. If the fans do not operate at suggested levels it may cause your game to overheat and fail.

Call Incredible Technologies Technical Support at 847-870-7027 x121 for assistance.



**APPENDIX G
MOUNTING TEMPLATES**



MONITOR
DIRECTION

TRACKBALL ORIENTATION DIAGRAM

(VIEWED FROM UNDERSIDE OF CONTROL PANEL)

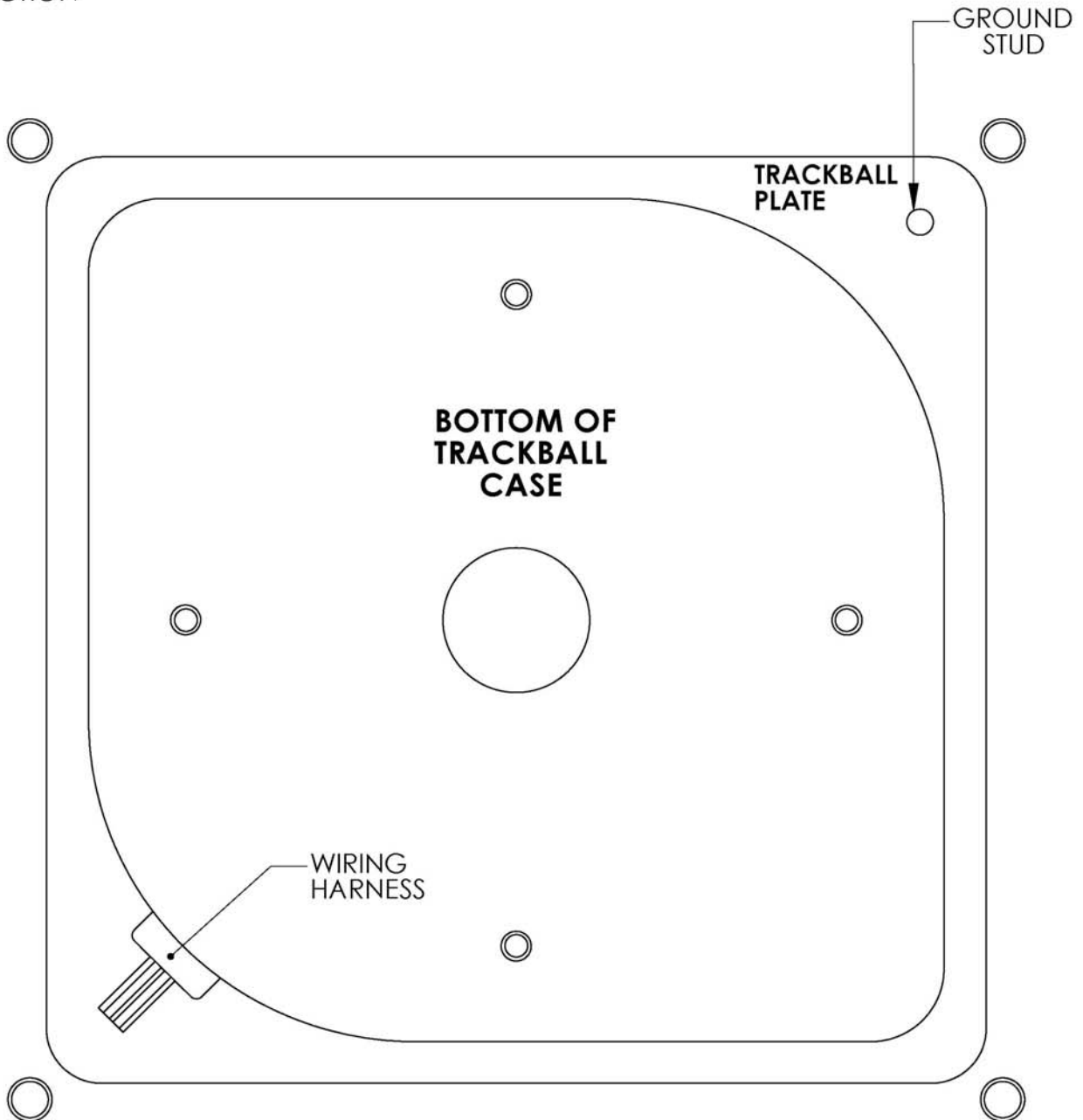

INSTALLATION NOTES:

- 1) THE WIRING HARNESS SHOULD POINT AWAY FROM THE MONITOR AND TO THE LEFT.
- 2) GROUND PIN SHOULD BE TOWARD THE MONITOR AND ON THE RIGHT SIDE.

TOOLS REQUIRED:
DRILL, 9/32" OR 5/16" & 3/4" DRILL BITS, SABRE SAW, SCISSORS, & ROUTER

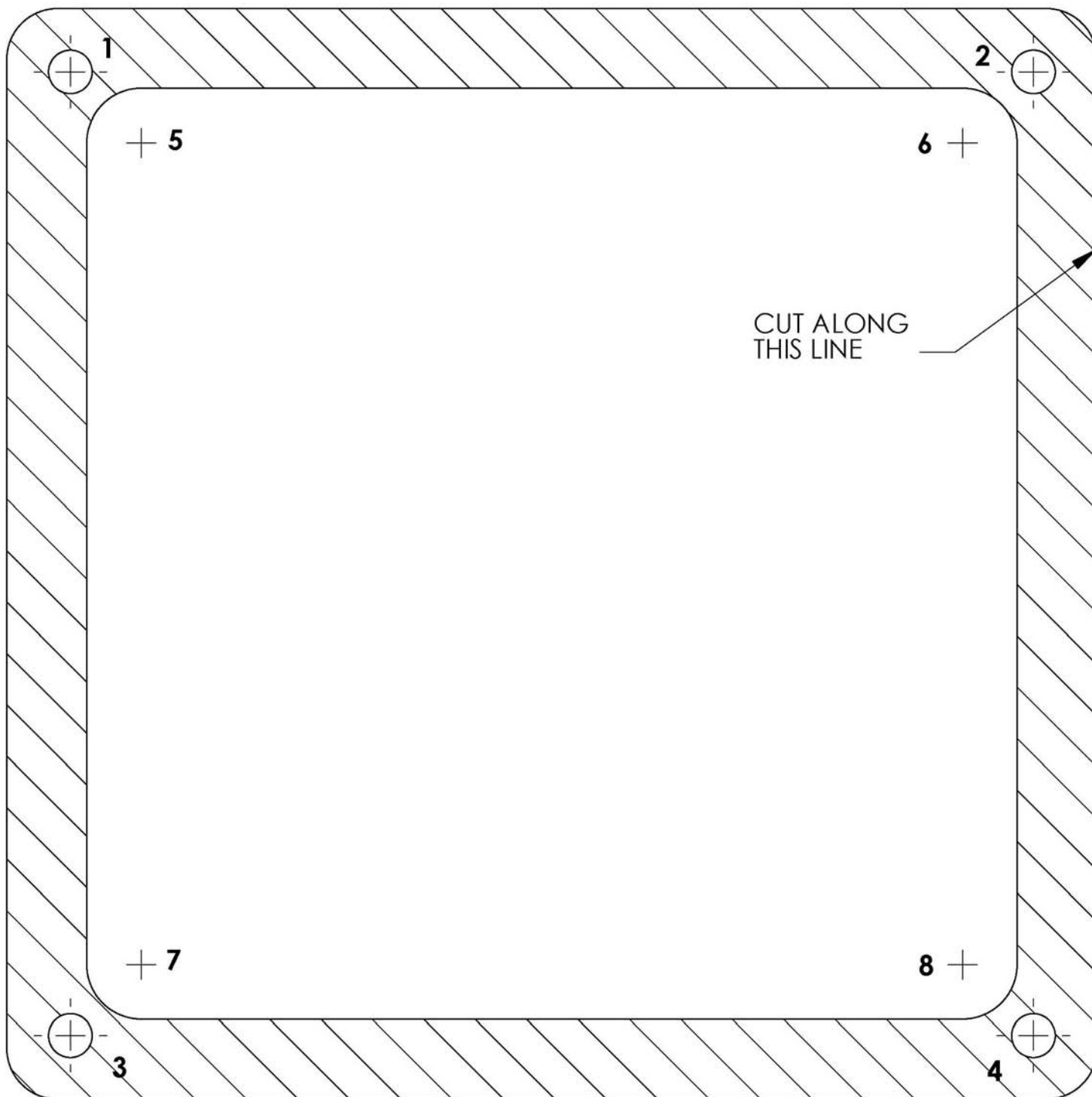

INSTRUCTIONS:

- 1) CUT THE TEMPLATE OUT WITH A PAIR OF SCISSORS ALONG THE NOTED LINE. TAPE THIS TEMPLATE TO THE TOP OF THE CONTROL PANEL AS FAR AWAY FROM THE MONITOR AS POSSIBLE, MAKING SURE THAT THE TRACKBALL WILL CLEAR THE CABINET BENEATH IT.
- 2) USING A SHARP OBJECT, MARK THE (8) POINTS SHOWN HERE ON THE CONTROL PANEL. USING A PENCIL, TRACE THE OUTSIDE OF THE TEMPLATE. REMOVE THE TEMPLATE.
- 3) DRILL HOLES 1-4 WITH THE 9/32" OR 5/16" DRILL BIT.
- 4) DRILL HOLES 5-8 WITH THE 3/4" DRILL BIT.
- 5) ROUTE THE CROSSHATCHED REGION TO A DEPTH OF ABOUT .075" (ABOUT THE THICKNESS OF A NICKEL).
- 6) USING THE SABRE SAW CUT OUT THE CENTER PORTION BY CUTTING BETWEEN HOLES 5-8.

LEFT BUTTON DRILL TEMPLATE

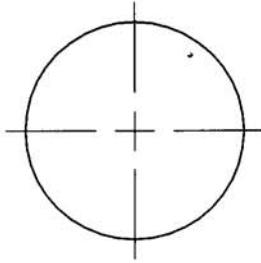
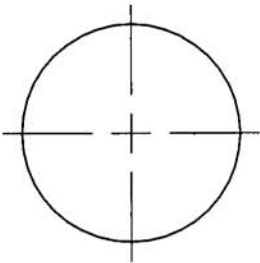

2

THE CENTER OF
BUTTON #2 SHOULD
BE LOCATED 2.75"
ABOVE, AND 9" TO
THE LEFT OF THE
CENTER OF THE
TRACKBALL.

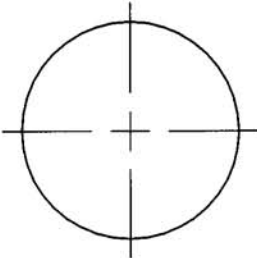

RIGHT BUTTON DRILL TEMPLATE

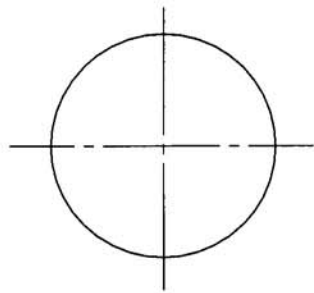

1

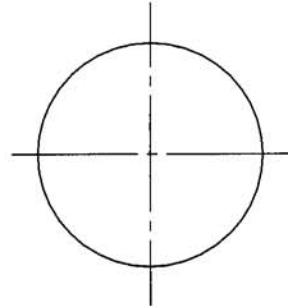
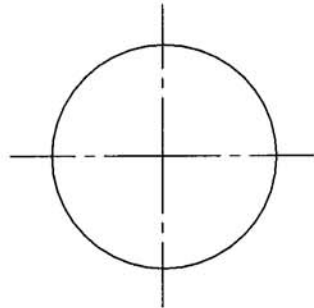
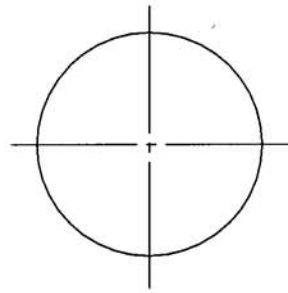

- 1) THE CENTER OF BUTTON #1 SHOULD BE LOCATED APPROX. 8" TO THE RIGHT OF THE CENTER OF THE TRACKBALL WITH THE BUTTONS CENTERED ABOUT THE TRACKBALL VERTICALLY.
- 2) FOR GOLDEN TEE FORE CABINETS THE #1 BUTTON HOLE SHOULD BE ALIGNED WITH THE EXISTING BACKSPIN BUTTON HOLE.

Contact Information

IT Sales and Service

To purchase additional Golden Tee machines or any of IT's other fine products, please visit IT's website at www.itsgames.com and click on PRODUCTS!

For the phone numbers below, when prompted "if you know your party's extension you may enter it at any time", enter the three-digit number following the "x".

General Numbers

IT Sales Hotline:

800-262-0323 x383

847-870-7027 x383

Technical Support, Warranty & Repair:

Incredible Technologies, Inc.

800-262-0323 x380 or x381

847-870-7027 x380 or x381

847-454-9008 Fax

Parts and Customer Service:

Incredible Technologies, Inc.

800-262-0323 x386

847-870-7027 x 386

847-454-9156 Fax

Operator Services:

Incredible Technologies, Inc.

800-262-0323 x382

847-870-7027 x382

847-454-9155 Fax

Accounting

Incredible Technologies, Inc.

800-262-0323 x382

847-870-7027 x382

847-454-9007 Fax

IT Mailing Address:

Incredible Technologies, Inc.
200 Corporate Woods Parkway
Vernon Hills, IL 60061

ITNet Registration Fax Number

847-454-9155

Sales Fax Number

847-454-9156

General Fax Number: 847-870-0120
Tech Services Fax Number: 847-454-9008

IT Vendor Information

Mars Technical Service:

Phone: 800-345-8172

Happ Controls:

Phone: 888-289-4277



Incredible Technologies, Inc.
200 Corporate Woods Parkway
Vernon Hills, IL 60061

Phone (847) 870-7027 (800) 262-0323
www.itsgames.com