

# Showpiece Cabinet Integrated Stand For 32" - 52" LCD HDTV



## Installation and Assembly Instructions

© 2017 Incredible Technologies Inc.

Version 0417

## Important Safety Instructions

- Read these instructions
- Keep these instructions
- Heed all warnings
- Follow all instructions



- Be sure top of cabinet has at least 24" or 61cm of clearance in all directions.
- Do not attempt to move the cabinet with stand or HDTV attached.
- Insufficient clearance or movement while attached may result in damage to monitor or player injury.
- Read the entire manual before starting installation and assembly. If you have any questions please call IT Tech Support at 847-870-7027 x380.
- Installation should only be attempted by someone with good mechanical aptitude and understands these instructions completely.
- A qualified assistant is recommended to safely lift and position equipment.
- Use appropriate safety gear and tools to avoid injury to your equipment, yourself or others.
- Never exceed the 100 lb (45 kg) Maximum Load Capacity.
- Make sure all screws are tightened firmly, but do not overtighten screws. Overtightening screws can cause damage and reduce their lifespan and holding power.
- Take care in your placement of the cabinet and stand, and avoid heavy traffic areas, vibration and chance of impact. Damage to equipment and customers can occur from a falling screen or tipped cabinet.
- Do not install near sources of heat, such as heating or air conditioning vents, fireplaces, or direct sunlight.





## Table of Contents

Parts Lists	4
Required Tools	5
Step 1: Attach Base Beams to Showpiece Cabinet	6
Step 2: Attach the Monitor Plate to Mounting Poles	7
Step 3: Attach Pole Assembly to Base Beams	7
Step 4: Attach Vertical & Marquee Brackets to HDTV	8
Step 5: Mount HDTV to Monitor Plate	9
Step 6: Attach Marquee Assembly	9



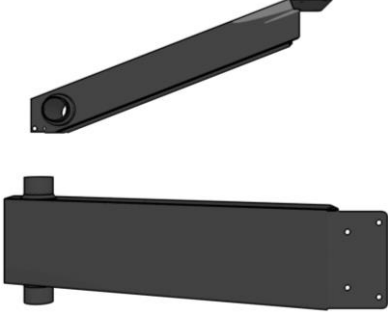

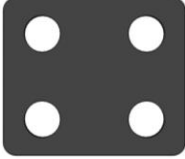
## Parts Lists

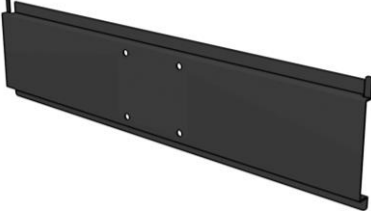
Before assembly is started, check the contents of your Stand kit to the list of components identified in this section.



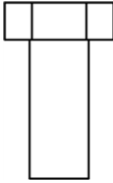
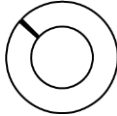

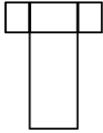

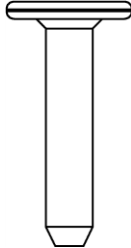
### Stand Components

 <p>2 Base Beams SM 304-400</p>	 <p>2 Vertical Poles SM304-403</p>	 <p>2 Base Connector Plate SM304-407</p>
 <p>2 Vertical Brackets SM 304-406</p>	 <p>Horizontal Monitor Plate SM331-378</p>	

### Stand Hardware

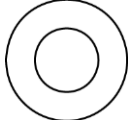
 <p>12 - 5/16"-18 x 3/4 hex head screws 92865A578</p>	 <p>12 - 5/16 split lock washers 90126A030</p>	 <p>8 - 5/16-18 nuts 95462A030</p>
 <p>4 - 1/4-28 x 1/2 hex head screws 92865A002</p>	 <p>2 - 8-32 x 1 1/4" hex head screws 90272A201</p>	 <p>2 - Stafast mounting bolts BB142030UHD</p>

## Screen Mounting Hardware (M4 TV Hardware, M6 TV Hardware)

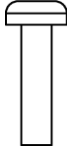
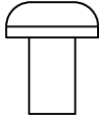
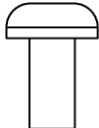
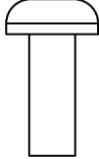
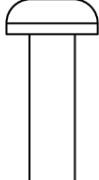
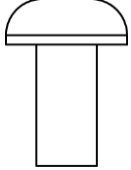
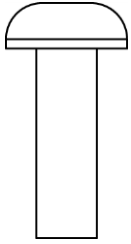
 <p>8 M4 fender flat washers 91100A130</p>	 <p>8 M6 flat washers 91455A120</p>	 <p>8 M8 flat washers 91455A130</p>
 <p>4 M4 split lock washers 91202A226</p>	 <p>4 M6 split lock washers 91202A234</p>	 <p>4 M8 split lock washers 91202A238</p>
 <p>4 M4 x 16 Phillips Screws 92005A226</p>	 <p>4 M6 x 10 Phillips Screws 92005A420</p>	 <p>4 M6 x 12 Phillips Screws 92005A422</p>
 <p>4 M6 x 16 Phillips Screws 92005A426</p>	 <p>4 M6 x 20 Phillips Screws 92005A428</p>	 <p>4 M8 x 16 Phillips Screws 92005A526</p>
 <p>4 M8 x 25 Phillips Screws 92005A530</p>		

## Required Tools

- Phillips and Flat Screwdrivers
- 7/16" and 1/2" Socket, Nut Driver, and/or Open-end Wrenches
- 4mm Hex Key

## Step 1: Attach Base Beams to Showpiece Cabinet

The Stand is affixed to the lower back section of the Showpiece Cabinet. Install one Base Beam on one side first, and then move to the other side. The two Base Beam components are identical and interchangeable.

**NOTE:** You may need to prop up the opposite end of each Base Beam to keep them level during installation.

Locate the two bolts at the base of the side the cabinet. Use a 4mm Hex Key to remove the two bolts.

**Note:** If your Showpiece Cabinet has additional bolts in this area, remove them and the nuts on the other side through the rear access panel.

Align one of the Base Beams with the bolt holes. In the upper hole, use the ¼-20 x 50mm Screw that was originally removed from the hole. For the lower hole, use the ¼-20 x 30mm screw provided with this kit. Tighten both screws with a 4mm Hex Wrench. Be sure the screws are tightened securely, but do not over tighten.

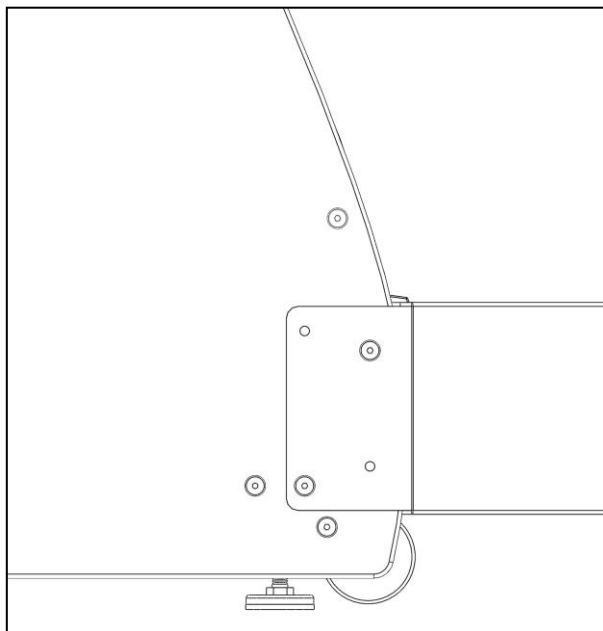

Attach the second Base Beam to the other side of the cabinet in the same manner. Remove the two lower cabinet screws, align the Base Beam with the bolt holes, prop up the opposite end so the Beam is level, and securely replace the appropriate screws.

Install the two rectangular Base Connector Plates to the top and bottom end surfaces of both brackets using 4 5/16-18 x ¾" Screws, 4 Lock Washers and 4 Hex Nuts. Orient the Base Connector Plates so the short end lines up with the edge of the Base Beam. Install and tighten the bolts furthest from the edge first.

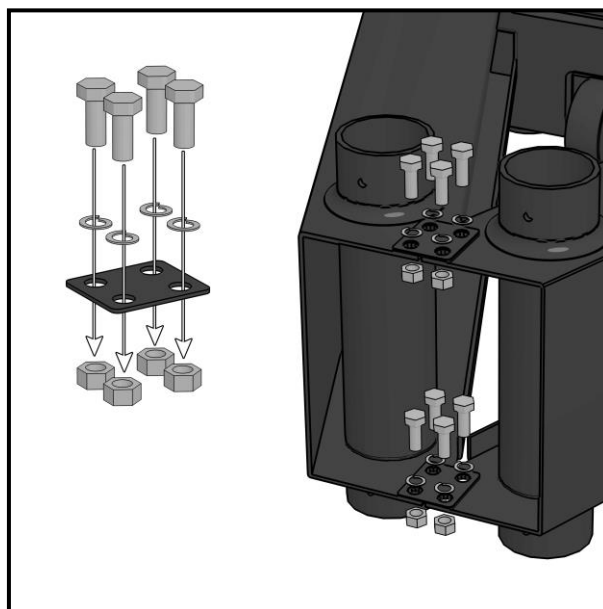

When installed properly, the brackets should be level with the ground, and flush against the backside of the cabinet to form a triangle.

## Step 2: Attach the Monitor Plate to Mounting Poles

Lay the two Vertical Poles on a clean flat surface, about 4 ¼" apart.

Place the Horizontal Monitor Plate on top of the poles. The flat surface on the plate should be flush with the poles. The small tabs on the ends of the plate should face up.

Align the 4 holes on the plate with the top 4 threaded holes on the poles. Secure the plate to the poles using the supplied 5/16-18 x ¾" Hex Screws and lock washers, using a ½" hex driver. Be sure the screws are tightened securely. Do not over tighten.

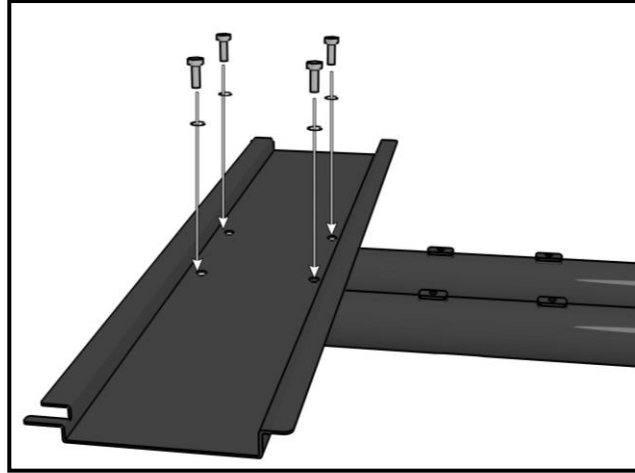

NOTE: If you wish to mount your monitor lower to the ground, attach the monitor plate to the lower sets of screw holes on the poles.

## Step 3: Attach Pole Assembly to Base Beams

Carefully lift the pole assembly and insert the bottom ends of the tubes into the pipe sleeves on the Base Beams. The vertical poles should rest on the floor.

Make sure the monitor plate is level and parallel to the Showpiece cabinet.

Insert the four ¼-28 x ½" screws and secure the poles to the Base with a 7/16" hex socket or open end wrench. Tighten all screws securely but take care not to over tighten.

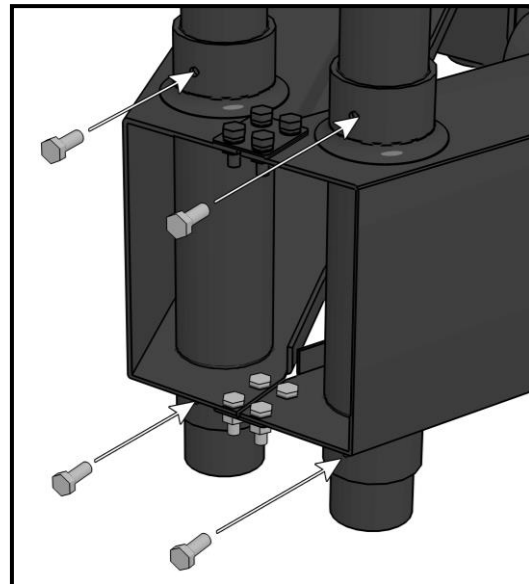

## Step 4: Attach Vertical & Marquee Brackets to HDTV

Carefully place your HDTV screen face down on a flat, smooth, and clean surface. A soft cloth or sheet is recommended to prevent scratching the screen.

The Vertical Brackets have been designed to work with most hole patterns found on HDTVs. If the holes on your HDTV do not line up with the vertical brackets, do not use this stand.

Place the Vertical Brackets on the back of the HDTV and align to the proper mounting holes. The Brackets should be evenly spaced from the center of the back of the screen.

Align the two Marquee Brackets (supplied with Showpiece Cabinet) with the holes at the top of the Vertical Brackets. Select the proper hole on the Marquee Bracket that best suits your display. Use a Phillips screwdriver to attach the appropriate supplied screws. Be sure all of the brackets are straight and secure.

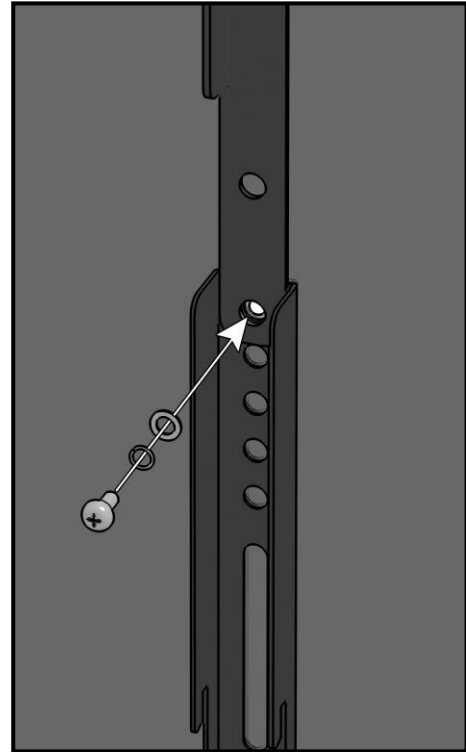

Once positioned, attach the vertical brackets with the appropriate combination of screws and washers designed for your screen. Tighten screws so the brackets are firmly secured, but take care not to overtighten or stress your hardware.

Note: The number of fasteners used will vary depending on the type and size of screen. Washers may not be needed depending on the type of screen. Screw sizes vary from screen to screen. Be sure to use the correct screw size recommended by your TV manufacturer. Always use the top and bottom holes on the screen to secure the brackets.

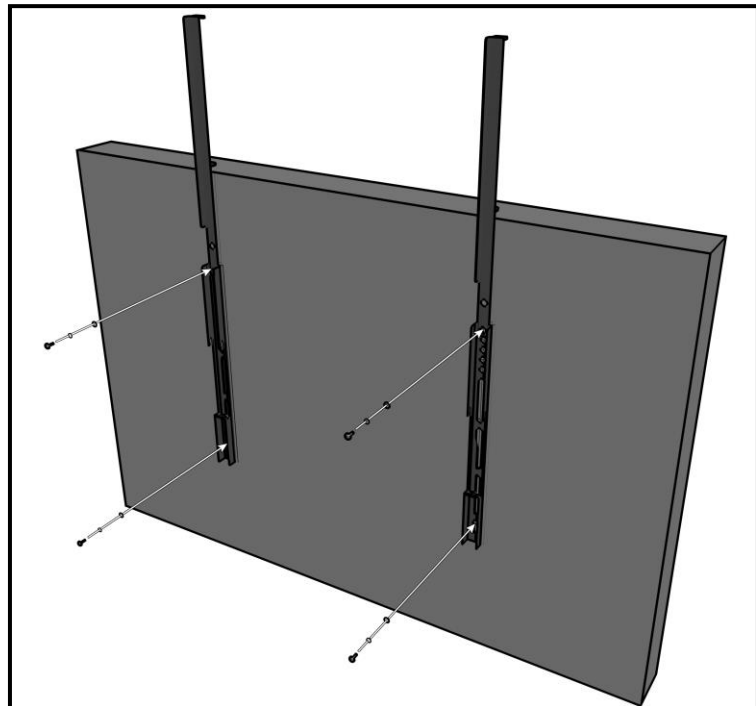



## Step 5: Mount HDTV to Monitor Plate

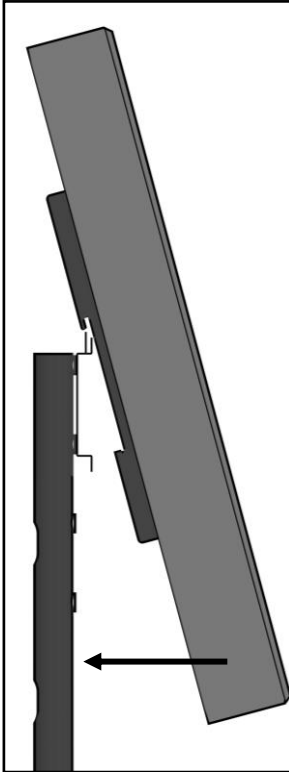

Use an assistant to carefully lift the HDTV and position it in front of the Monitor Bracket. Hook the two Vertical Brackets onto the top bar of the Horizontal Monitor Plate, then slowly swing the screen down and into place against the lower bar of the plate.

Use a flat screwdriver or ¼" hex driver to lock the screen into place by inserting two 8-32 x 1¼" screws onto the bottom of the Vertical Bracket, and tighten firmly against the Monitor Plate.

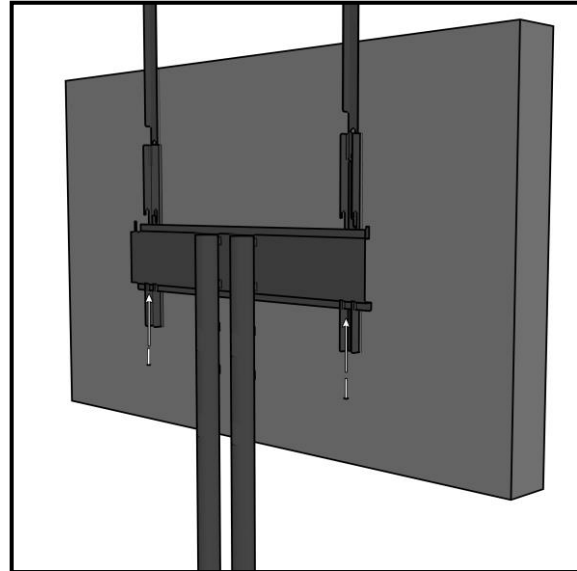

## Step 6: Attach Marquee Assembly

Position Marquee assembly (shipped with Showpiece Cabinet) onto the Marquee Brackets so the bracket rests inside the channel on the marquee frame. Be sure the marquee is centered above the HDTV.

